

ORTHOPEDIC DRESSING INSTRUMENTS

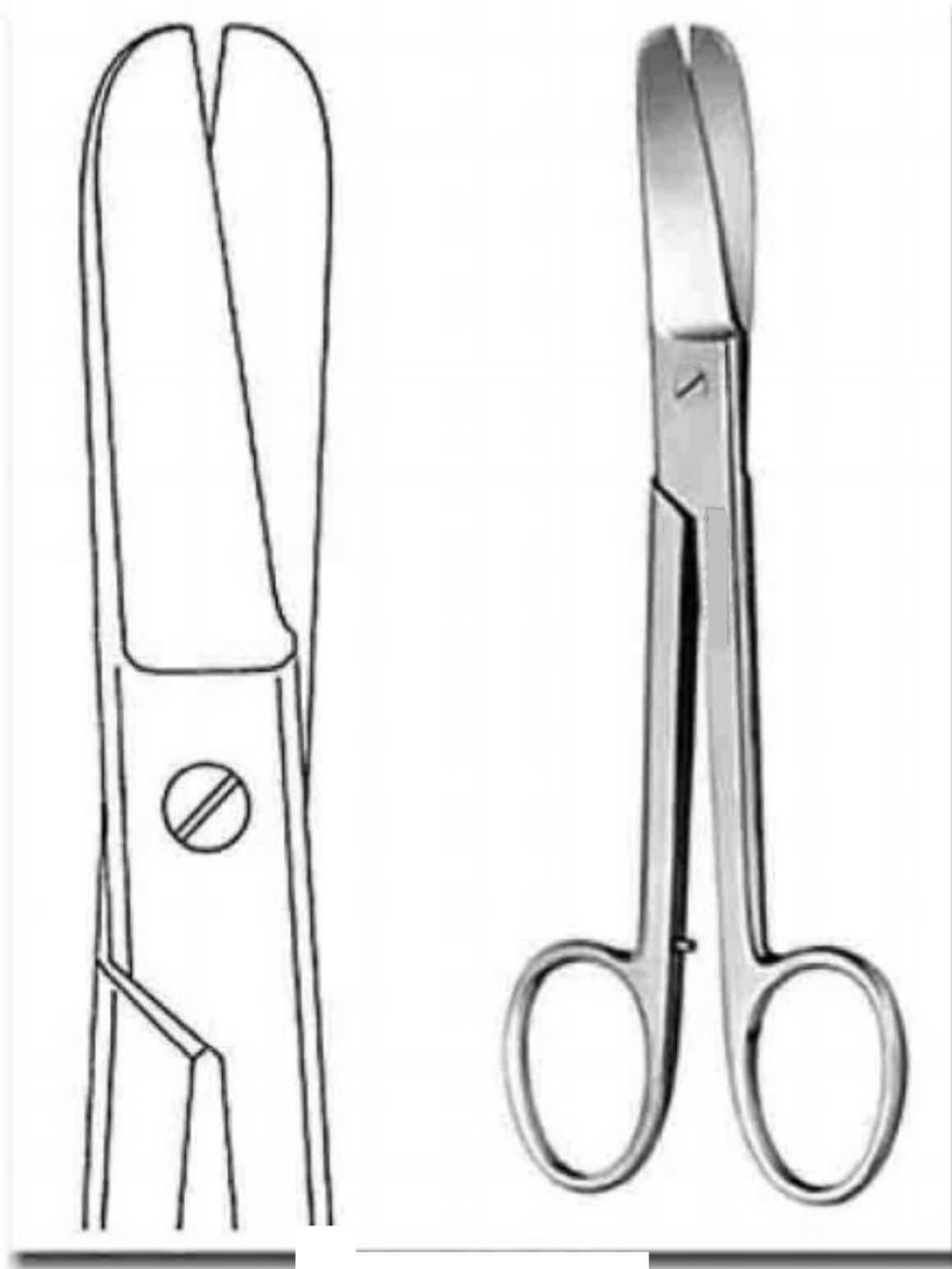

AJ-2036

Lorenz Bandage Scissors
Heavy Pattern (23 cm / 9")

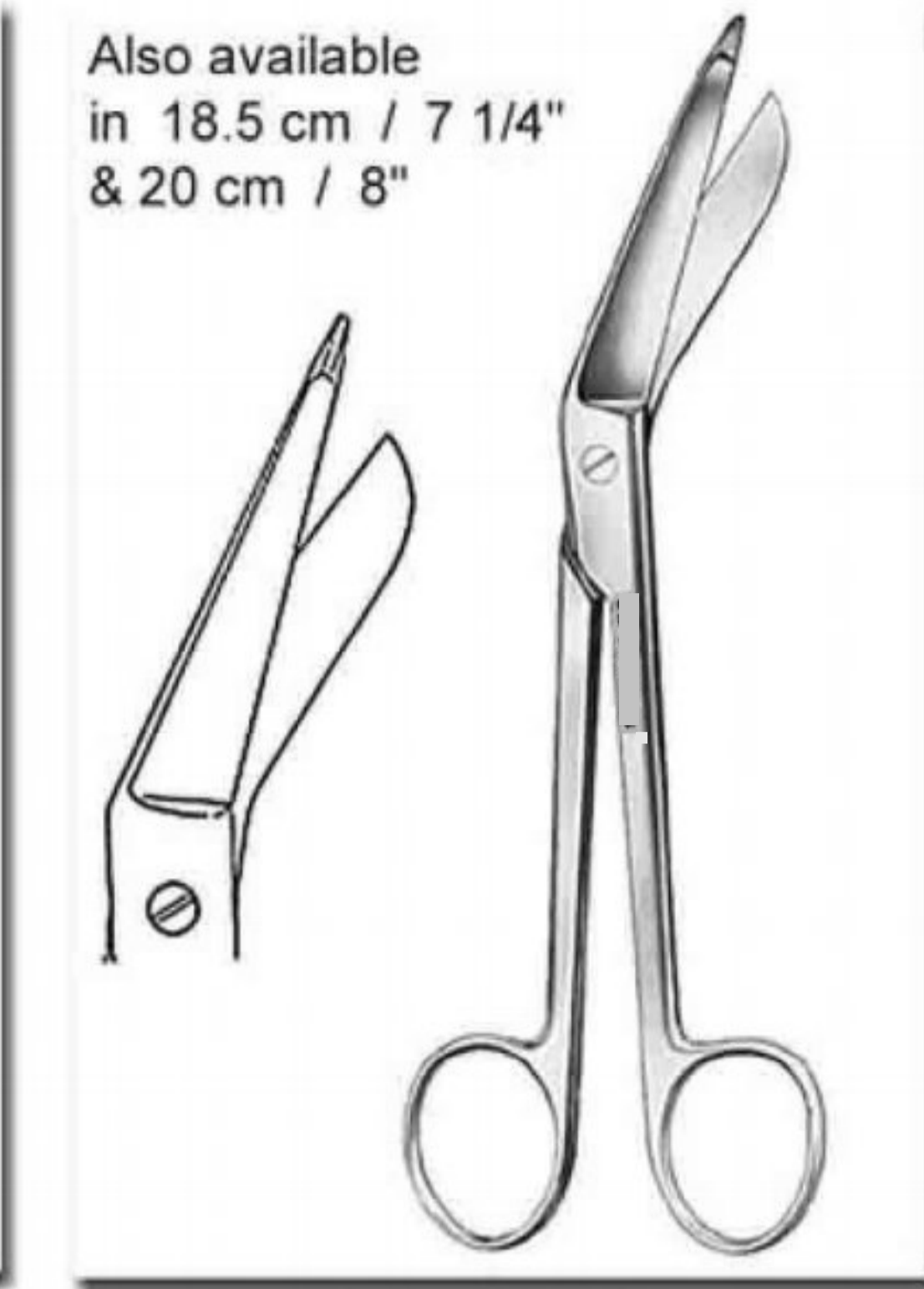

Also available
in 18.5 cm / 7 1/4"
& 20 cm / 8"

AJ-2037

Lister Bandage Scissors
14.5 cm / 5 3/4"

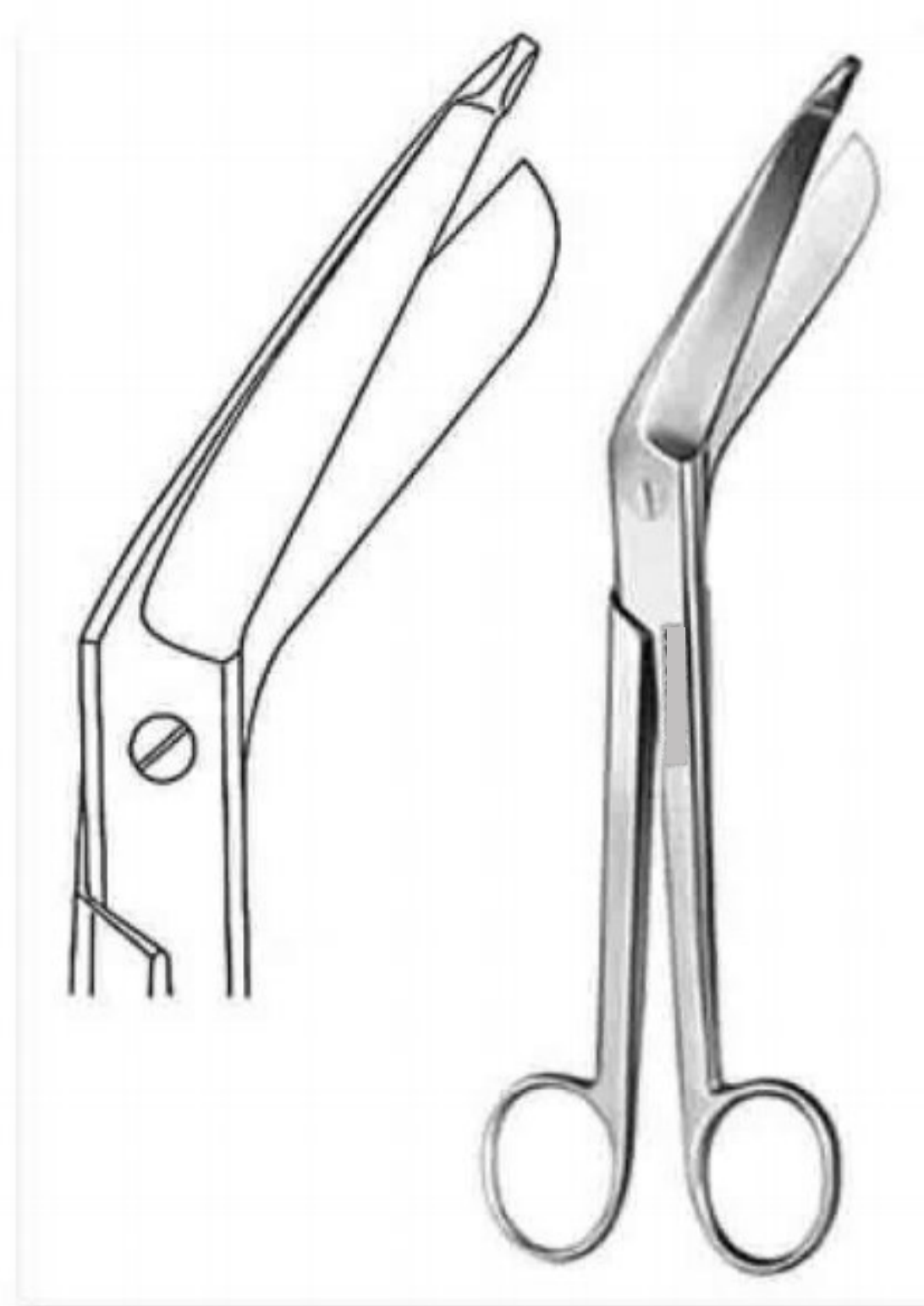

AJ-2038

Bergmann Plaster Shears
Heavy Pattern
23.5 cm / 9 1/4"



AJ-2039

Esmarch Plaster Shears
Heavy Pattern, Short Blades
20 cm / 8"



Also available
in 18cm / 7 1/2"

AJ-2040

Bandage Scissors
16 cm / 6 1/4"
Black Plastic Rings

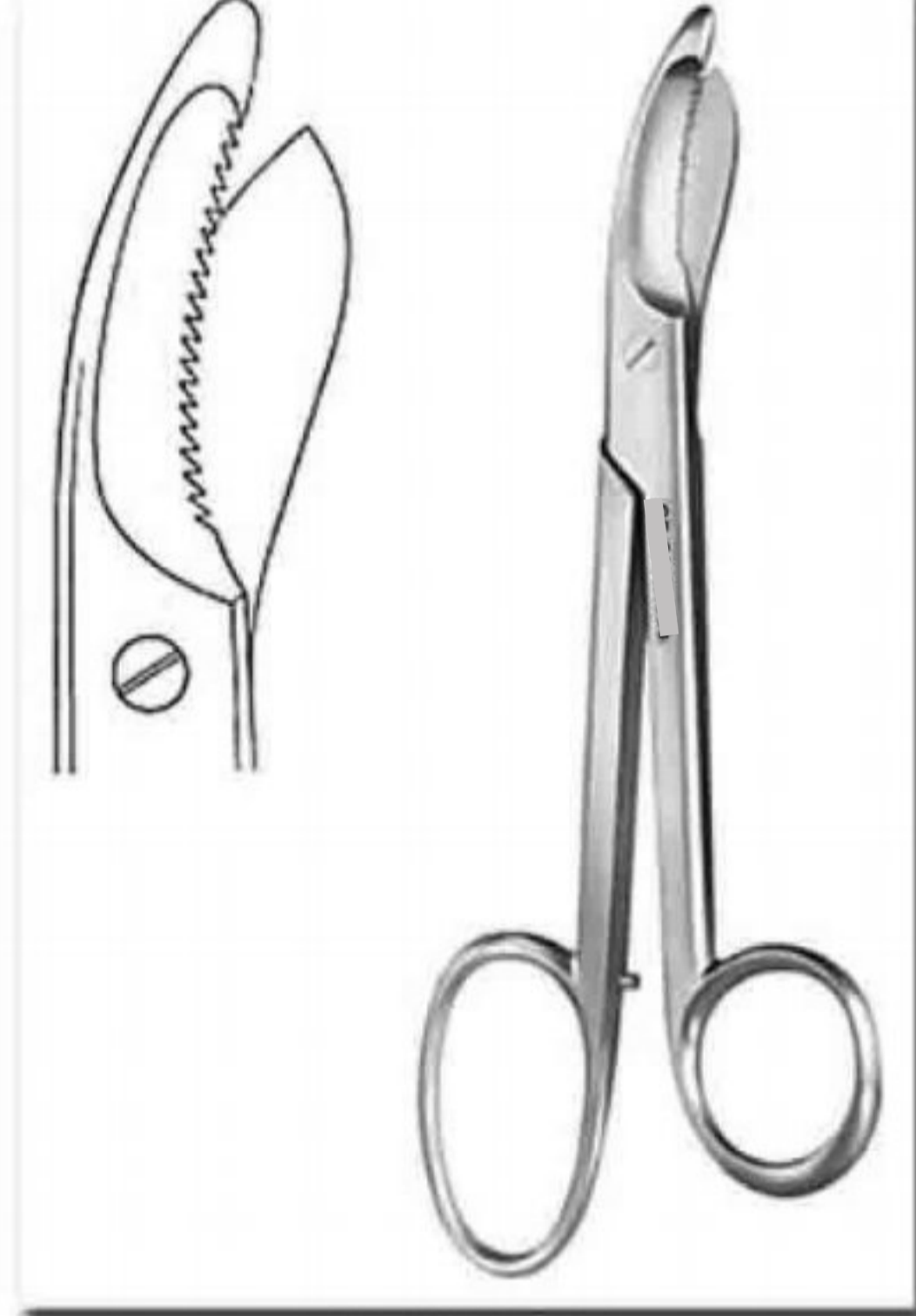

AJ-2041

Bruns Plaster Scissors
24 cm / 9 1/2"
One Serrated Cutting Edge



B: 26 cm / 10"
C: 38 cm / 15"

AJ-2042

Stille-Martin
Plaster Shears
A: 23 cm / 9"



AJ-2043

Engel Plaster Saw 15.5 cm / 6"



AJ-2044

Hopkins Plaster Knife
20 cm / 8"
with Wooden Handle



AJ-2045

Esmarch
Plaster Knife
18 cm / 7"



AJ-2046

Reiner
Plaster Knife
18 cm / 7"



AJ-2047

Martin
Plaster Knife
21 cm / 8 1/4"
with wooden handle



AJ-2048

Engel Plaster Saw 15.5 cm / 6"

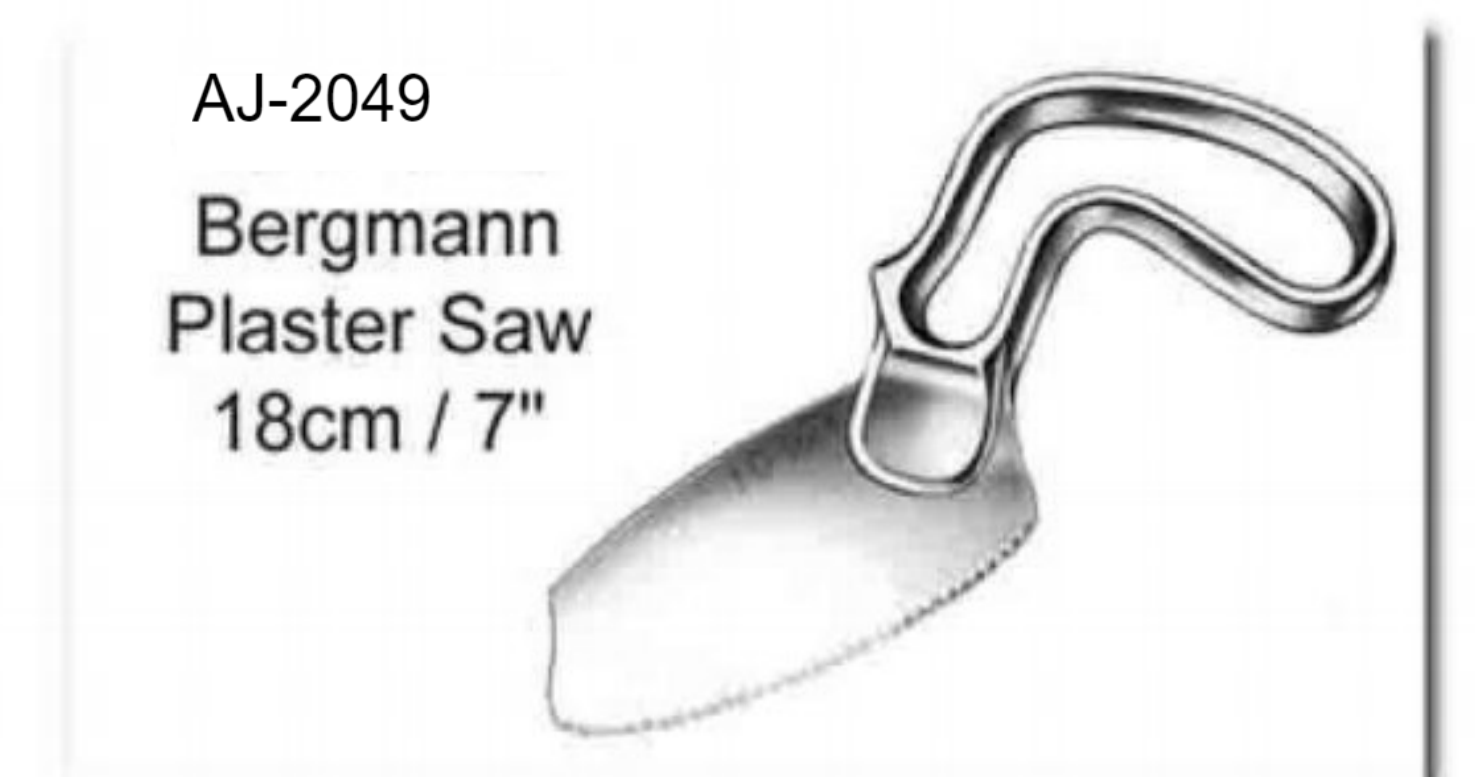

AJ-2049

Bergmann
Plaster Saw
18cm / 7"

PLASTER CAST INSTRUMENTS

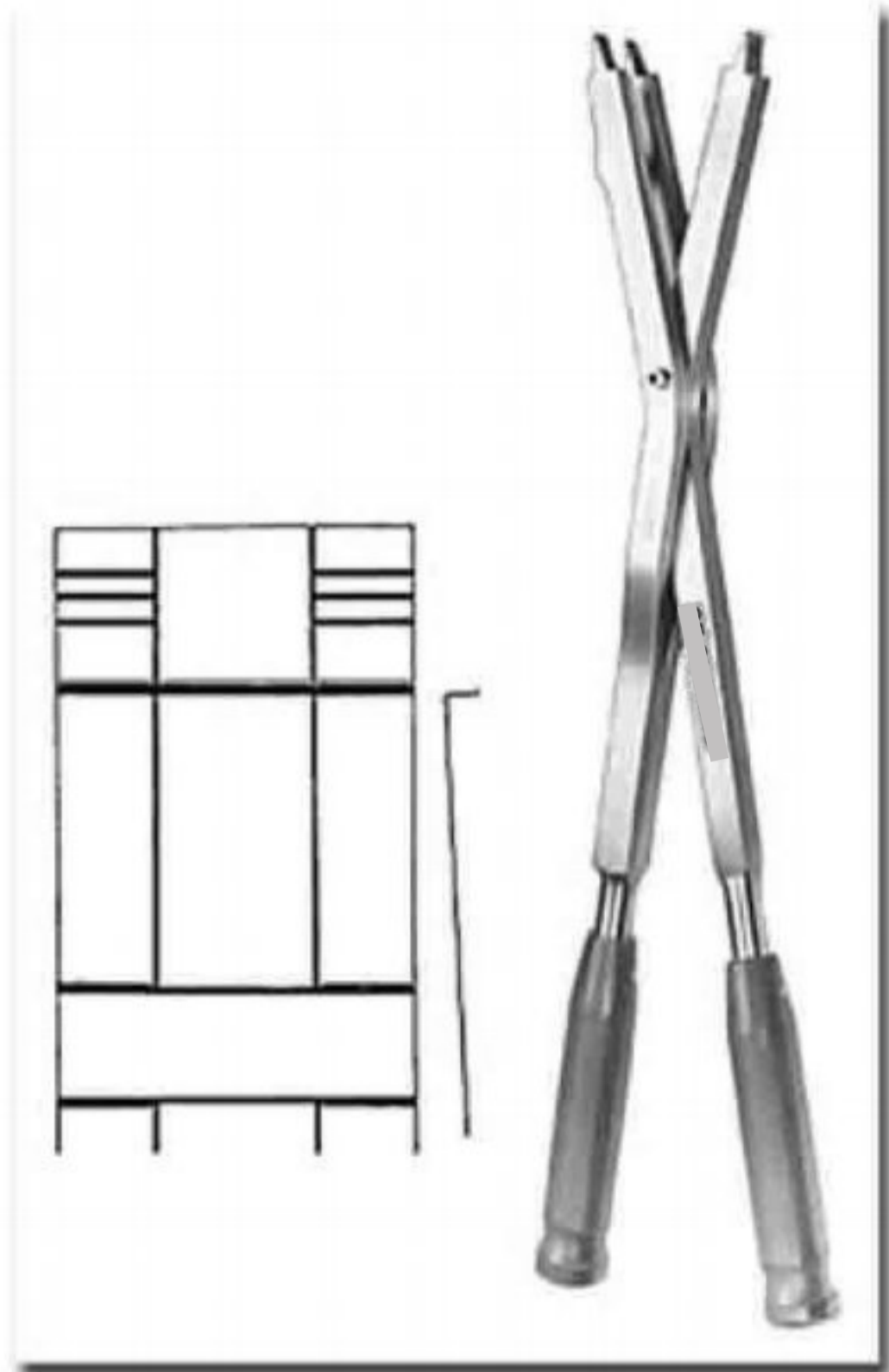

AJ-2050
Hermann Plaster Spreader
48 cm / 19" Heavy Pattern

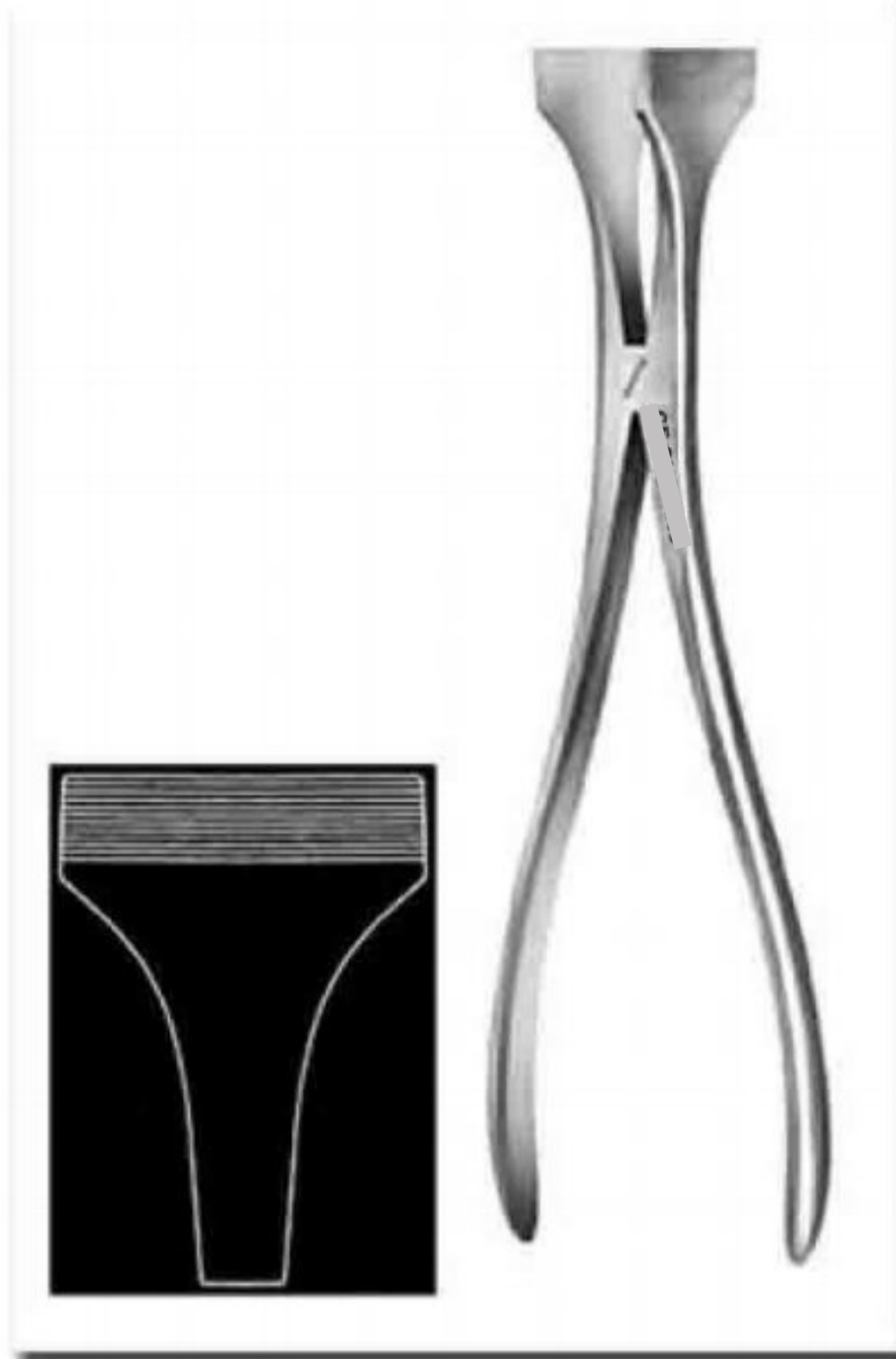

AJ-2051
Hennig Plaster Spreader
28 cm / 11"

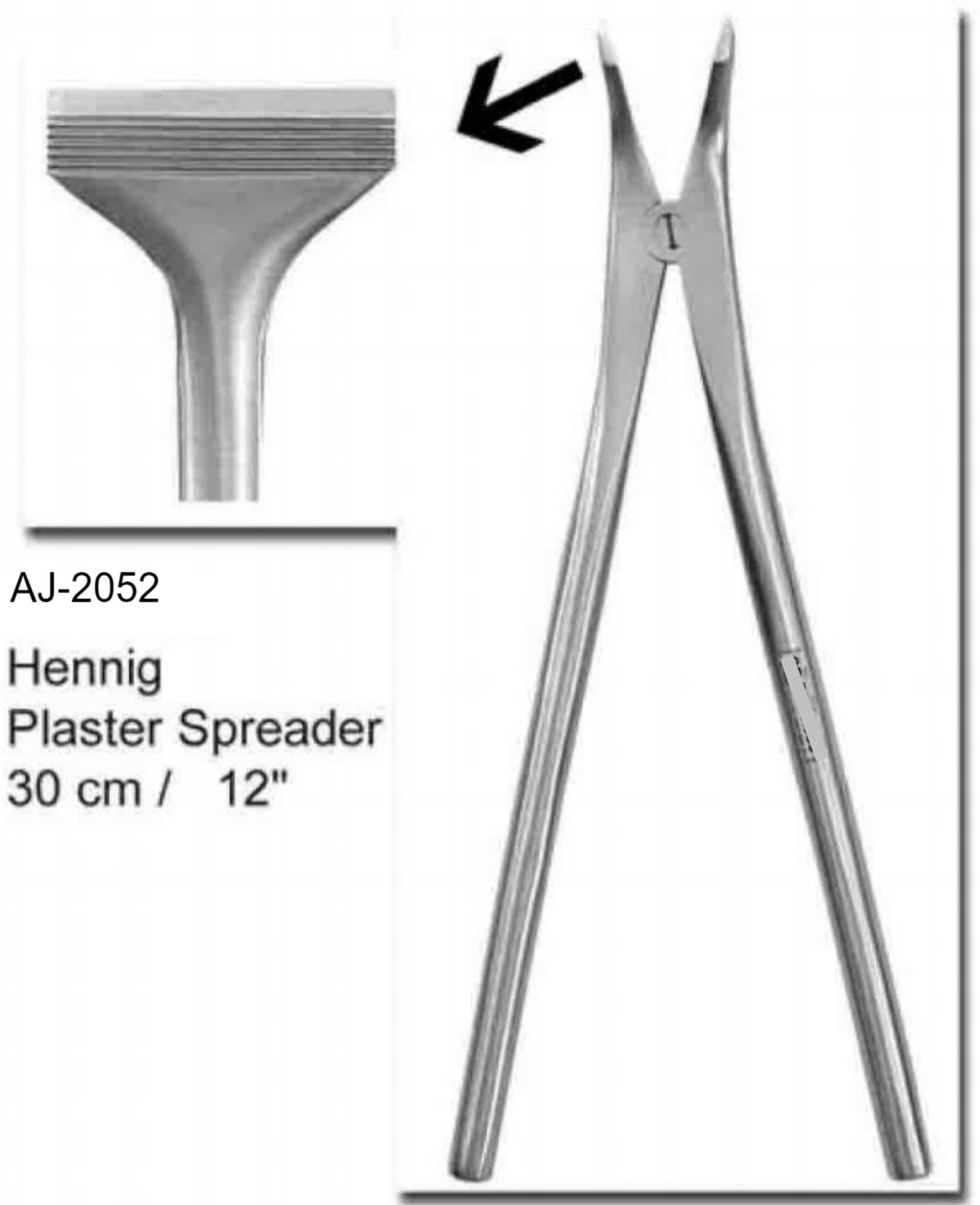

AJ-2052
Hennig
Plaster Spreader
30 cm / 12"



AJ-2053
Beeson Plaster Spreader
1.5 In Blade
30 cm / 12"



AJ-2054
Walton Plaster Spreader
w/Spring 3 Prongs
23 cm / 9"

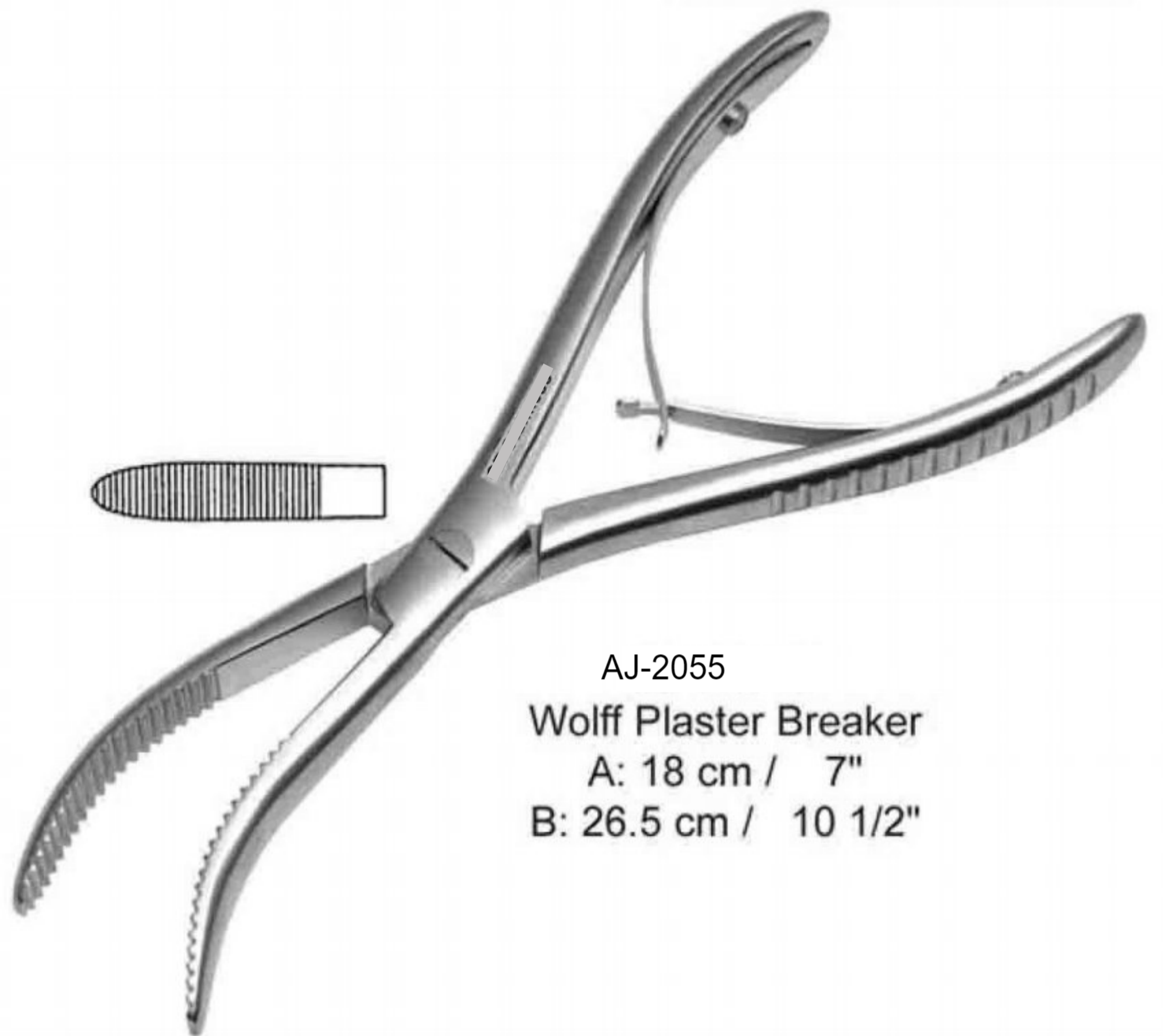

AJ-2055
Wolff Plaster Breaker
A: 18 cm / 7"
B: 26.5 cm / 10 1/2"

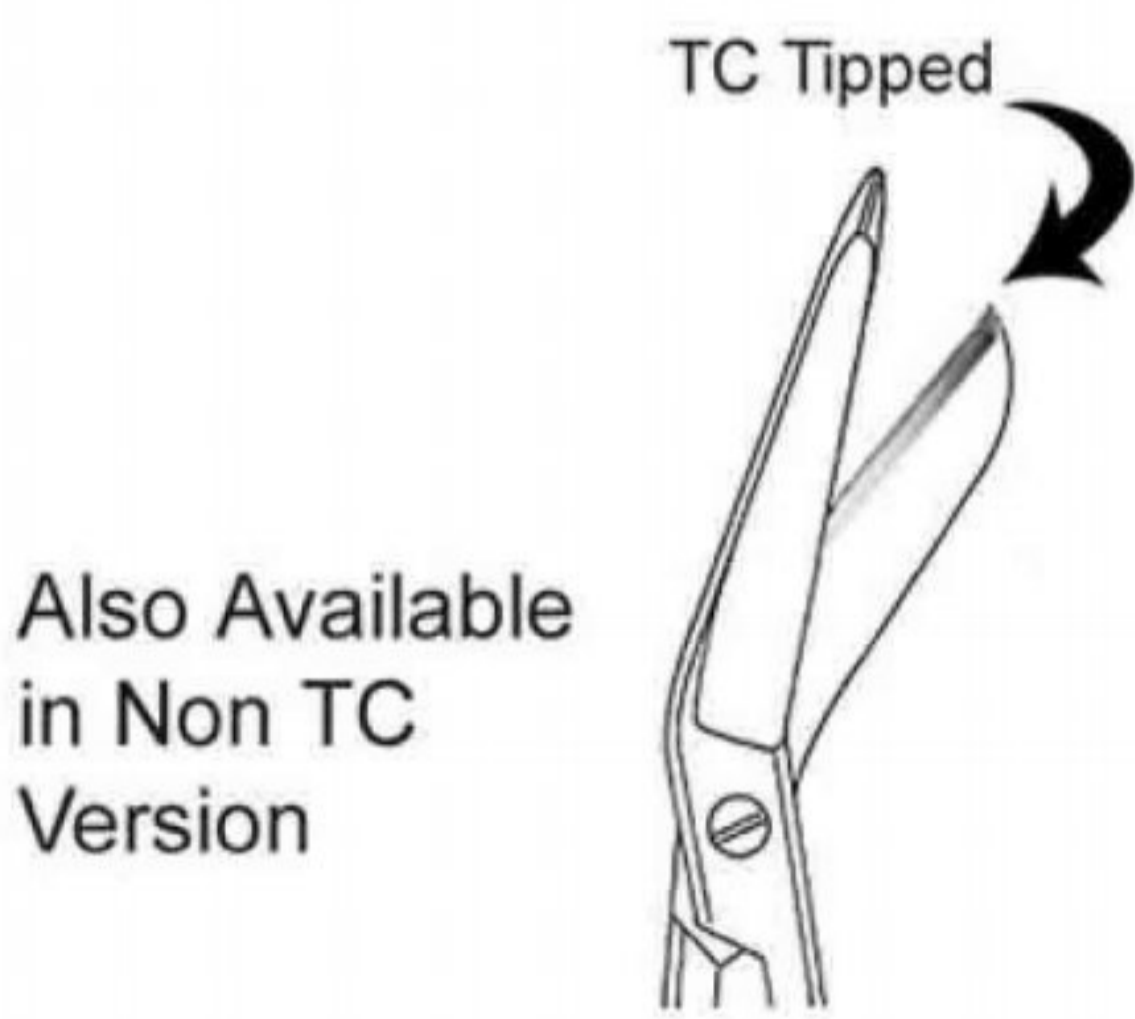

Also Available
in Non TC
Version

AJ-2056
Lister
Bandage Scissors
TC / Handle gold
18 cm / 7"



AJ-2057
Bruns
Plaster Scissors
24 cm / 9 1/2"
Also Available
in Non TC
Version



AMPUTATION SAWS - GIGLI SAW

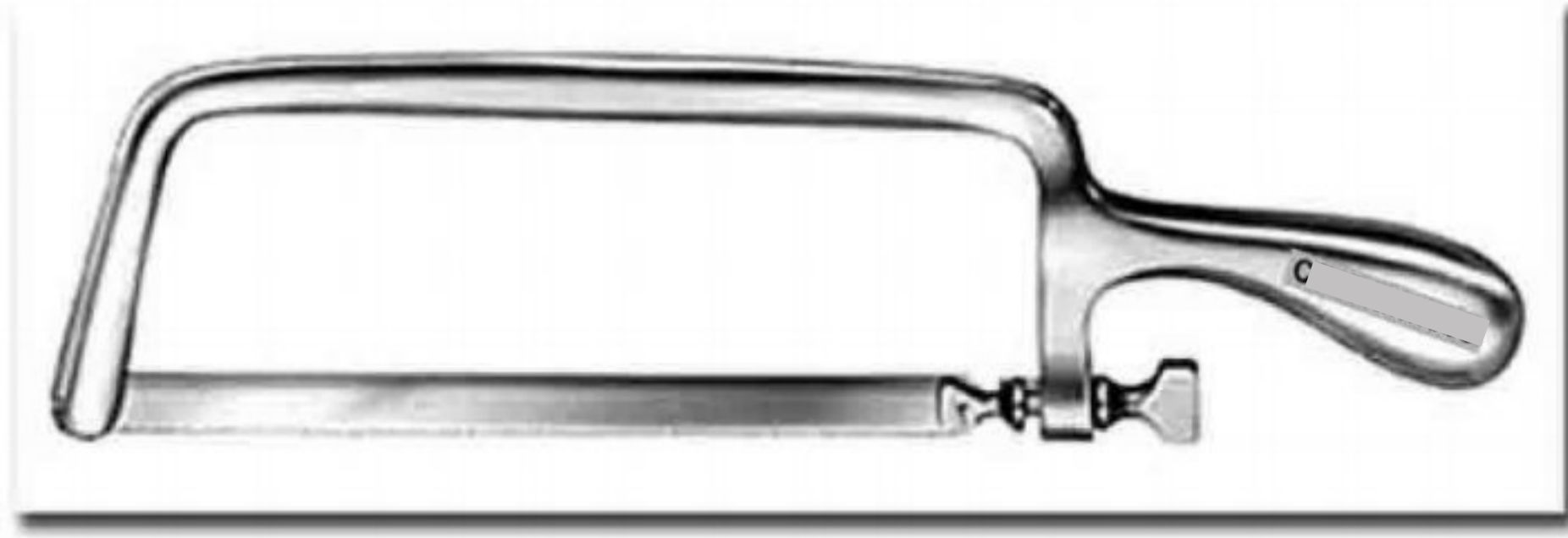

AJ-2058 Charrière Amputation Saw
35 cm / 13 3/4"

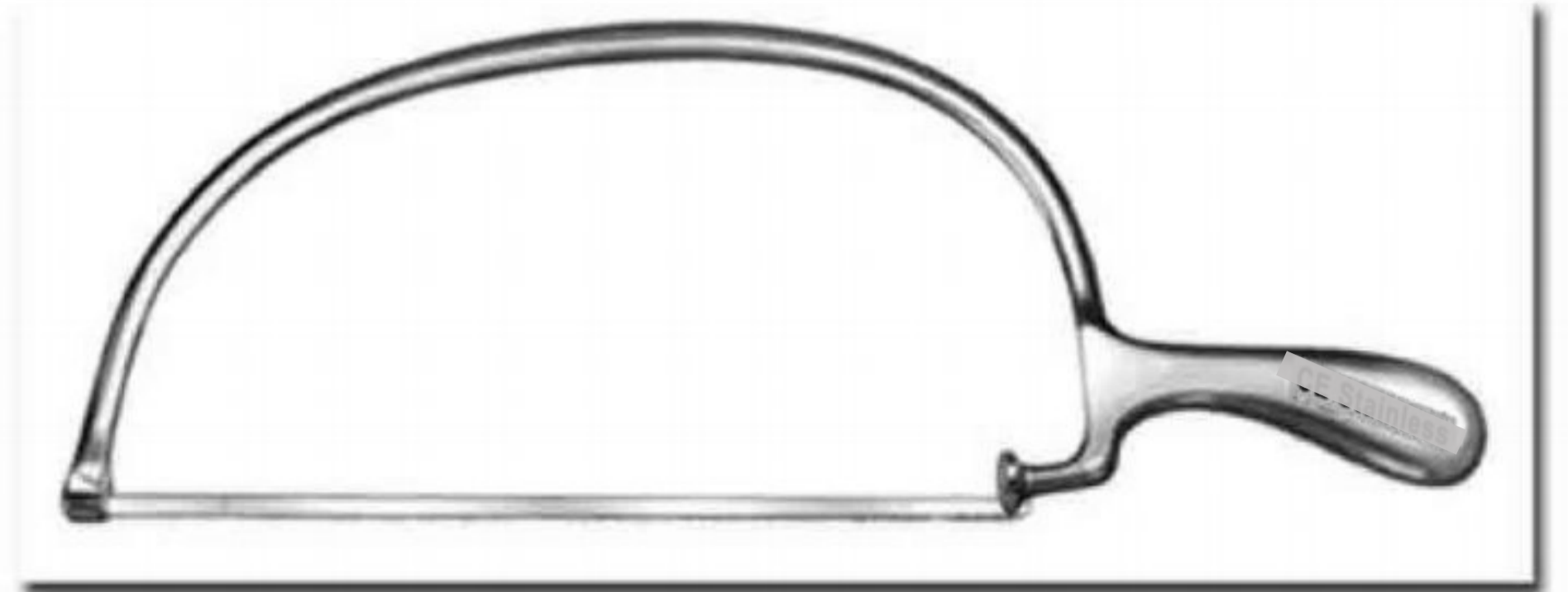
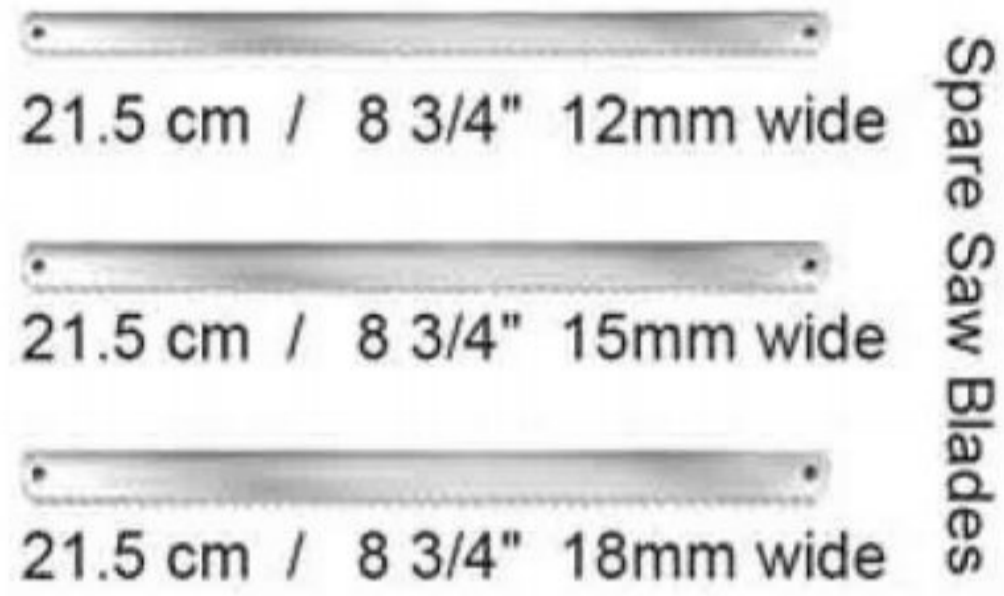

AJ-2059 BIER Amputation Saw
40.5 cm / 16"

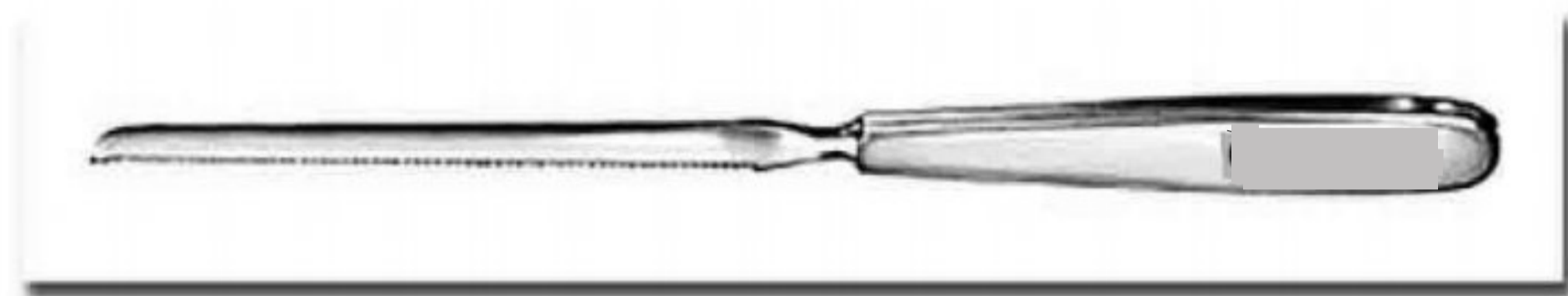
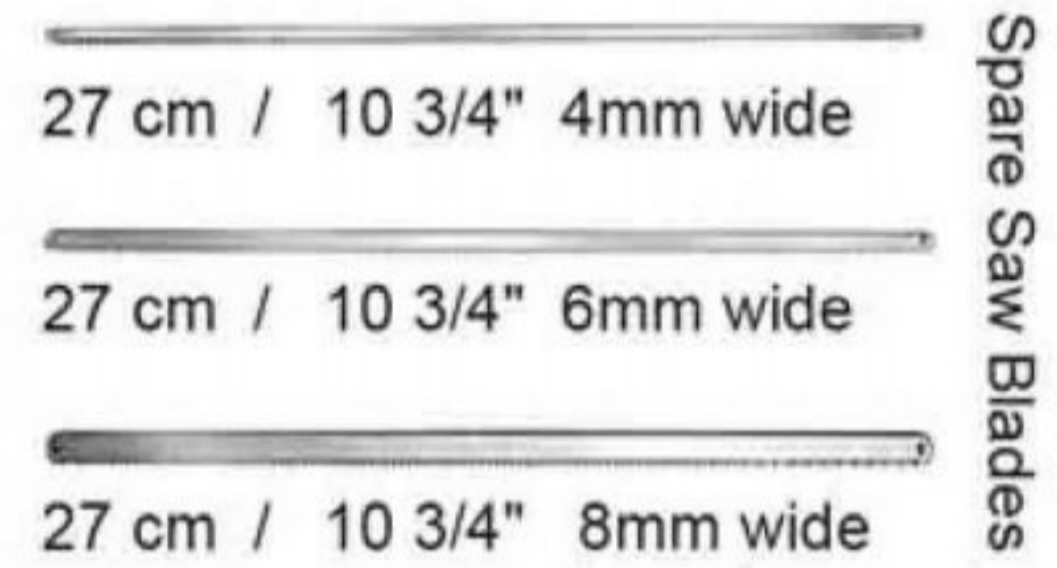

AJ-2060 Langenbeck Amputation Saw
24.5 cm / 9 3/4"

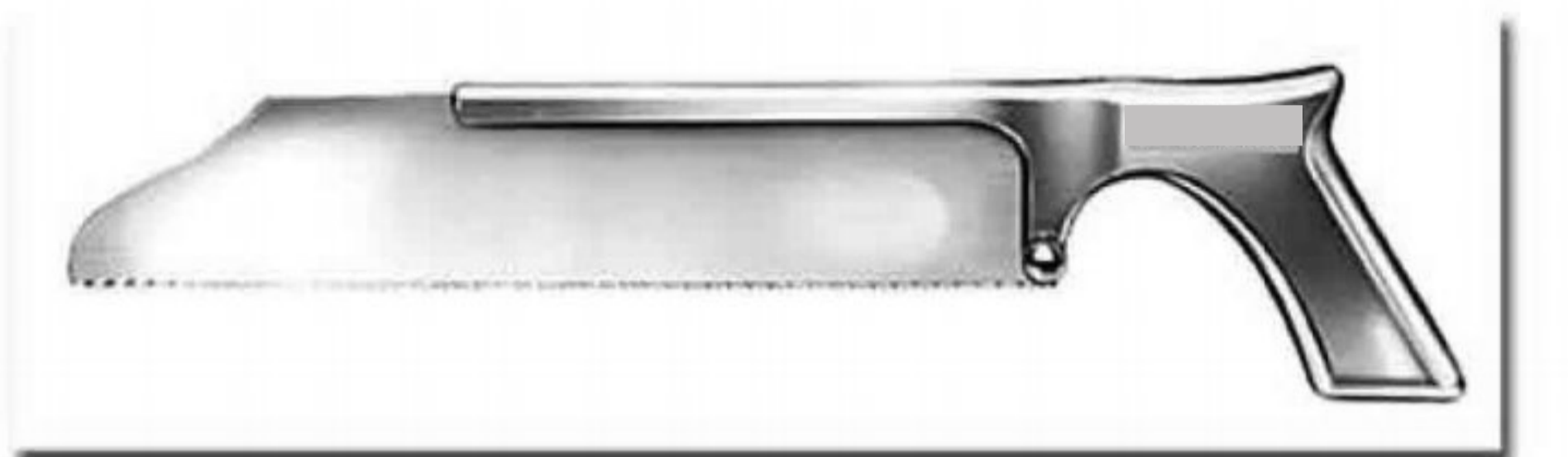

AJ-2061 Satterlee Amputation Saw 29 cm / 11 1/2"
Also: Spare Saw Blade Available in 20 cm / 8 1/4" Size

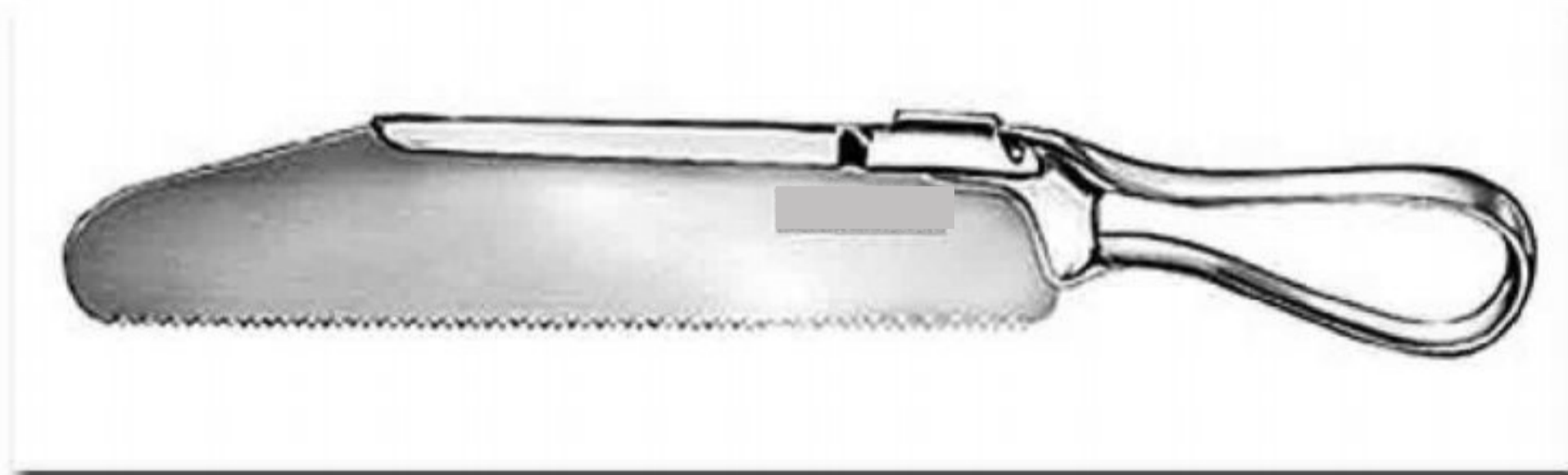

AJ-2062 Charrière Amputation Saw 27 cm / 10 1/2"



AJ-2063 Satterlee Amputation Saw 23 cm / 9"

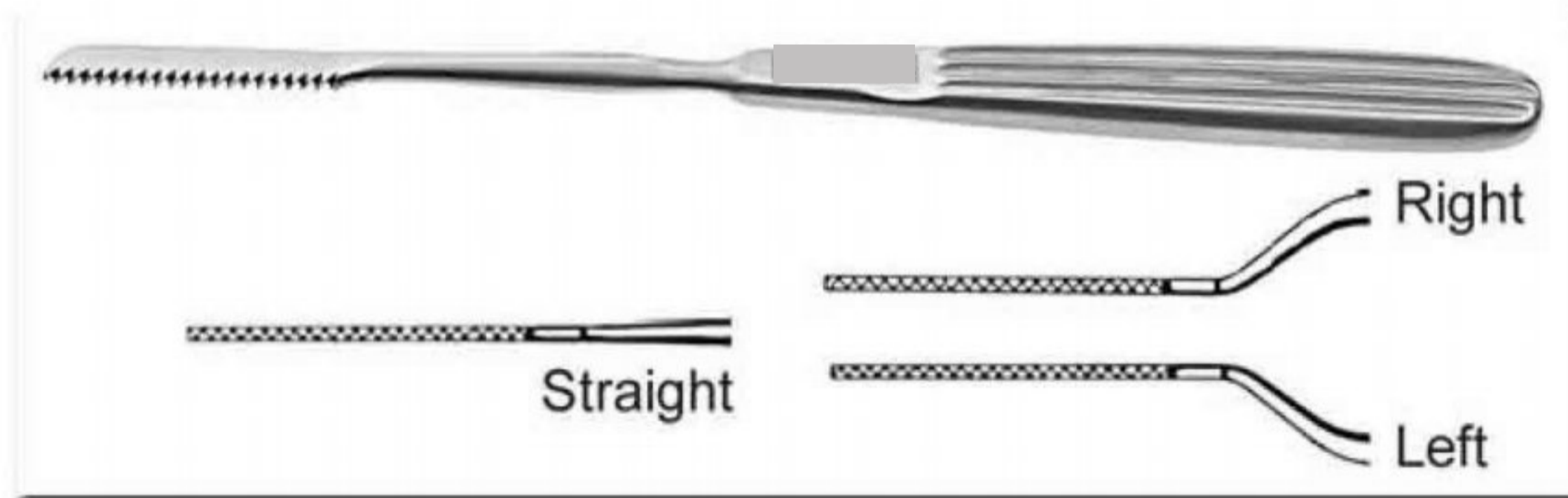

AJ-2064 Joseph Amputation Saw 18 cm / 7"

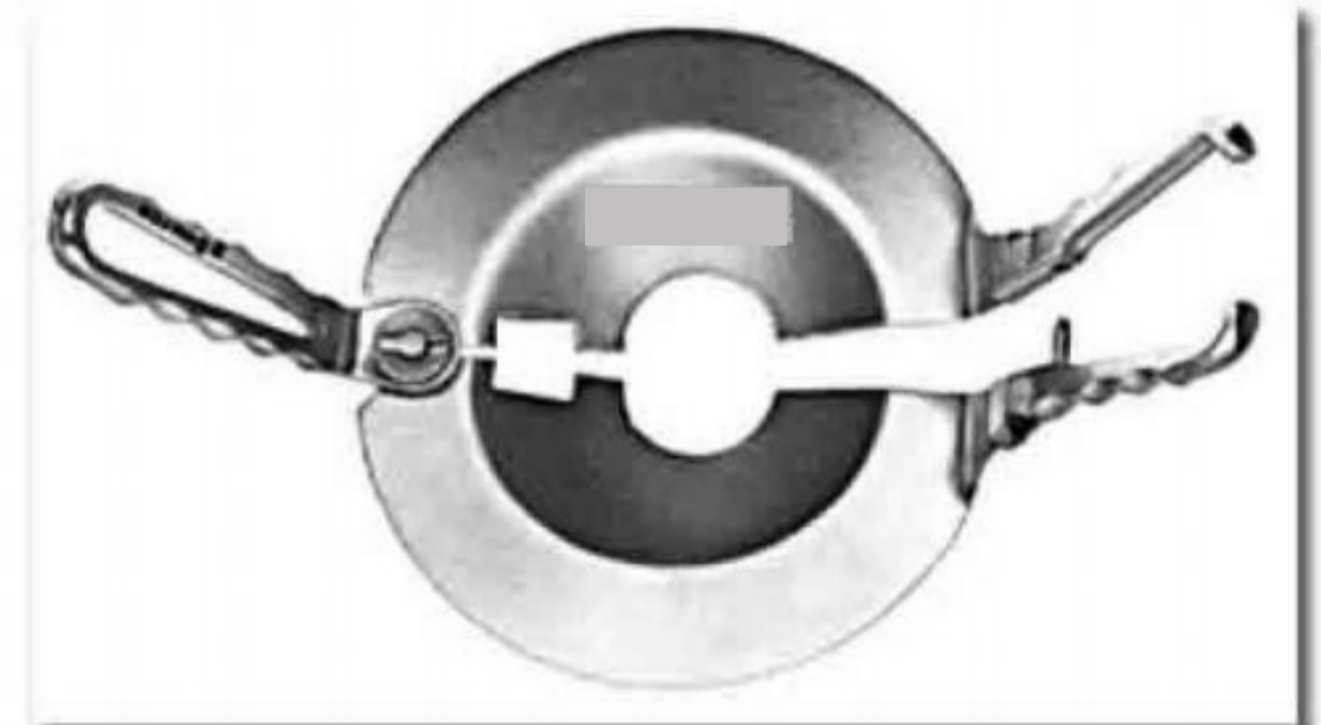

AJ-2065 Percy Amputation Shield 30 cm / 12"

AJ-2066

- A: Gigli Saw 30cm
- B: Gigli Saw 50cm
- C: Tyler Gigli Saw (Large Cut) 30cm
- D: Tyler Gigli Saw (Large Cut) 30cm

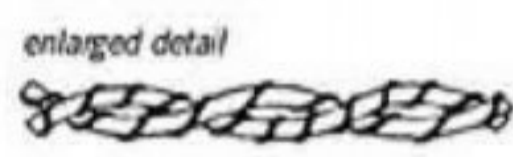

AJ-2067 Gigli
Sold in Pair

AJ-2068 Struly Gigli
Sold in Pair



AJ-2069 Gigli
Sold in Pair

AJ-2070 Struly Gigli
Sold in Pair

30-135-30
BAILEY Gigli Saw Guide 30cm

30-136-28
POPPEY Gigli Saw Guide 28cm

REAMERS - AWLS - BONE HOOKS



AJ-2073
Reamer
13.5 cm / 5 1/4"



AJ-2074
Perthes Reamer
18 cm / 7"



AJ-2075
Perthes Reamer
21.5 cm / 8 1/2"



AJ-2076
Reamer
One concave side
14 cm / 5 1/2"

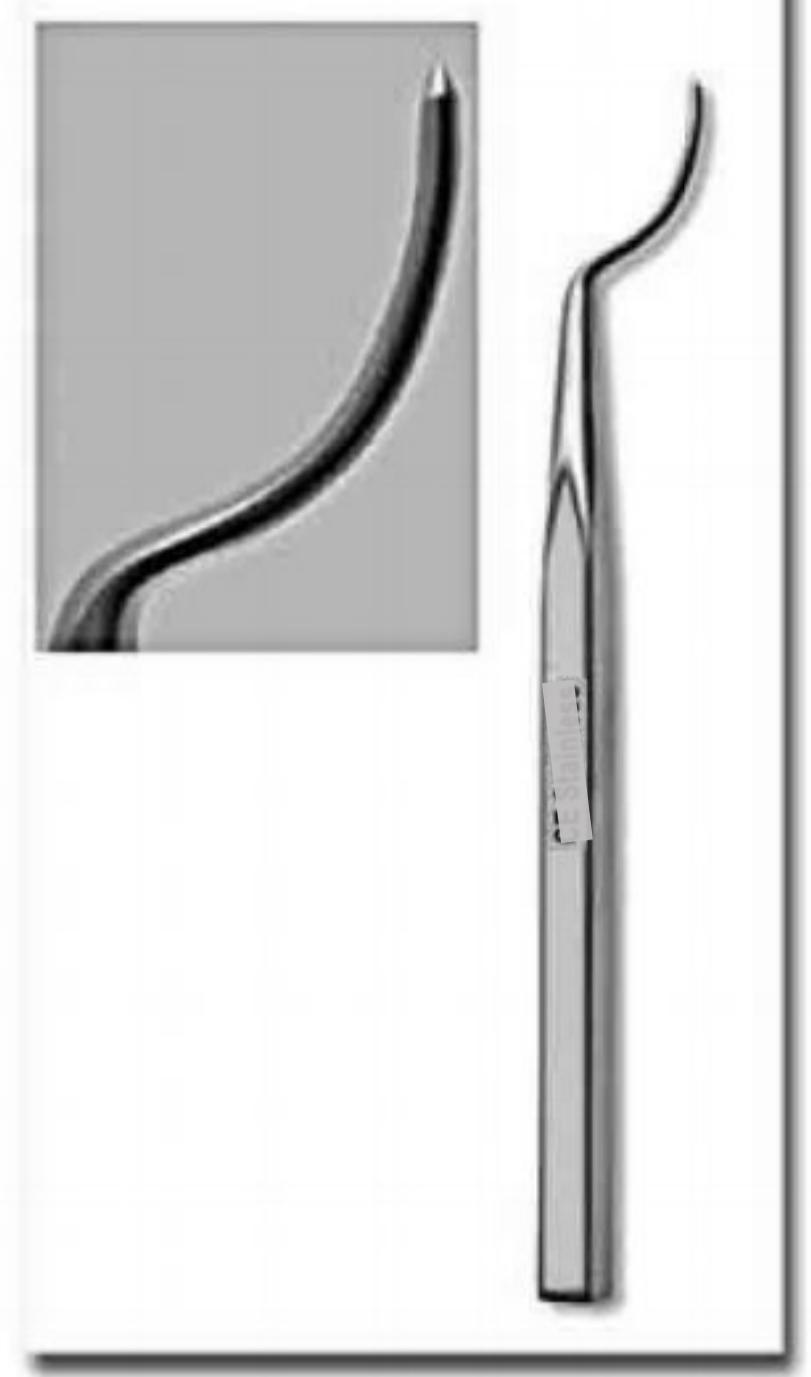

AJ-2077
Glenoid Punch
20cm / 8"

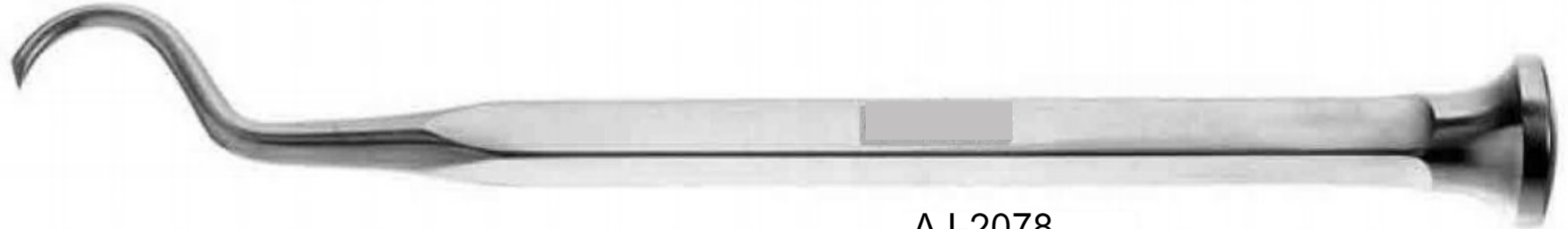
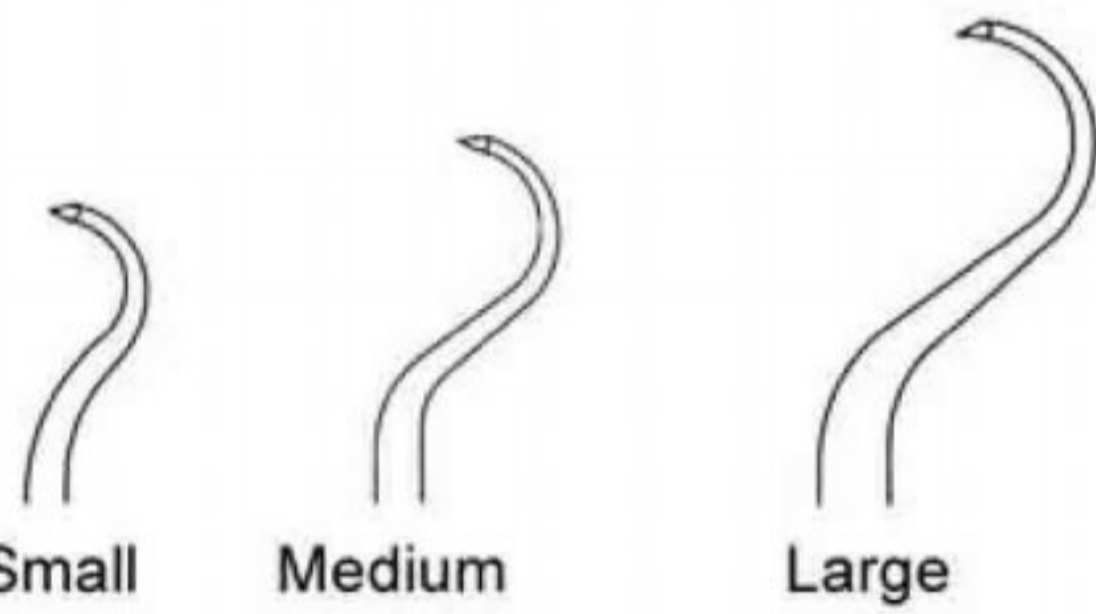

AJ-2078
Shoulder Percussion Awl
A: 21.5cm / 8 1/2" B: 23.5cm / 9 1/4"



AJ-2081
Shoulder Penetrating Awl
Fibre Handle
A: 18cm / 7"
B: 23cm / 9"



AJ-2079
Kuntscher Diamond Awl 28cm / 11"

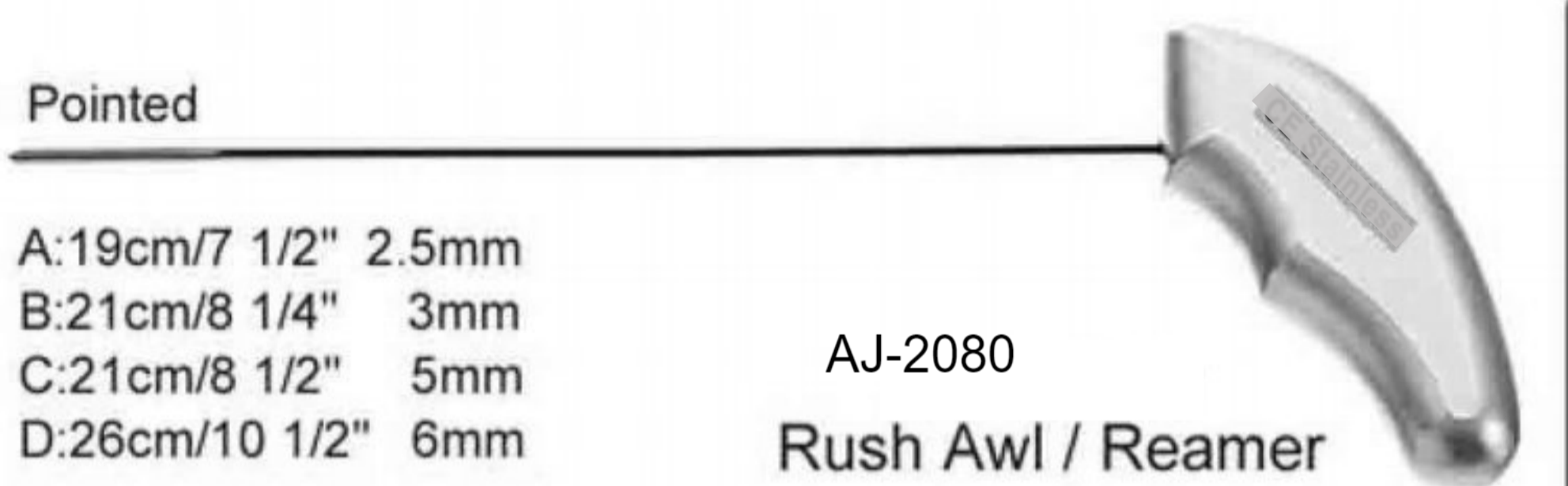

Pointed
A: 19cm / 7 1/2" 2.5mm
B: 21cm / 8 1/4" 3mm
C: 21cm / 8 1/2" 5mm
D: 26cm / 10 1/2" 6mm
AJ-2080
Rush Awl / Reamer

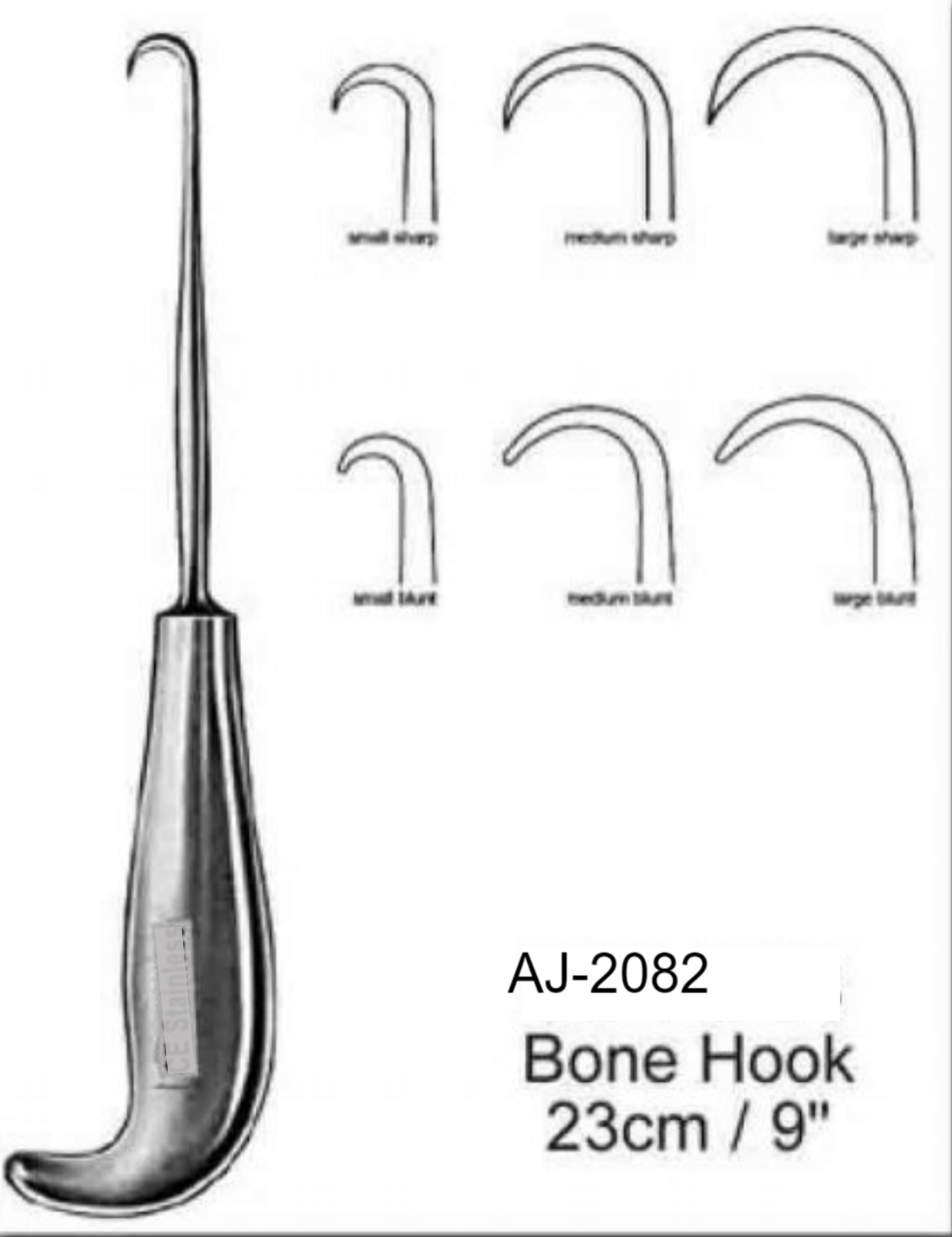

AJ-2082
Bone Hook
23cm / 9"

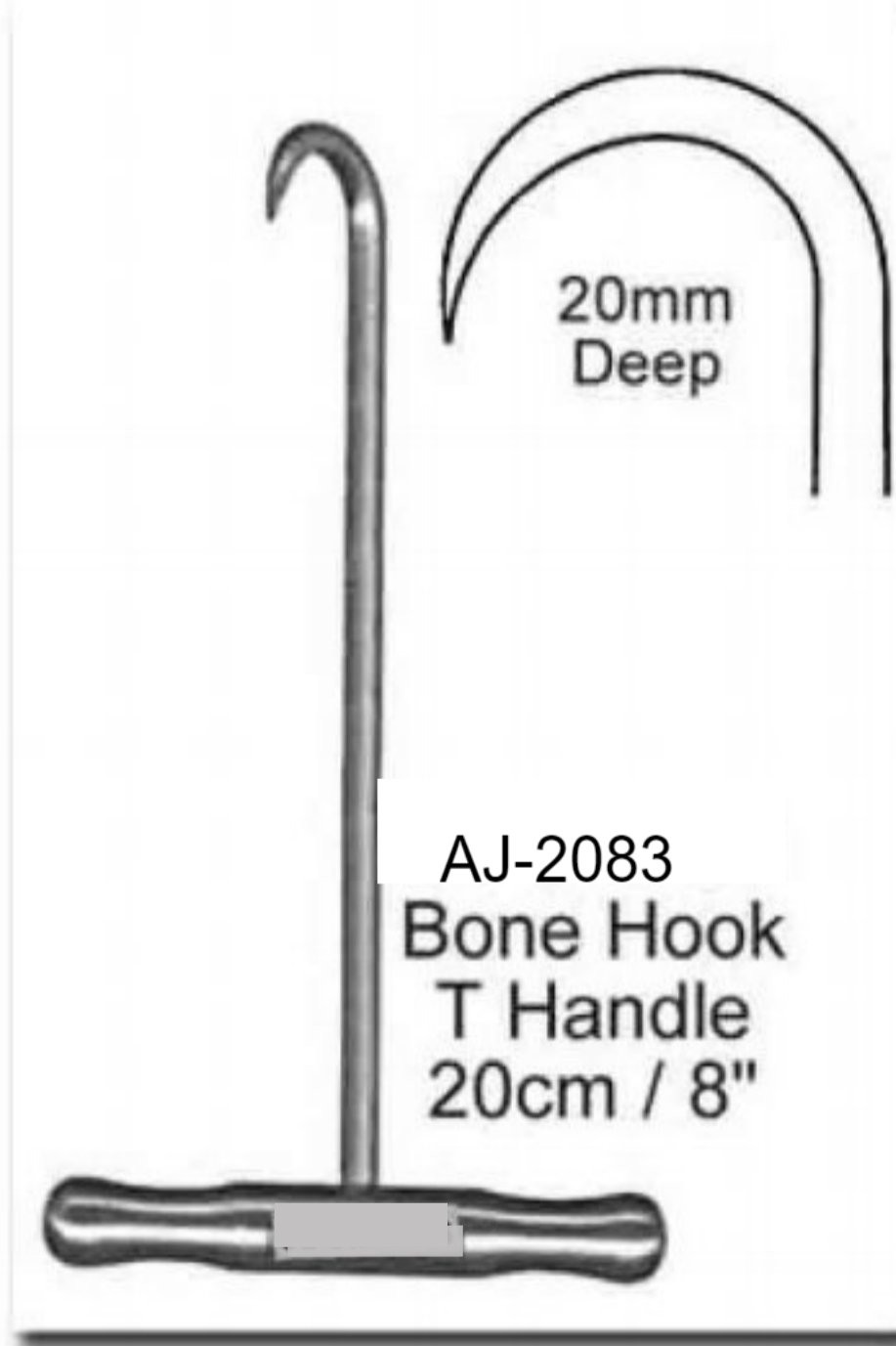

AJ-2083
Bone Hook
T Handle
20cm / 8"



AJ-2084
Bone Hook T Fibre Handle
14cm / 5 5/8"



AJ-2086
Pointed Awl
Fibre Handle
25cm / 10"



AJ-2085 Volkman Bone Hook

A: 20cm / 8"
19X27mm
Sharp

B: 23cm / 9"
15X20mm
Blunt

C: 23cm / 9"
15X20mm
Sharp

C: 25cm / 9 3/4"
15X20mm
Sharp

HAND BONE DRILLS

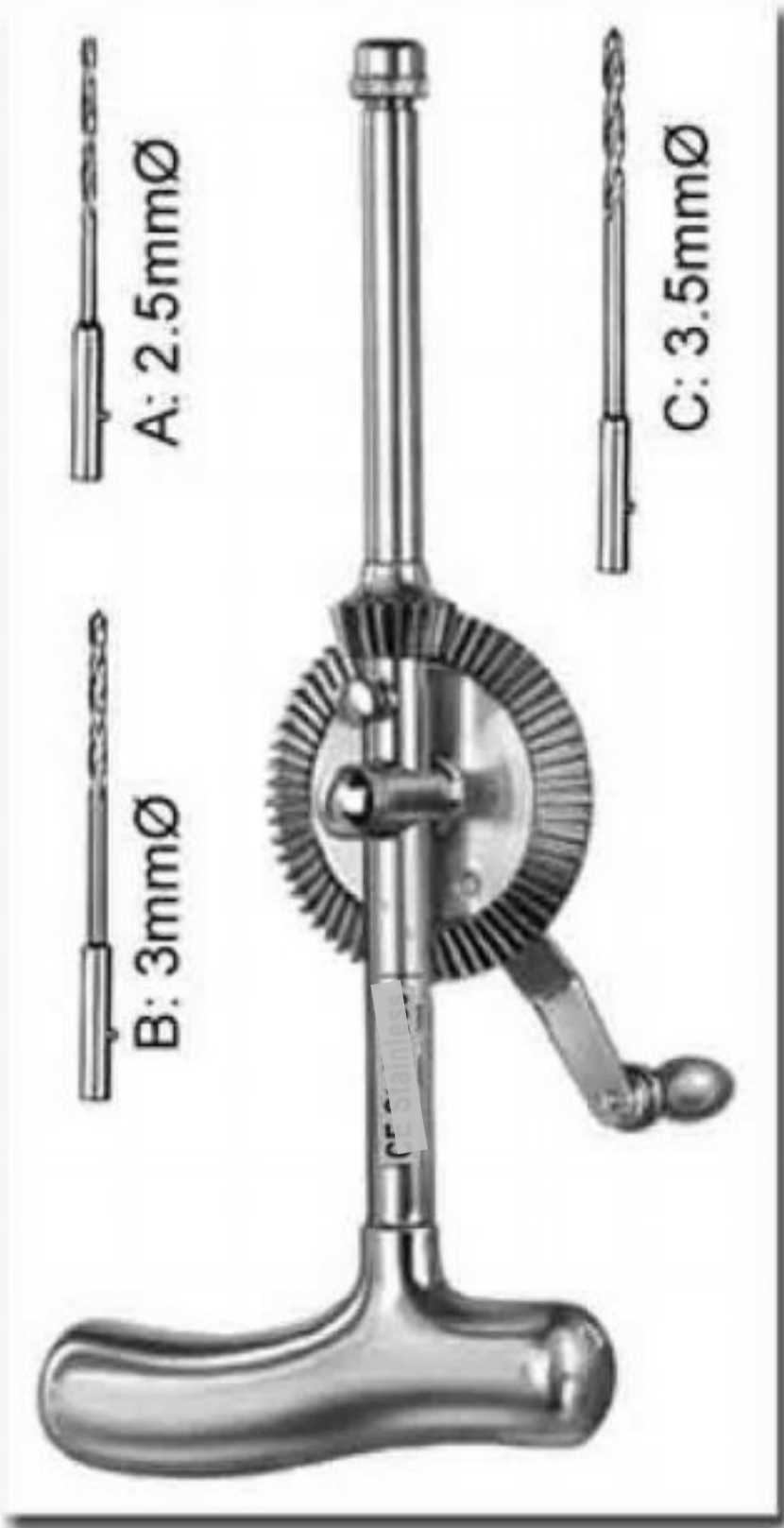

AJ-2087

Stille-Sherman Hand Drill
24 cm / 9 1/2"
with 3 twist drills



AJ-2088

Stille Hand Drill
20.5 cm / 8"
w/ 9 Twist Drills

Complete with Hand Drill art # 11-138-01

Fig.A: 2.5 mmØ Twist Drill

Fig.B: 3 mmØ Twist Drill

Fig.C: 3.5 mmØ Twist Drill

Fig.D: 4 mmØ Twist Drill

Fig.E: 10 mmØ Trephine

Fig.F: 5 mmØ Spherical Burr

Fig.G: 8 mmØ Spherical Burr

Fig.H: 12 mmØ Spherical Burr

Fig.I: 16 mmØ Spherical Burr

Fig.J: 1 mmØ Twist Drill

Fig.K: 1.5 mmØ Twist Drill

Fig.L: 2 mmØ Twist Drill

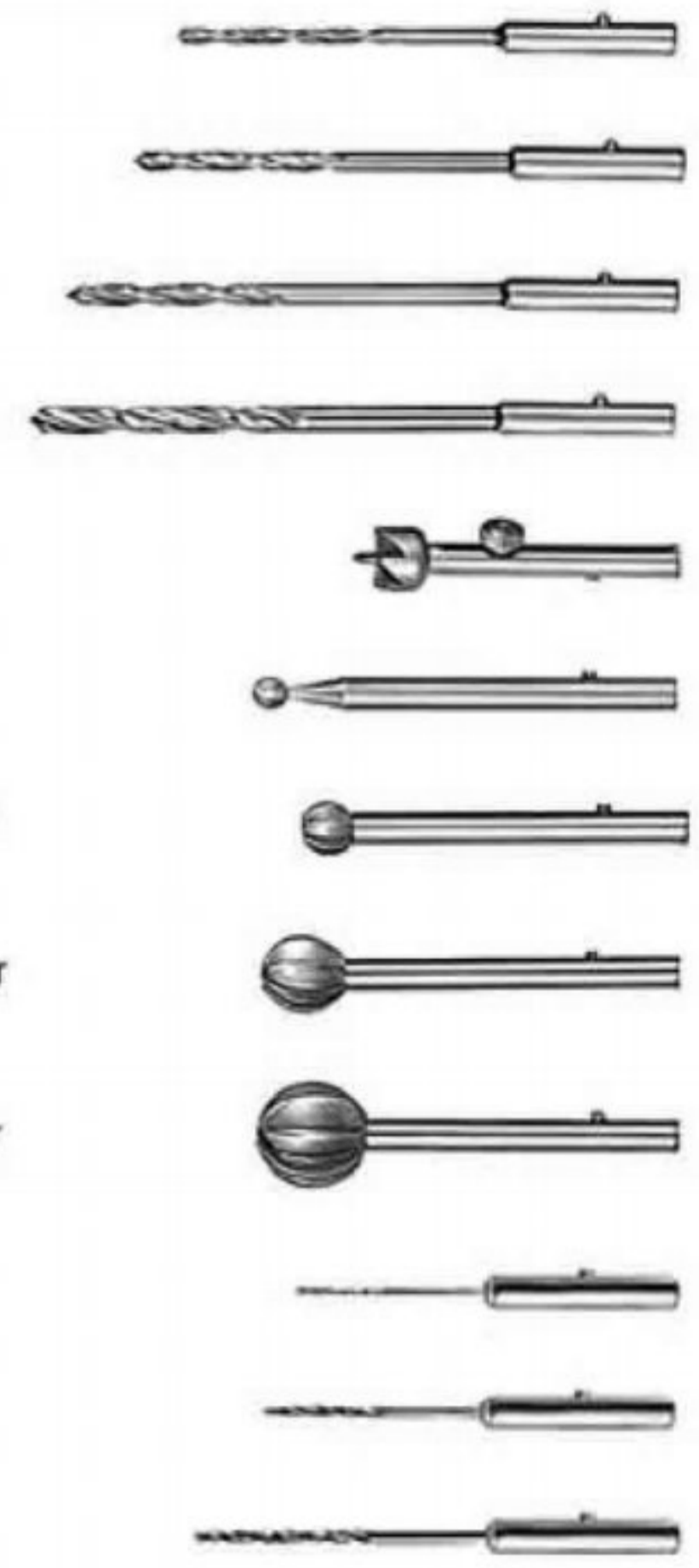

AJ-2089

Conical Burr Fig.1: 9 mmØ

Conical Burr Fig.2: 14 mmØ

Spherical Burr Fig.3: 16 mmØ

Spherical Burr Fig.4: 22 mmØ

Extension Piece Fig.9

AJ-2090
Hudson Hand Drill
28 cm / 11"
complete with burrs Fig #. 1 - 4
and extension piece # 9.
(art # 11-145-01 for more acc)

Flat Trephine Fig.5: 14 mmØ

Twist Drill Fig.6

Burr Fig.7

Burr Fig.7

AJ-2091
HUDSON (Drills)
Sold Separately

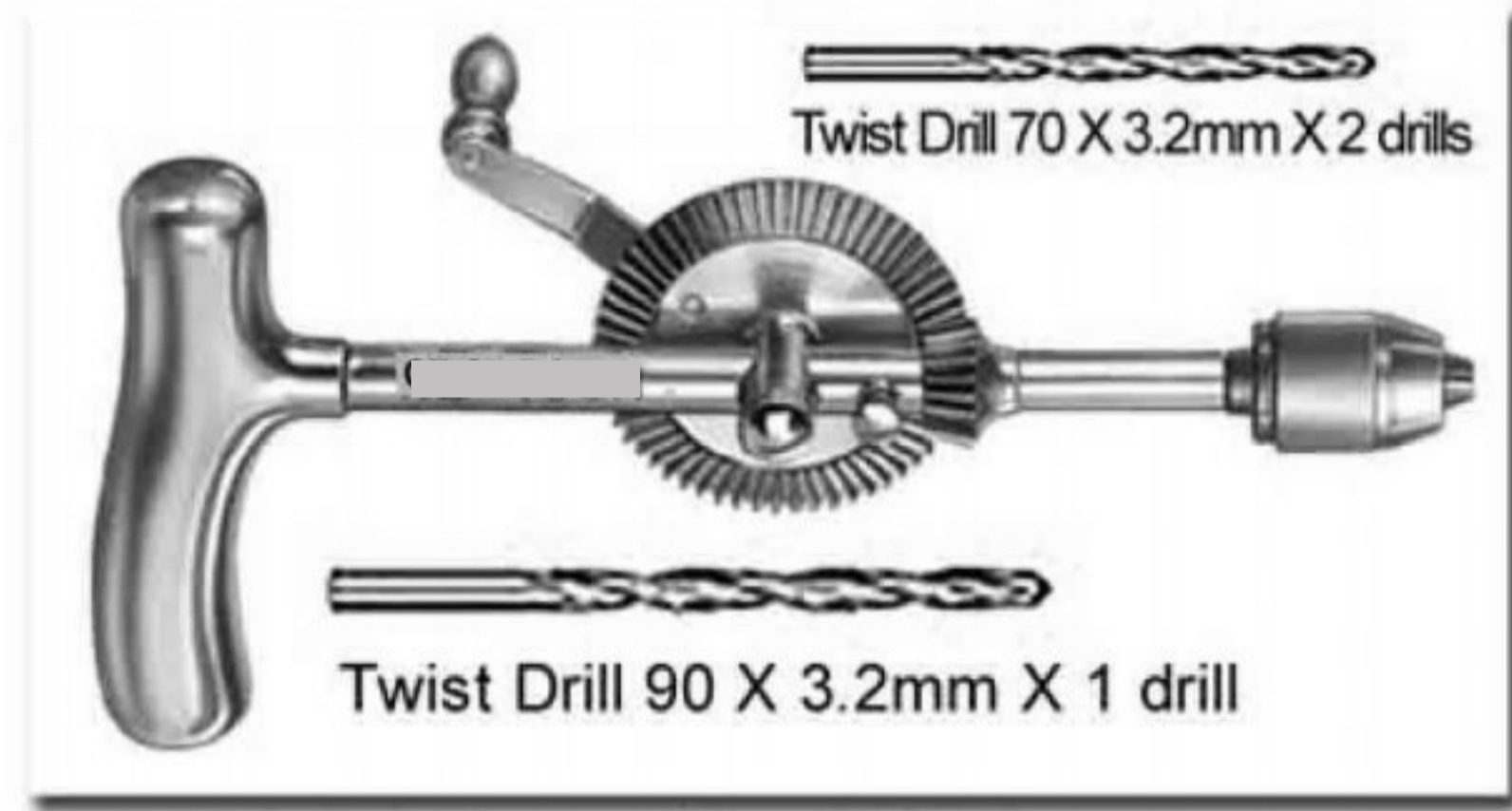

AJ-2092 **Moore Hand Drill**
complete with a set of 3 twist drills

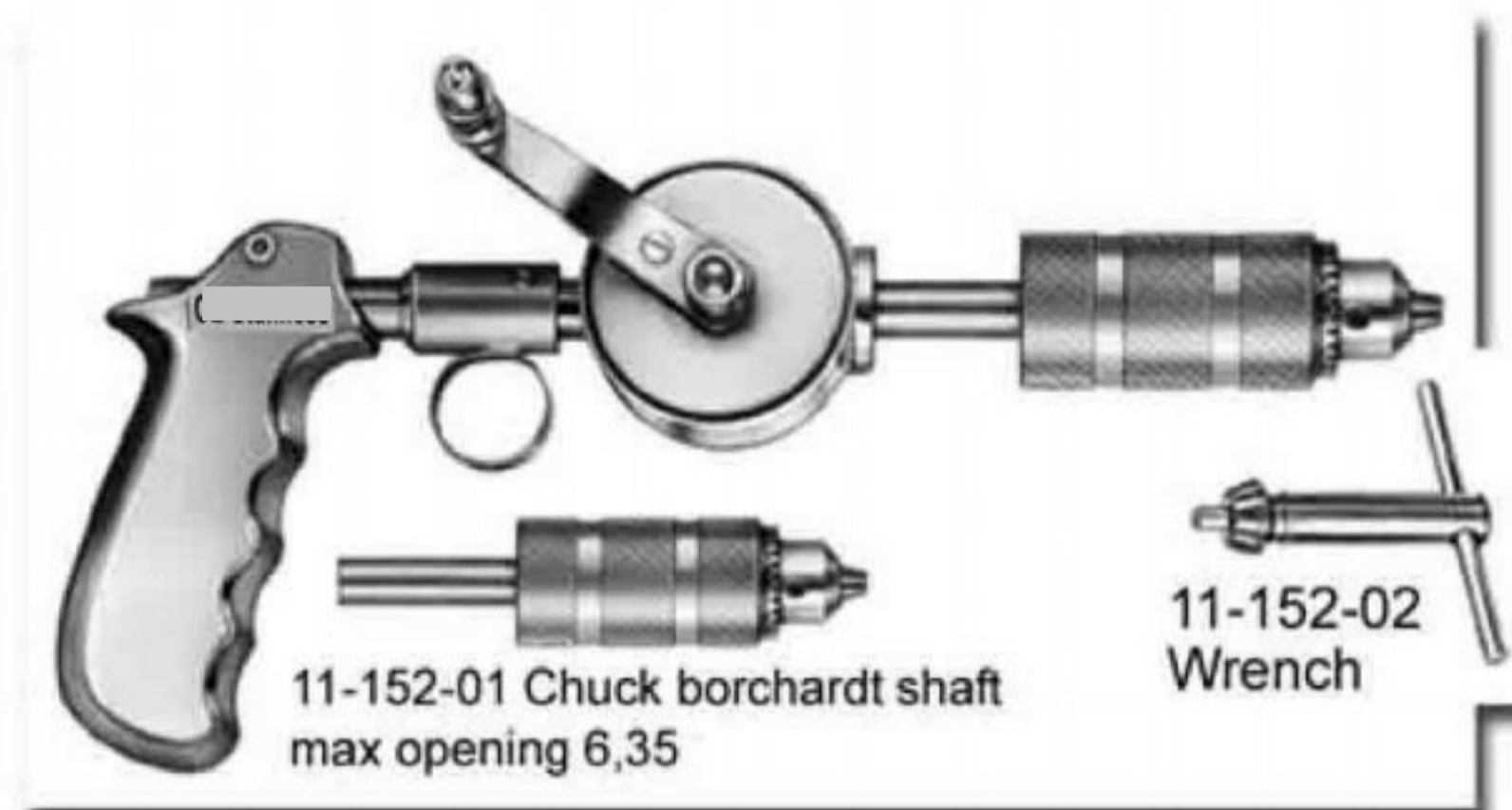

AJ-2093
Martin Hand Drill with Chuck & Wrench



AJ-2094
Bunnell Hand Drill
16cm,

Longitudinally Bored with 3-Jaw-Chuck
Light Metal Housing
opening up to 4mmØ



AJ-2095
Bunnell Type Hand Drill
16cm,

Twin Shade Powder Coated
Longitudinally bored with 3-Jaw-Chuck
light metal housing opening up to 4mmØ



AJ-2096
Ralk Hand Drill

Light Metal Housing
Literally Angled Handle with 3-Jaw-Chuck
and key, opening up to 6,35mmØ

HAND BONE DRILLS - KEYS



AJ-2097
Hand Drill
 All Covered
 Polished / Dull or Coated.
 Drills Holder at Bottom.



AJ-2098
Hand Drill
 All Covered
 Light Weight
 Polished / Dull or Coated.
 Key Holder and Self Retaining Locking Mechanism



AJ-2099
 Box for Hand Drills W/ Art #s: 11-450-00
 and 11-455-00 Outside Artificial Leather
 / Inside Jumbo Foam

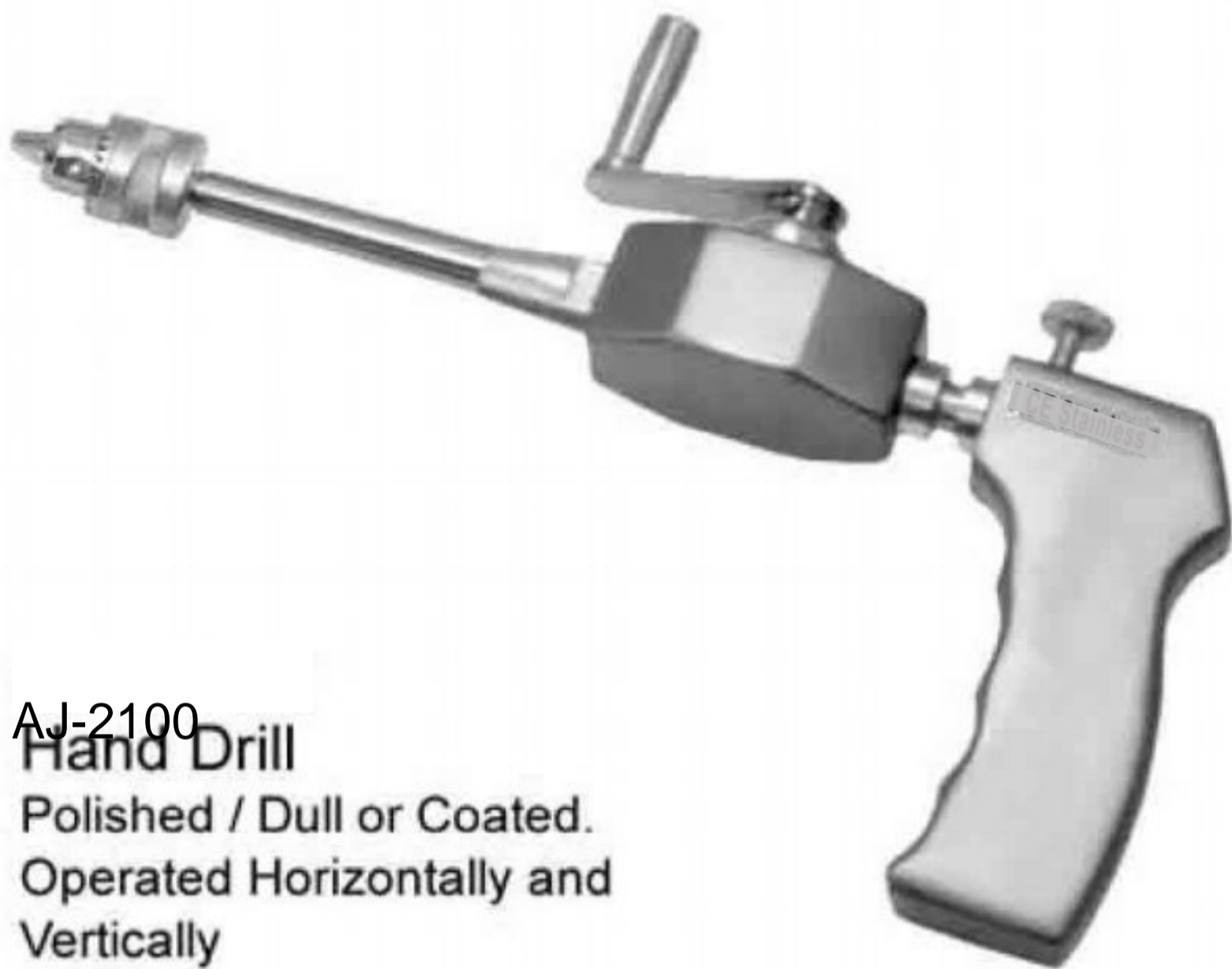

AJ-2100
Hand Drill
 Polished / Dull or Coated.
 Operated Horizontally and
 Vertically



Comes with Keys



AJ-2101
Hand Drill
 Polished / Dull or Coated.
 All Covered



AJ-2102
Hand Drill
 Polished / Dull
 or Coated.
 Open Housing



AJ-2103
Hand Drill
 Polished / Dull
 or Coated.
 Open Housing



AJ-2104
Hand Drill
 Polished / Dull
 or Coated.
 Semi Closed Housing



AJ-2104 Vickers Easidriver 14 cm / 5 1/2"



AJ-2105 14cm / 5 1/2"
 Handle W/ Chuck Longitudinally
 Bored Accomodating up to 3,95mm



AJ-2107
 Handle with chuck
 T-Shaped



AJ-2106
 Key

AJ-2108
 Key



AJ-2109
 Fibre T-Handle Key

DRILL BITTS - BURRS ETC



AJ-2110 5mm Borchardt Shaft Twist Drill
Long Working End

A: 2.0mm B: 2.5mm C: 3.0mm D: 3.2mm E: 3.5mm F: 4.0mm G: 5.0mm H: 6.0mm I: 7.0mm



AJ-2111 5mm Borchardt Shaft Twist Drill

A: 1.0mm B: 1.5mm C: 1.8mm D: 2.0mm E: 2.2mm F: 2.5mm G: 2.8mm H: 3.0mm I: 3.2mm J: 3.5mm K: 4.0mm L: 5.0mm



AJ-2112 5mm Borchardt Shaft Flat Trepine

A: 1.8mm B: 2.0mm C: 2.2mm D: 2.5mm E: 3.0mm F: 3.5mm G: 4.0mm H: 5.0mm



AJ-2113 5mm Borchardt Shaft Spherical Burr
A: 3.0mm B: 4.0mm



AJ-2114 5mm Borchardt Shaft Spherical Burr
A: 3.0mm B: 5.0mm

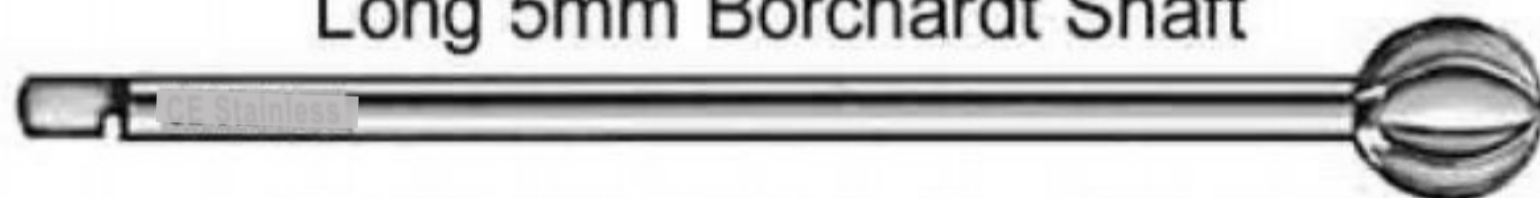

Long 5mm Borchardt Shaft

AJ-2115 Doyen Spherical Burr

A:4mm B:6mm C:8mm D:10mm E:12mm F:14mm G:16mm

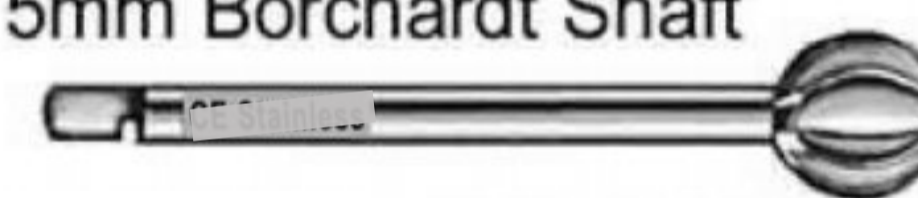

Short 5mm Borchardt Shaft

AJ-2116 Doyen Spherical Burr

A:4mm B:6mm C:8mm D:10mm E:12mm F:14mm G:16mm



AJ-2117 Doyen Conical Burr
Coarse Spacing 12mm Dia



AJ-2118 Doyen Conical Burr
Fine Spacing A:8mm / B:10mm



AJ-2119 Doyen Cylindrical Burr
Coarse Spacing A:12mm / B:15mm



AJ-2120 Albee Burr Oval
Coarse Spacing A:8mm / B:10mm / C:12mm



AJ-2121 Albee Burr Pointed
7mm

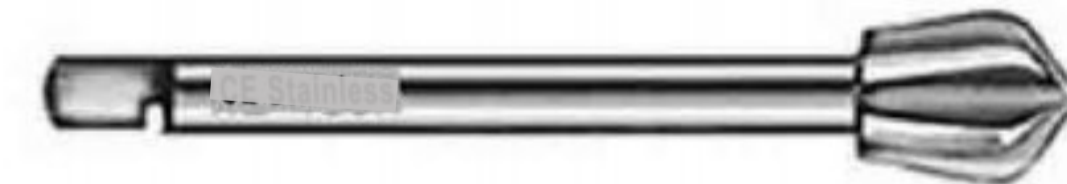

AJ-2122 Borchardt Burr Oval
Coarse Spacing 13mm



AJ-2123 Flat Burr
Short Borchardt Shaft 25mm



AJ-2124 Toti Trepine
Short Borchardt Shaft 8mm

BONE HOLDING CLAMPS



AJ-2125
Standard

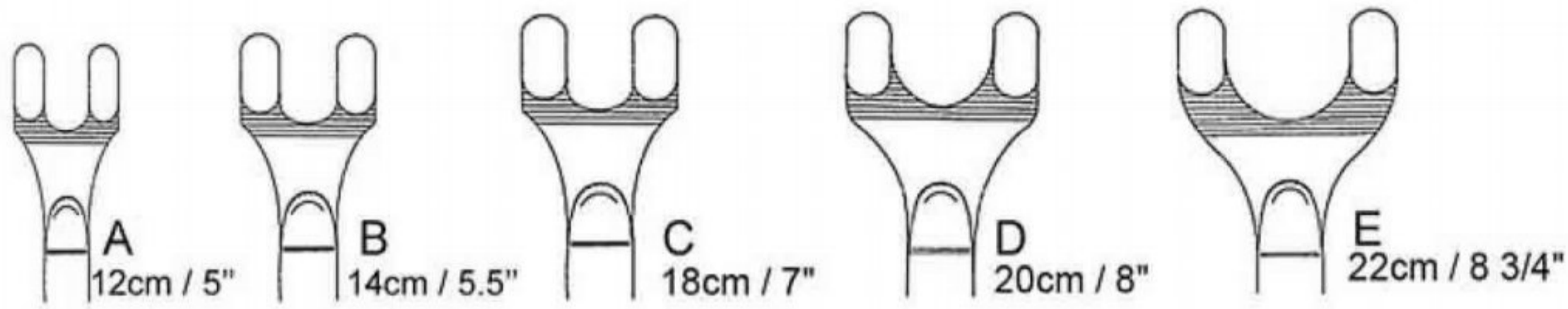

Gerster-Lowman Bone Holding Clamp



AJ-2127

Gerster Traction Bar
15cm / 6"

AJ-2126
Angled

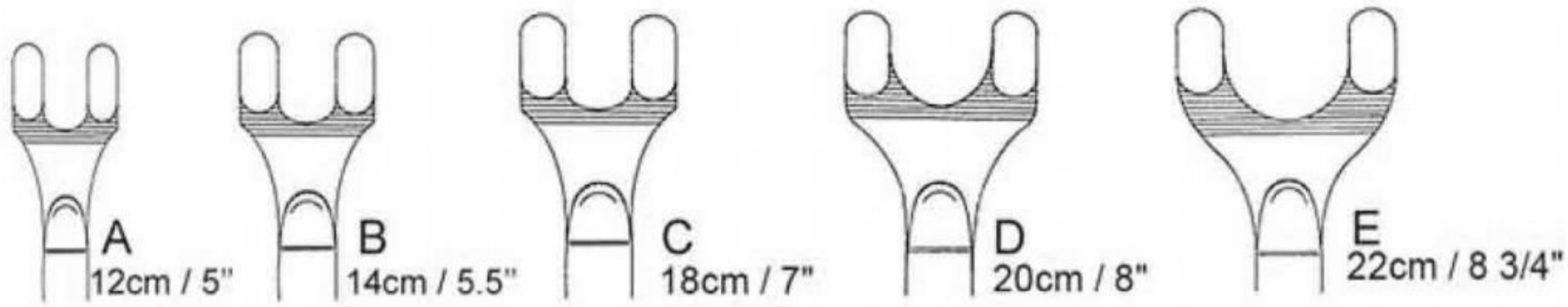
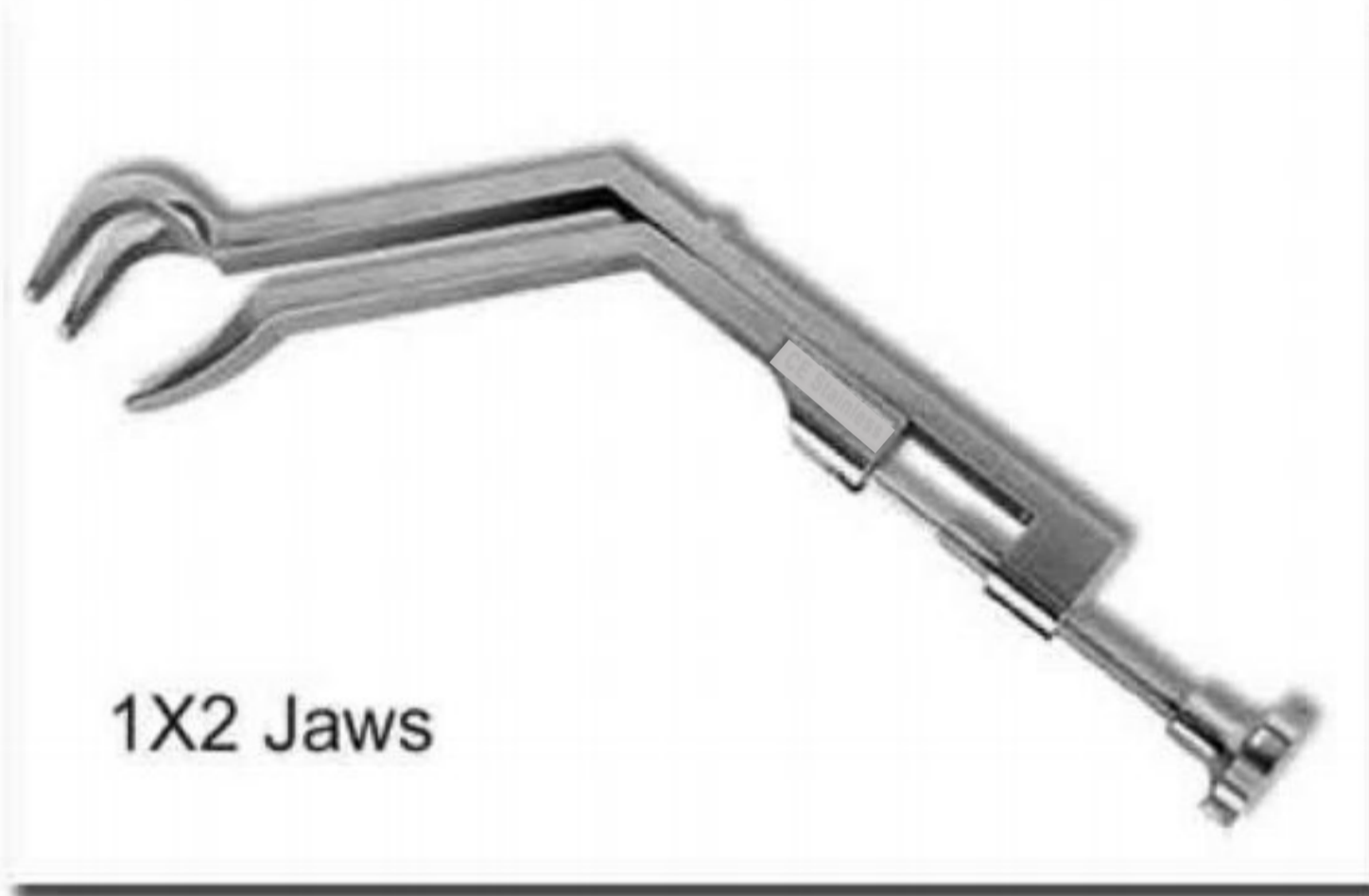

Gerster-Lowman Bone Holding Clamp

1X1 Jaws

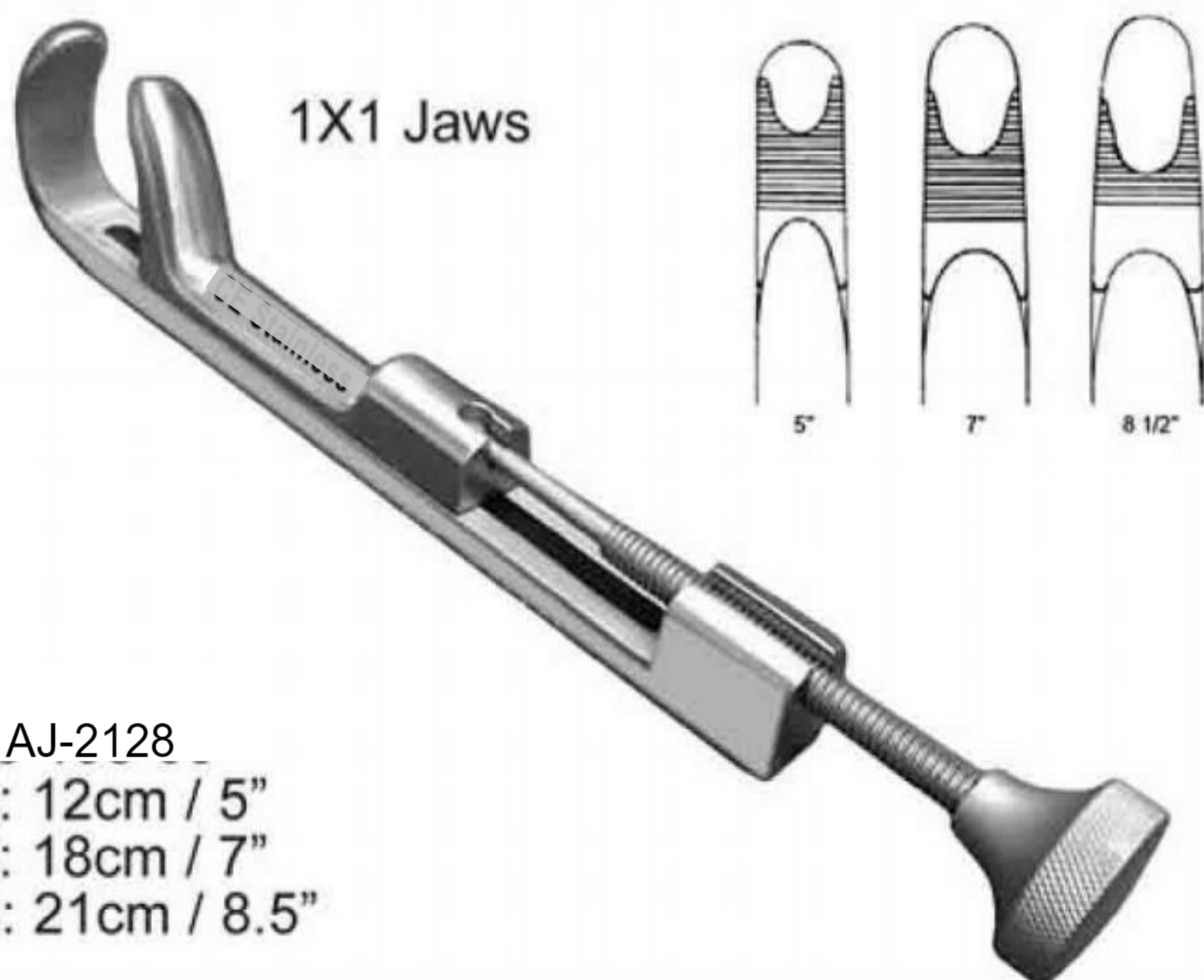

AJ-2128
A: 12cm / 5"
B: 18cm / 7"
C: 21cm / 8.5"

Gerster-Lowman Bone Holding Clamp

2X2 Jaws

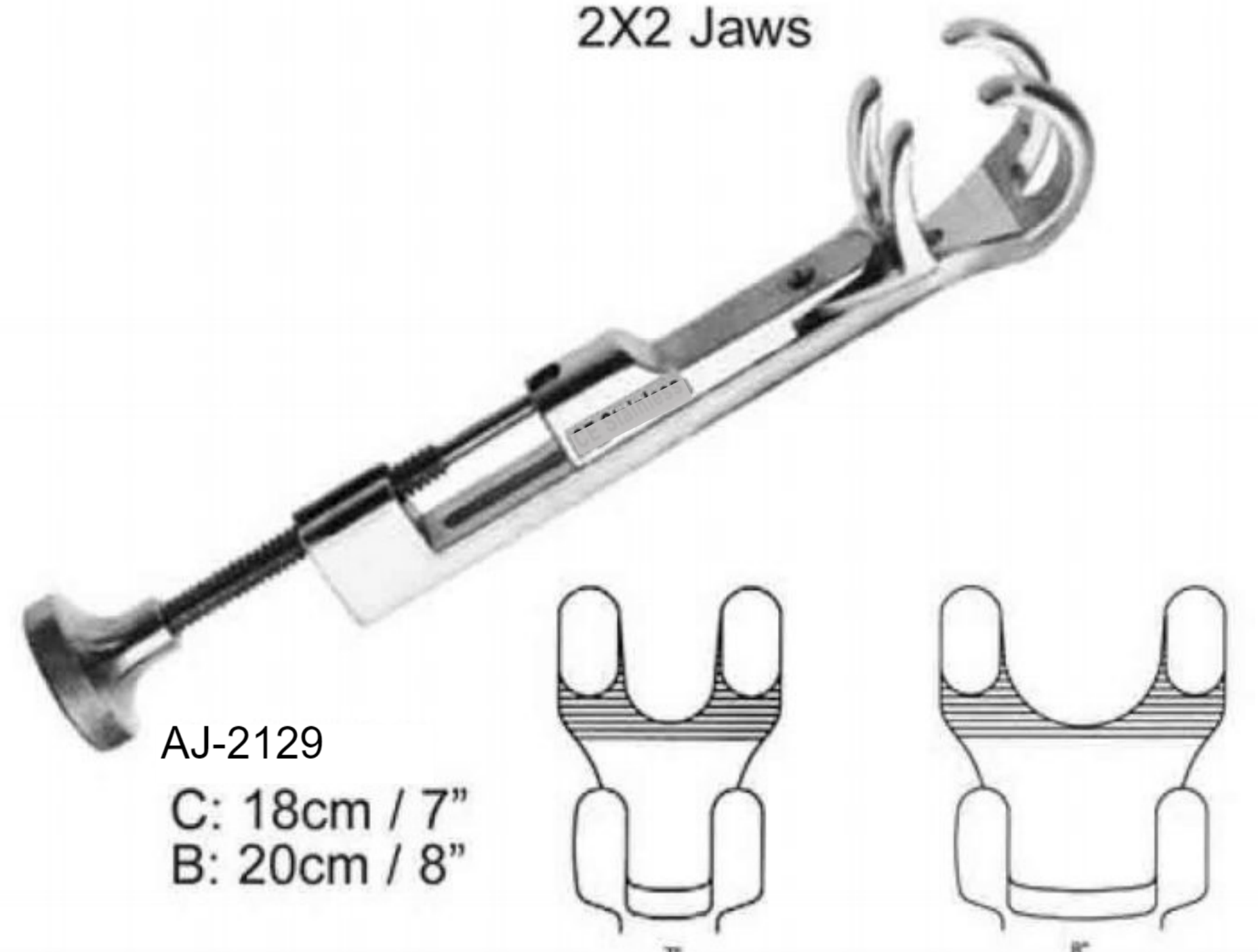

AJ-2129
C: 18cm / 7"
B: 20cm / 8"

Gerster-Lowman Bone Holding Clamp

WISE GRIPS - PARALLEL GRIP PLIERS ETC



AJ-2130 Flat Nose Plier
18.5 cm / 7 1/4" Parallel Grip SS



AJ-2132 at Nose Plier / Cutter
18.5 cm / 7 1/4" Parallel Grip

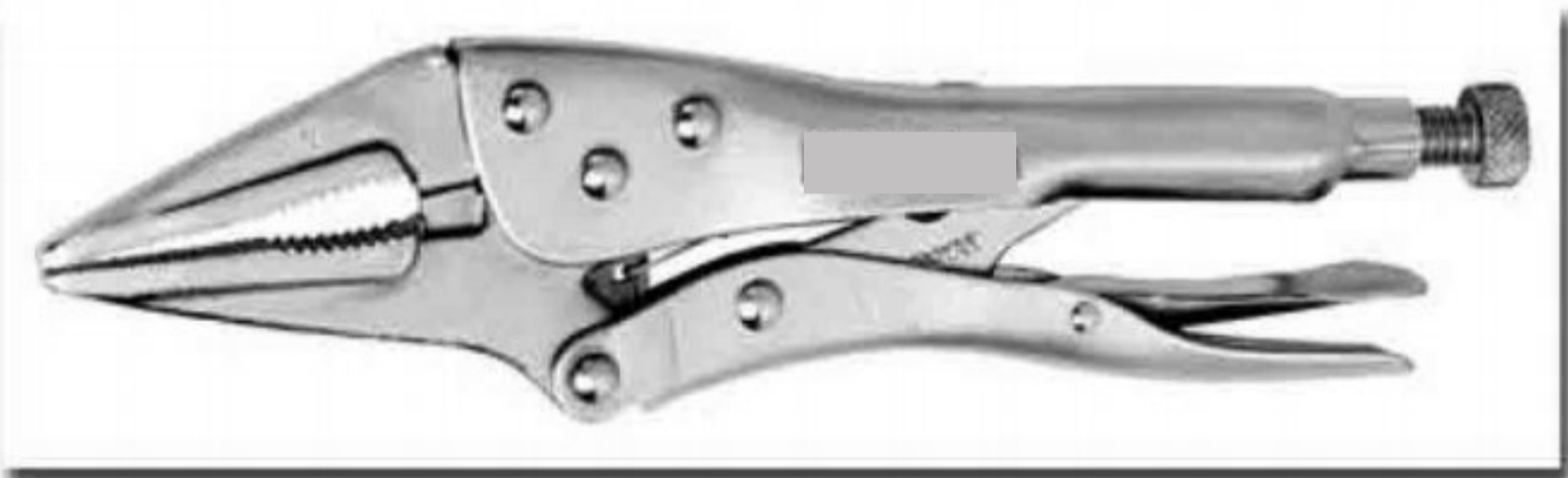

AJ-2134 Long Nose Plier / 22 cm / 8 1/4"



AJ-2136
Vise Grip 20.5 cm / 8"
Stainless Steel

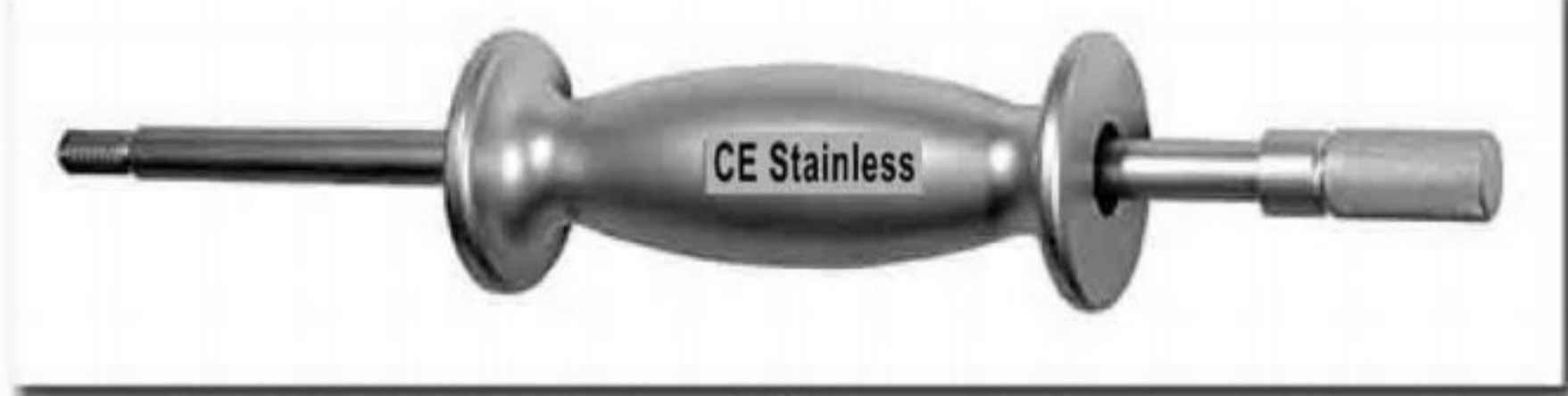

SLAP HAMMER w/ Threaded Shaft Head
to be used with AJ-2140 and AJ-2140

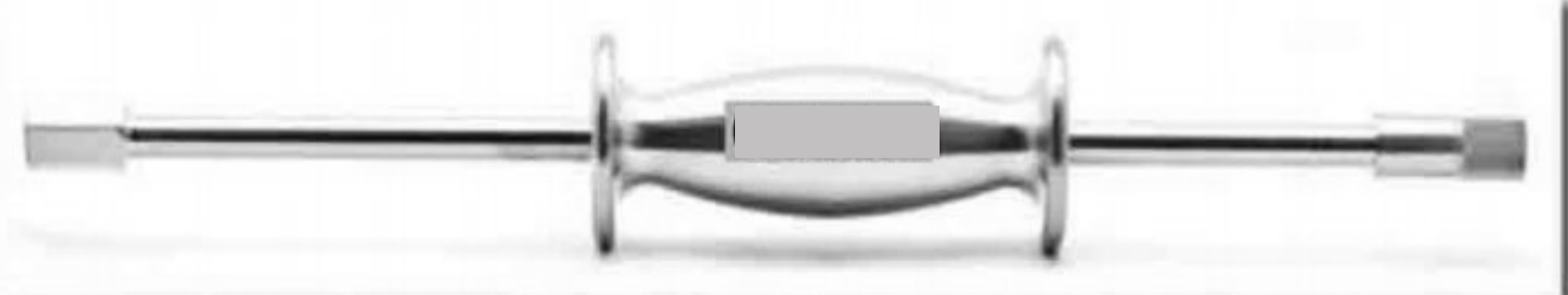

SLAP HAMMER w/ Hexa Shaft Head
to be used with AJ-2141 and AJ-2142



AJ-2143 Regular Jaw Locking Plier
A: 18 cm / 7" B: 20 cm / 8"
C: 23 cm / 9"



AJ-2131
Vise Grip 23 cm / 9"
Locking Plier



AJ-2133
Vise Grip 20.5 cm / 8"
Locking Plier

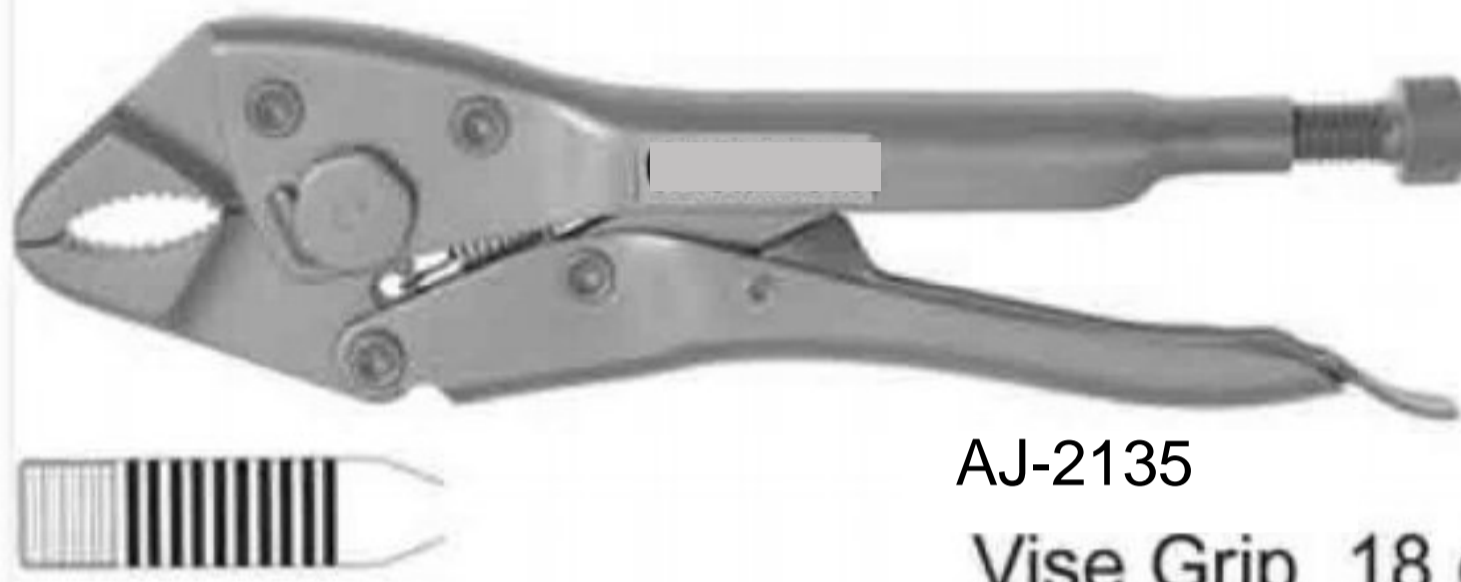

AJ-2135
Vise Grip 18 cm / 7"
Locking Plier



AJ-2137
Needle Nose Locking Plier
30 cm / 12"

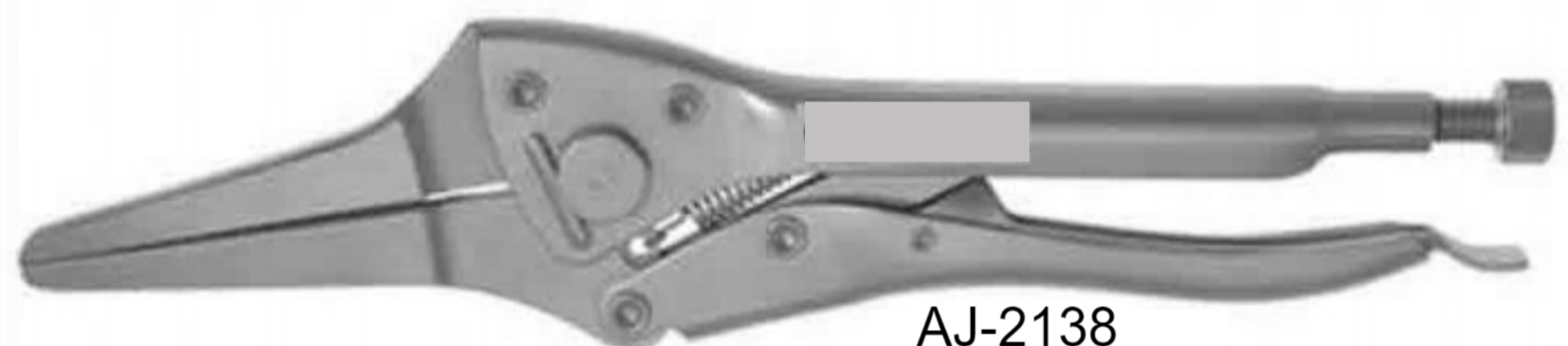

AJ-2138
Needle Nose Locking Plier
25.5 cm / 10"

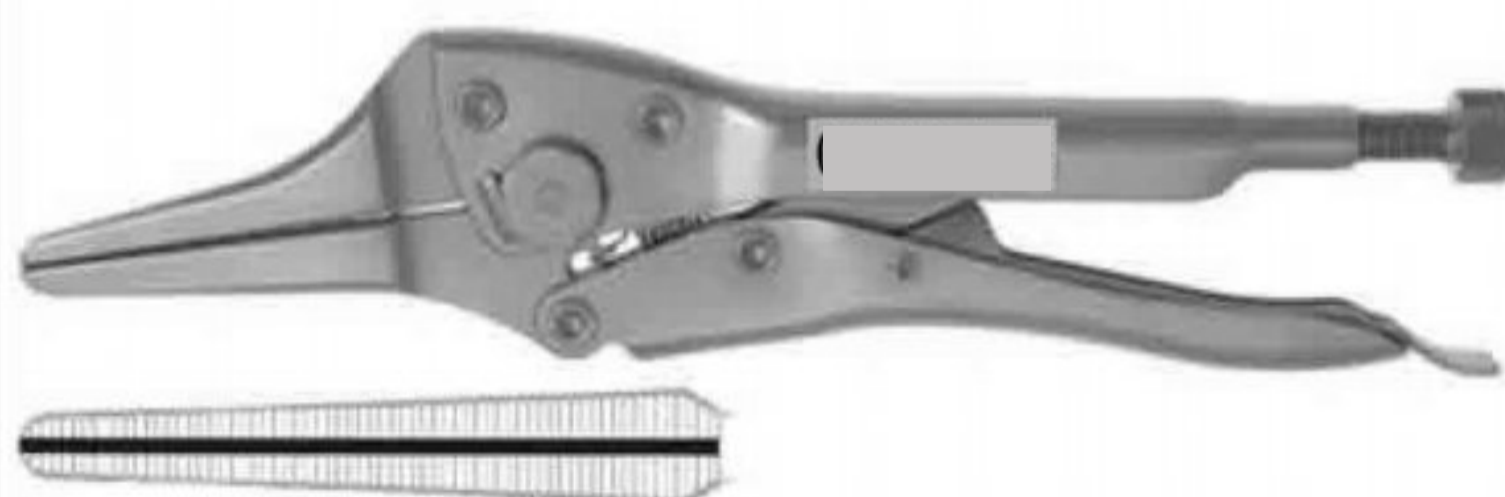

AJ-2139
Needle Nose Locking Plier
22 cm / 8.5"



AJ-2144
Needle Nose Locking Plier
A: 22 cm / 8.5"
B: 25.5 cm / 10"
C: 30 cm / 12"

BENDING - WIRE CUTTING PLIERS



AJ-2145
Combi-Flat Nose Pliers 15 cm / 6"
for Bending & Cutting

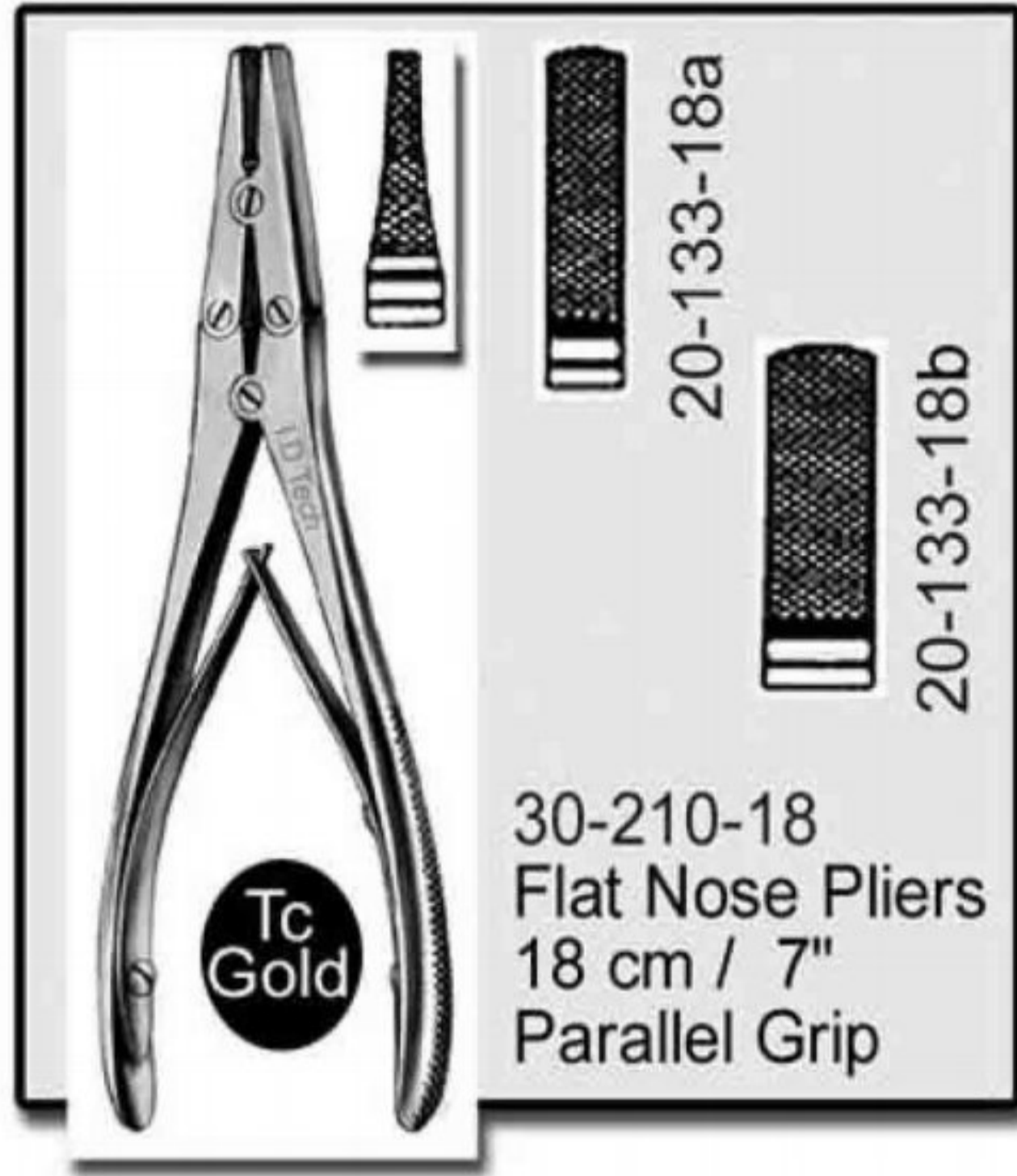

AJ-2146
Round / Flat Nose Pliers
18 cm / 7"

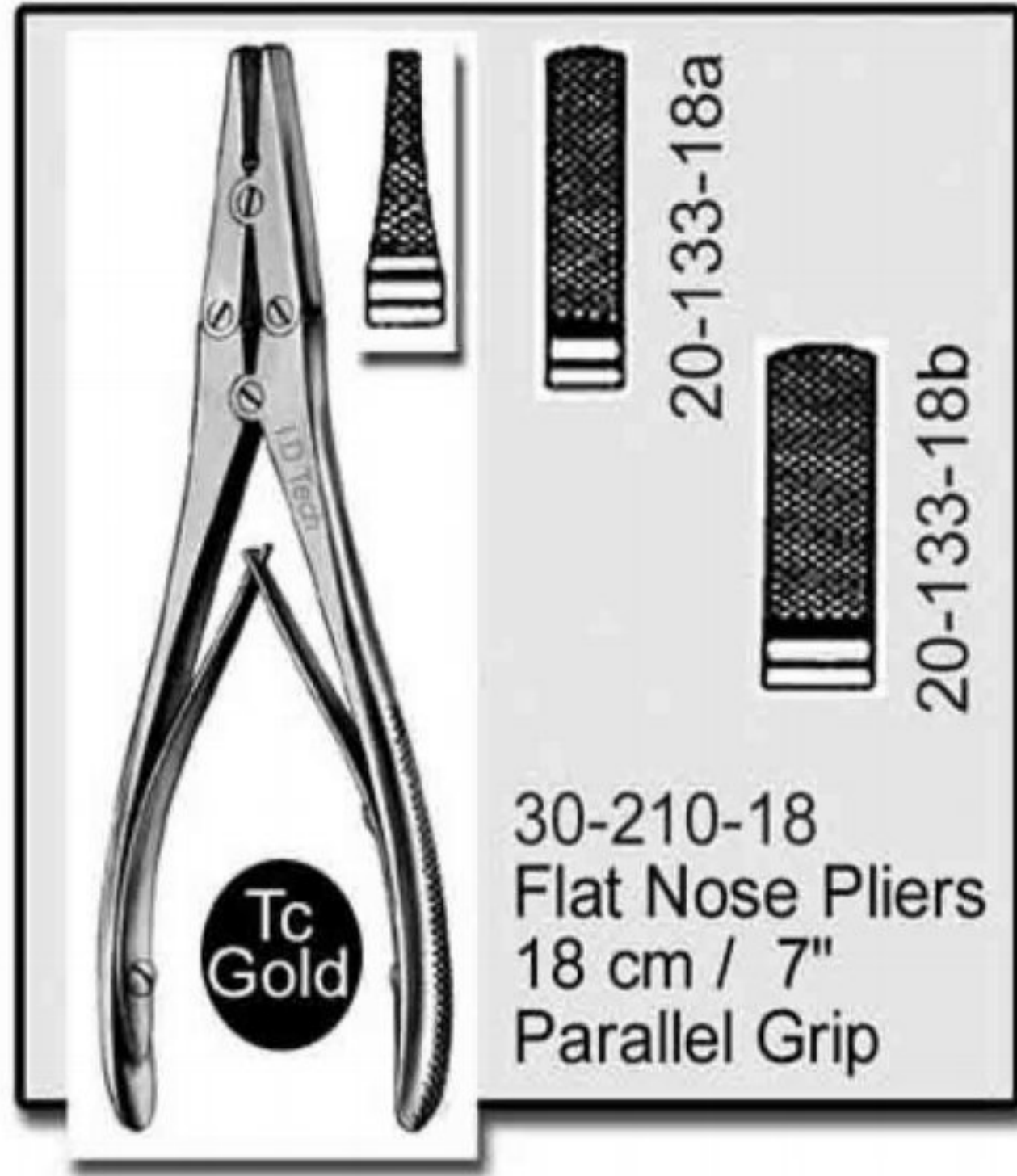

AJ-2147
Flat Nose Pliers
17 cm / 6 3/4" with crosswise groove

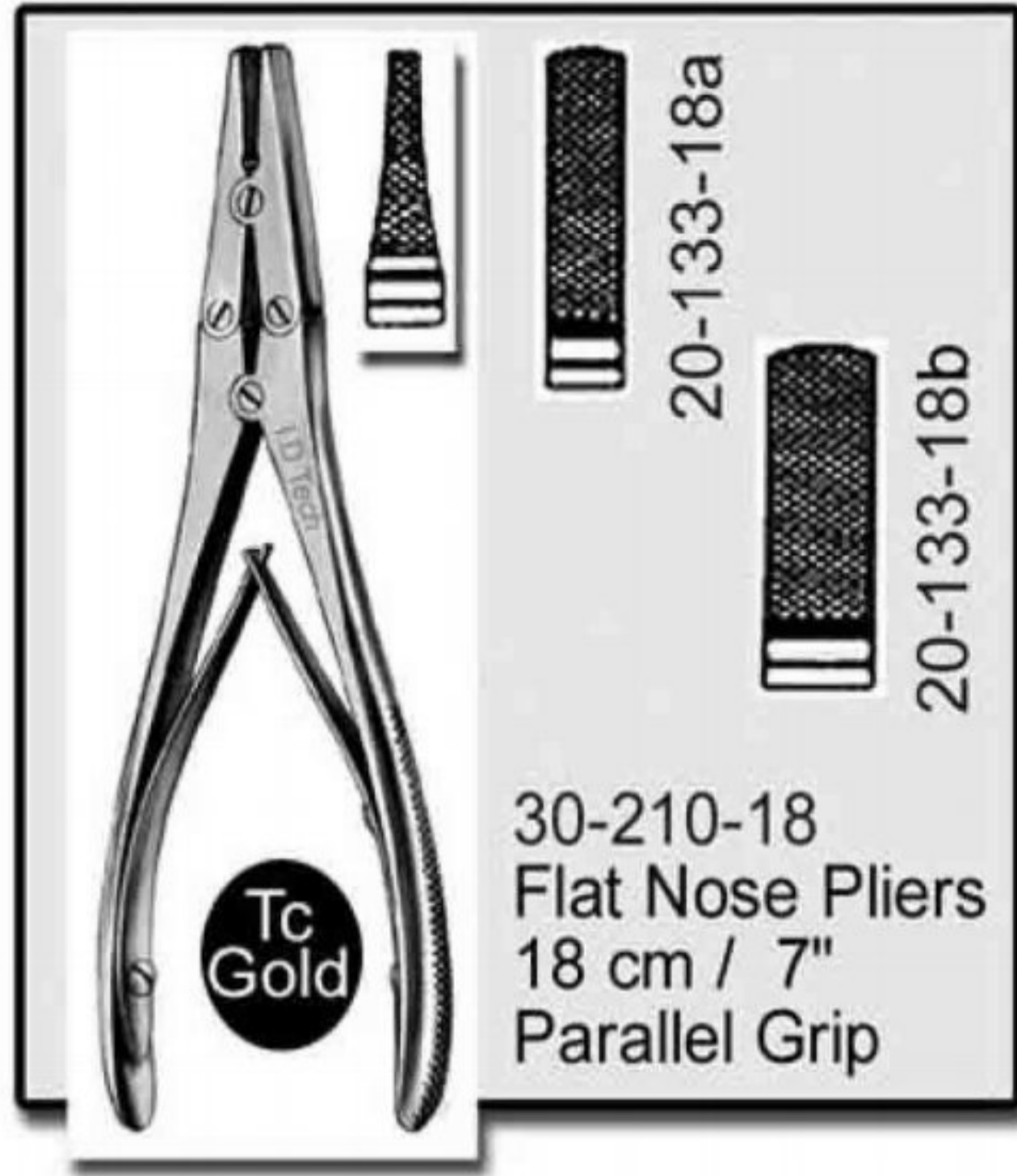

AJ-2150
Flat Nose Pliers
13.5 cm / 5 1/4"

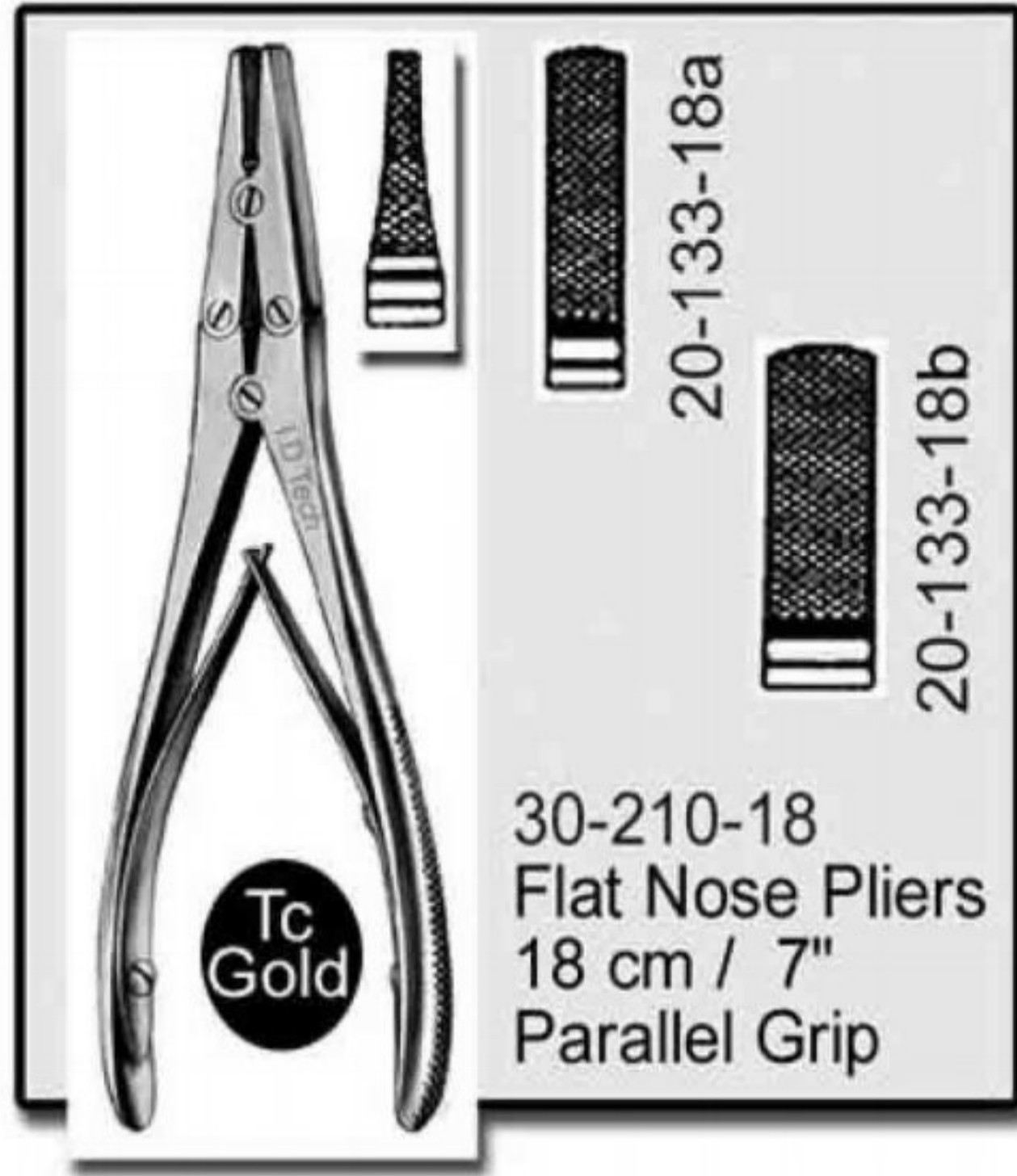

AJ-2151
Hackstock Flat
Nose Pliers 16cm / 6 1/4"
with longitudinal groove

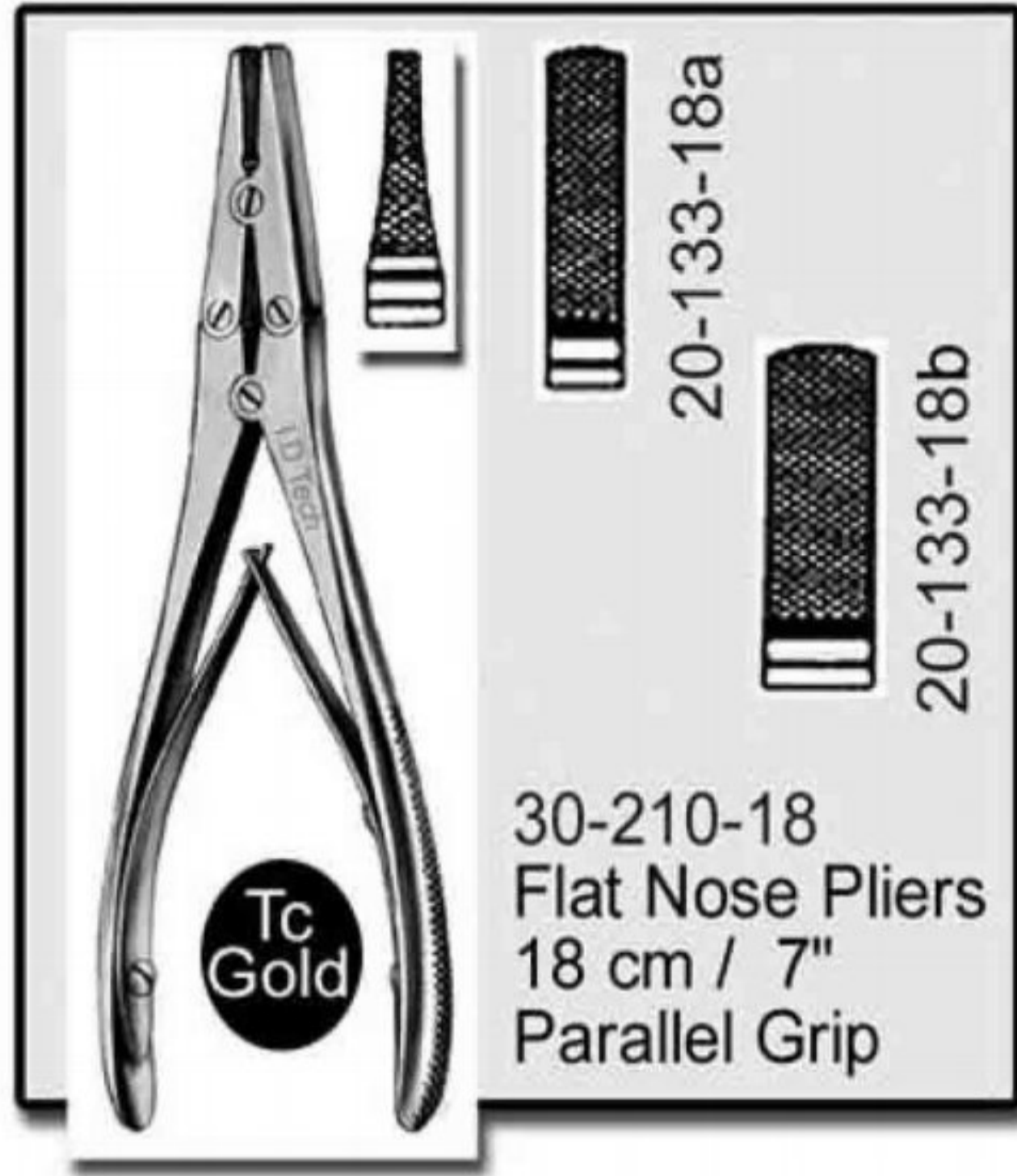

AJ-2152
Flat Nose Pliers
17.5 cm / 7"

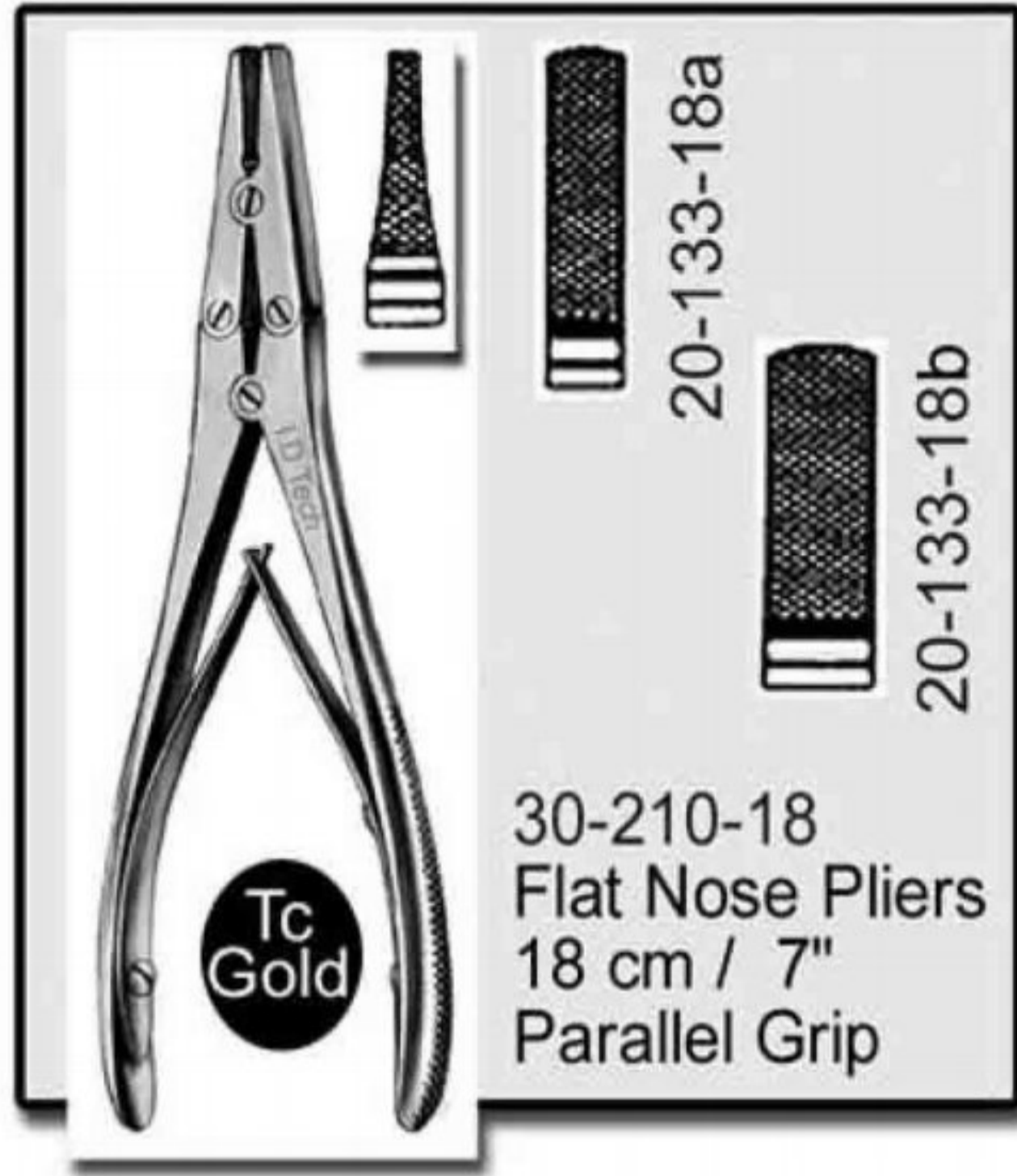

AJ-2153
Flat Nose Pliers Pointed
19.5 cm / 7 3/4"



AJ-2154
Platypus Nail
Pulling Forceps
15.5 cm / 6 1/4"

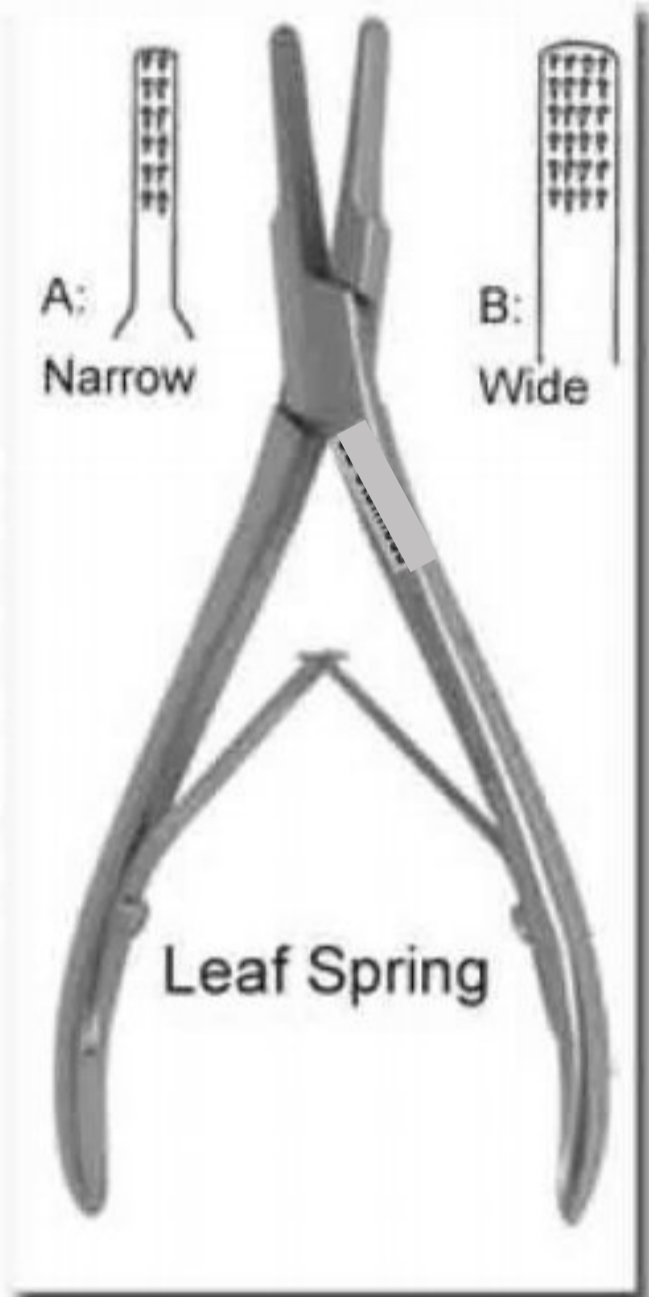

AJ-2155
Platypus Nail
Pulling Forceps
15.5 cm / 6 1/4"



AJ-2156
Round Nose Pliers
15.5 cm / 6 1/4"



AJ-2157
Needle Nose Pliers
15.5 cm / 6 1/4"

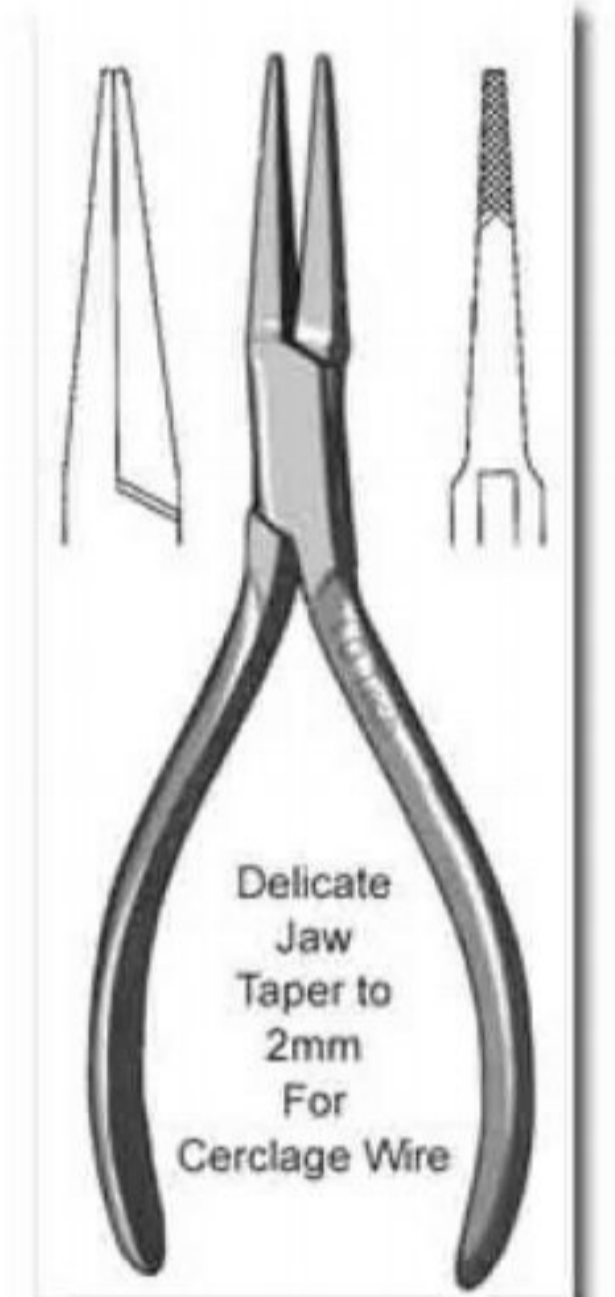

AJ-2158
Flat Nose Pliers
15 cm / 6"

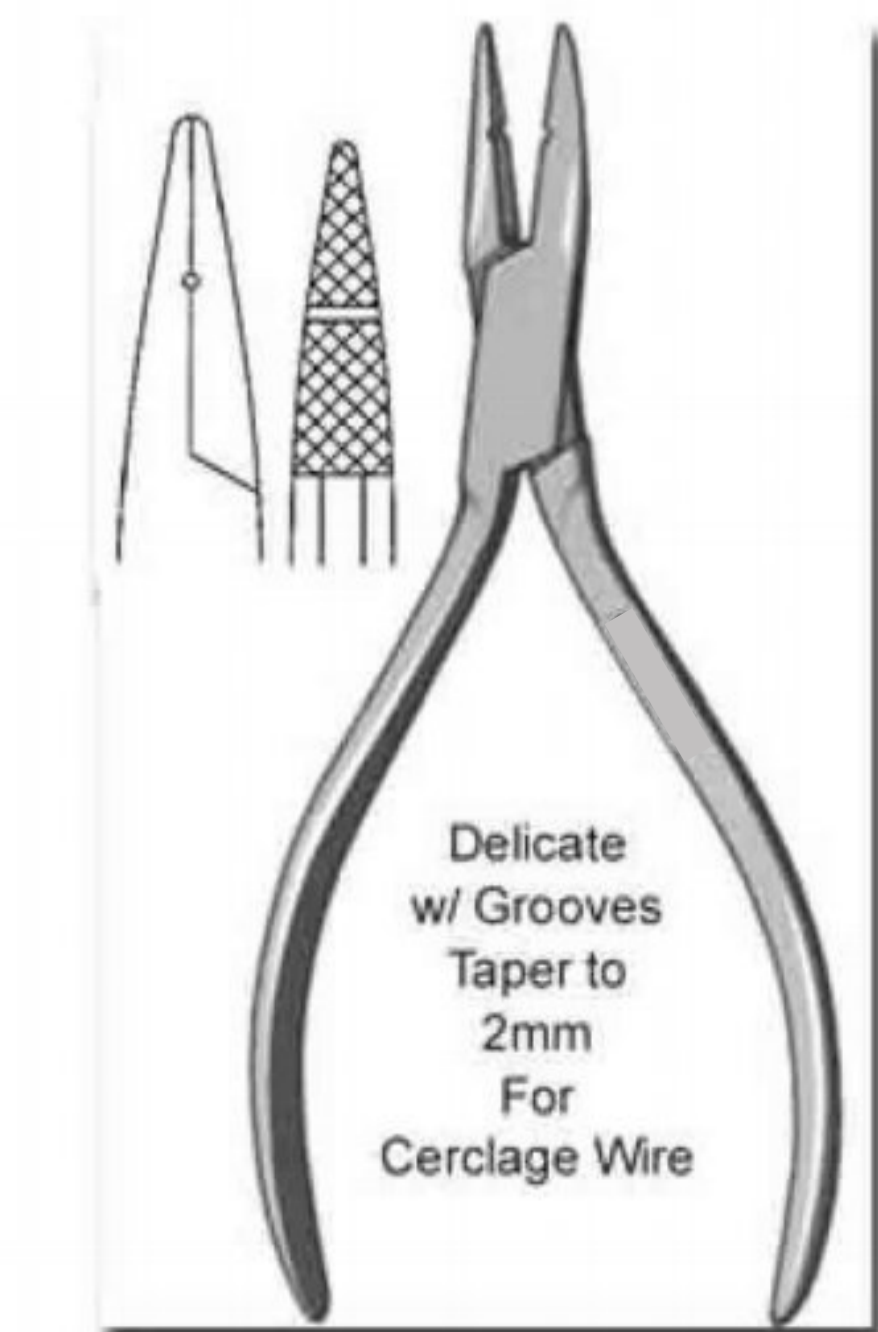

AJ-2159
Needle Nose Pliers
13.5 cm / 5 1/4"

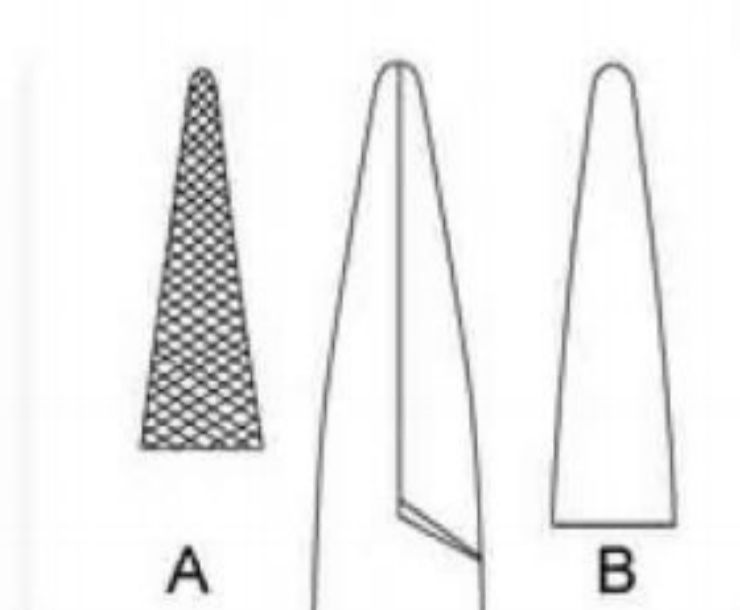

AJ-2160
Needle Nose Pliers
Taper to 2mm Tip
14 cm / 5 1/2"
A: Fine Cross Serration
B: Smooth



AJ-2161
18.5 cm / 7 1/4"
Wire Cutting Pliers
Hard wires up to 1.8mm Ø



AJ-2162
Martin "Diamant"
Hard wires up to 1.5mm Ø

BENDING - WIRE CUTTING PLIERS



AJ-2163
14 cm / 5 1/2"
Circlage Pliers / Cutter

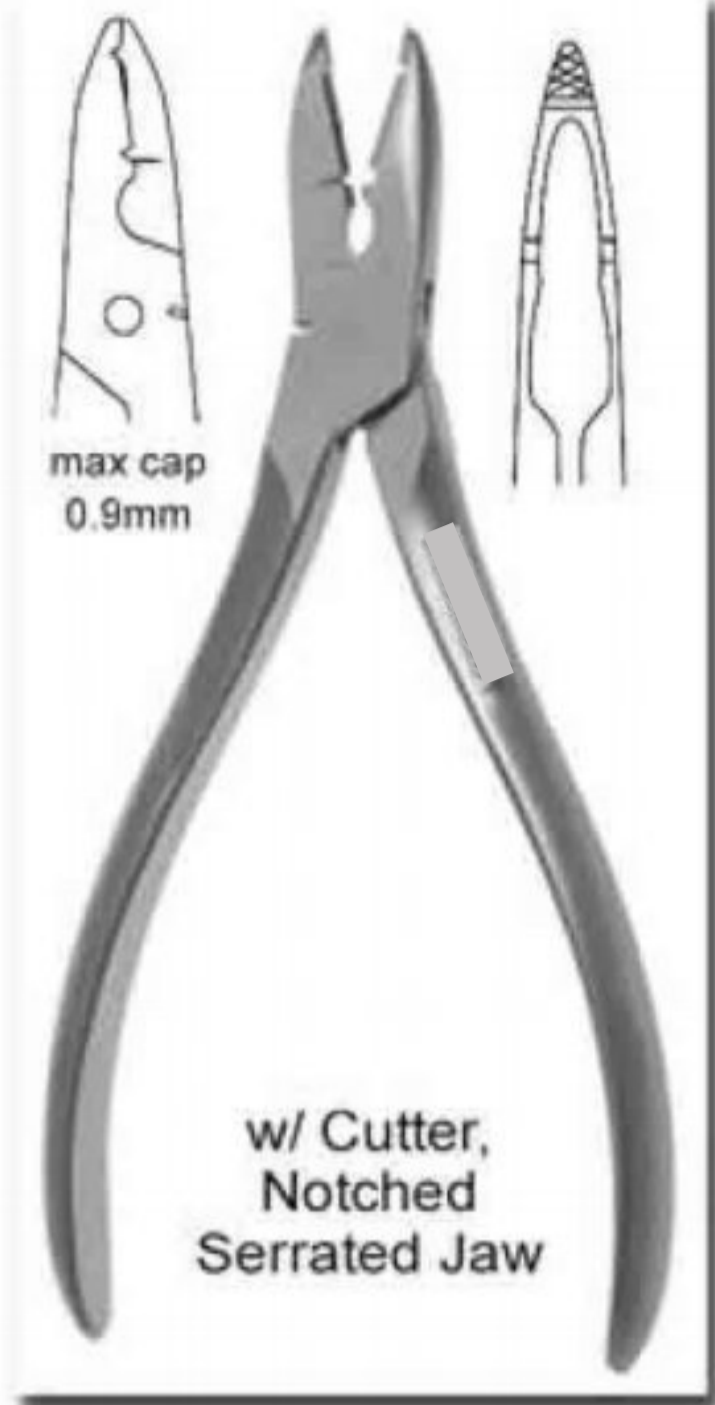

AJ-2164
20 cm / 8"
Wire Bending Pliers

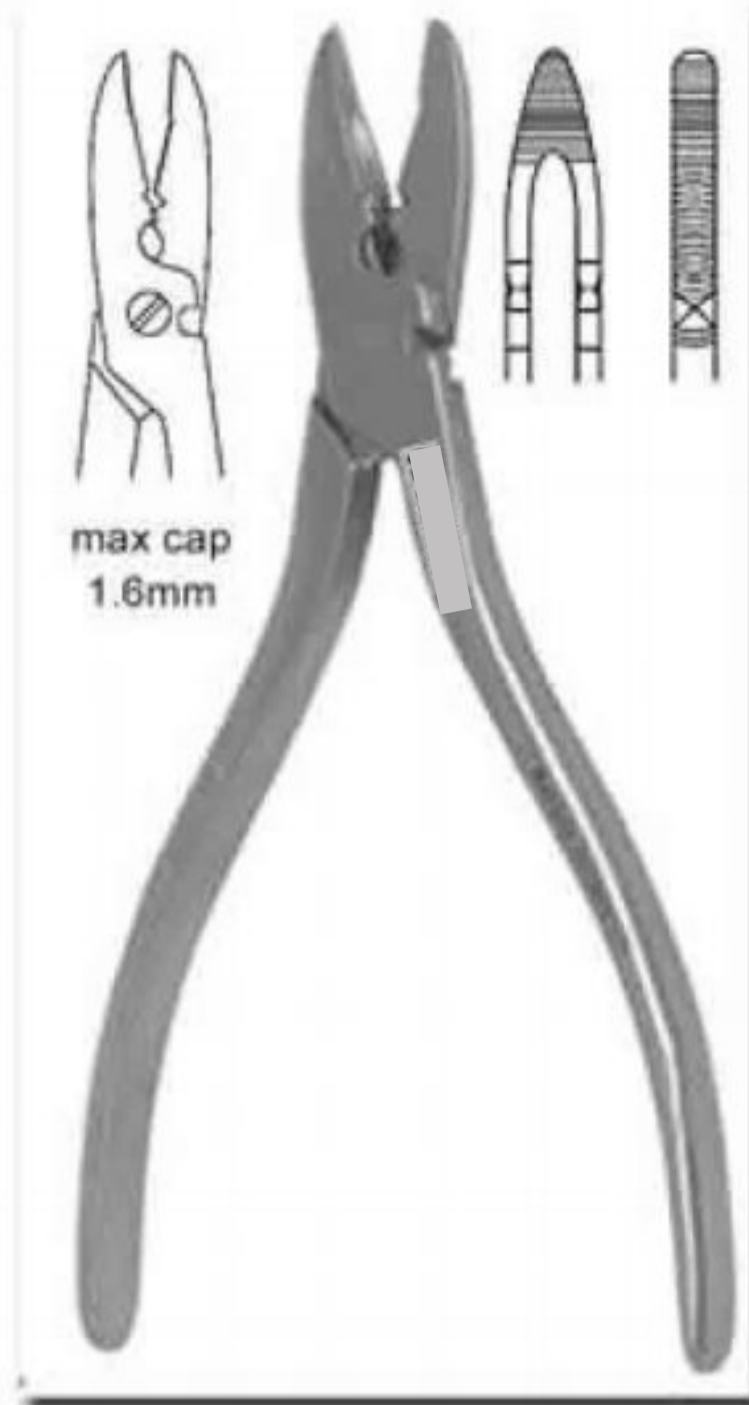

AJ-2165
15 cm / 6"
Wire Bending Pliers

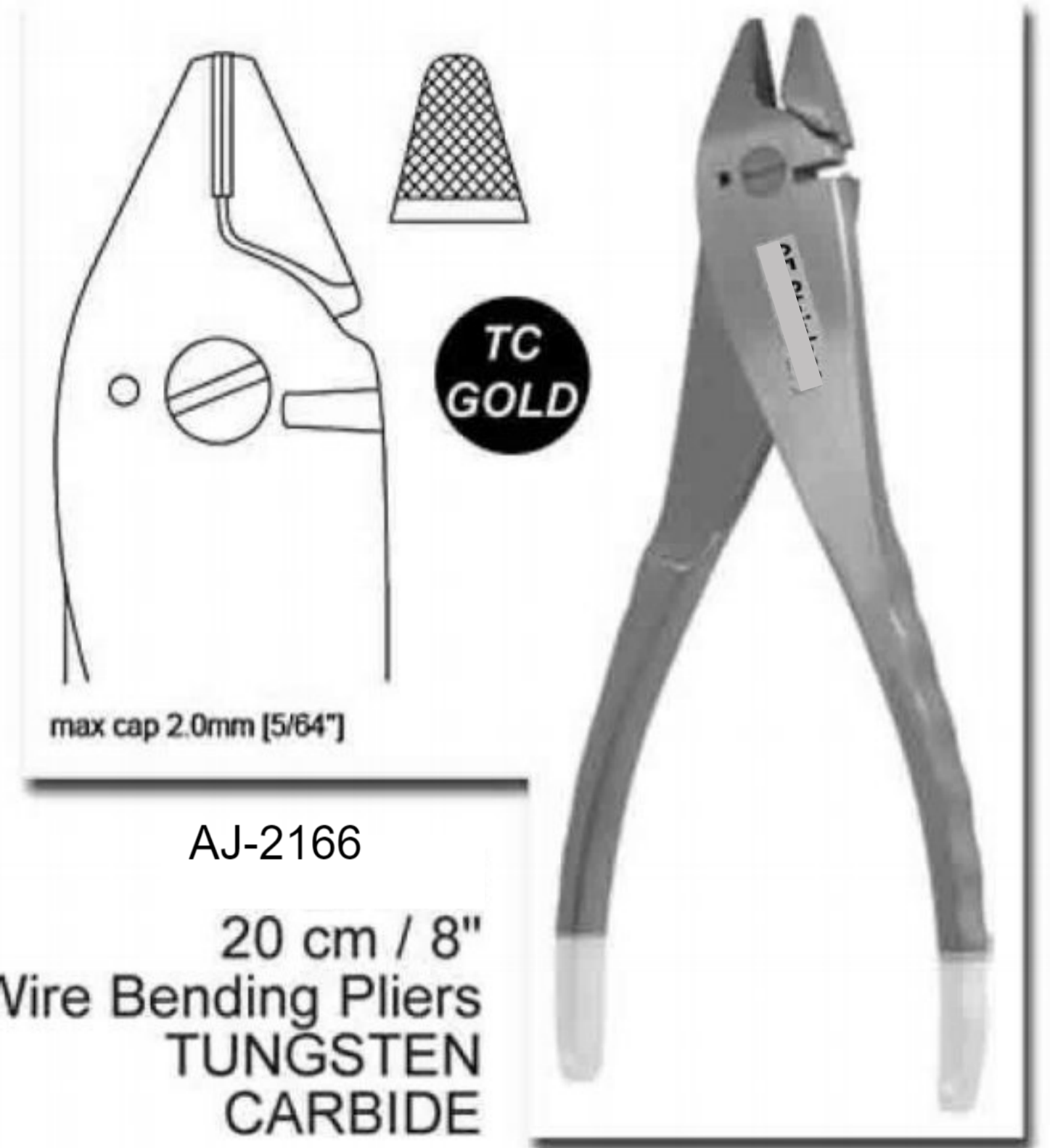

AJ-2166
20 cm / 8"
Wire Bending Pliers
TUNGSTEN
CARBIDE



AJ-2167
15 cm / 6"
Needle Nose Pliers

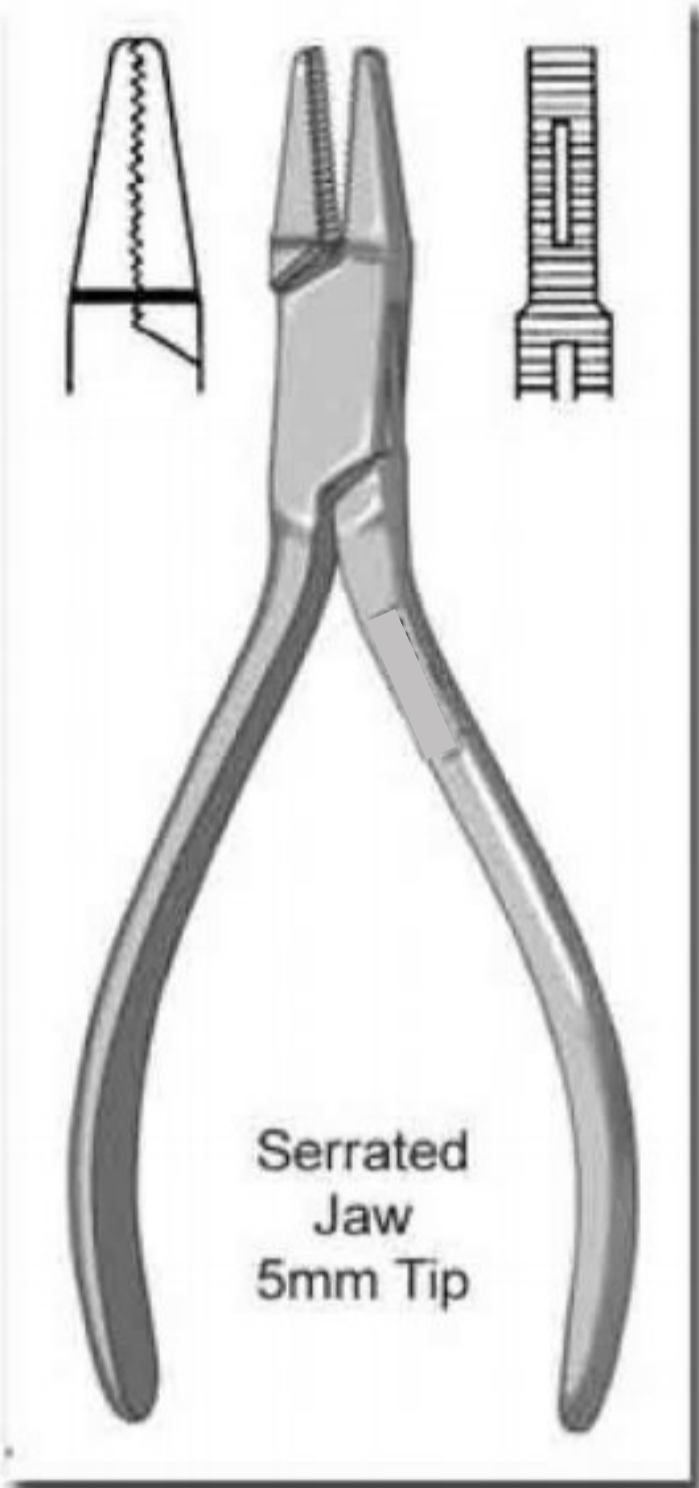

AJ-2168
14 cm / 5 1/2"
Flat Nose Pliers

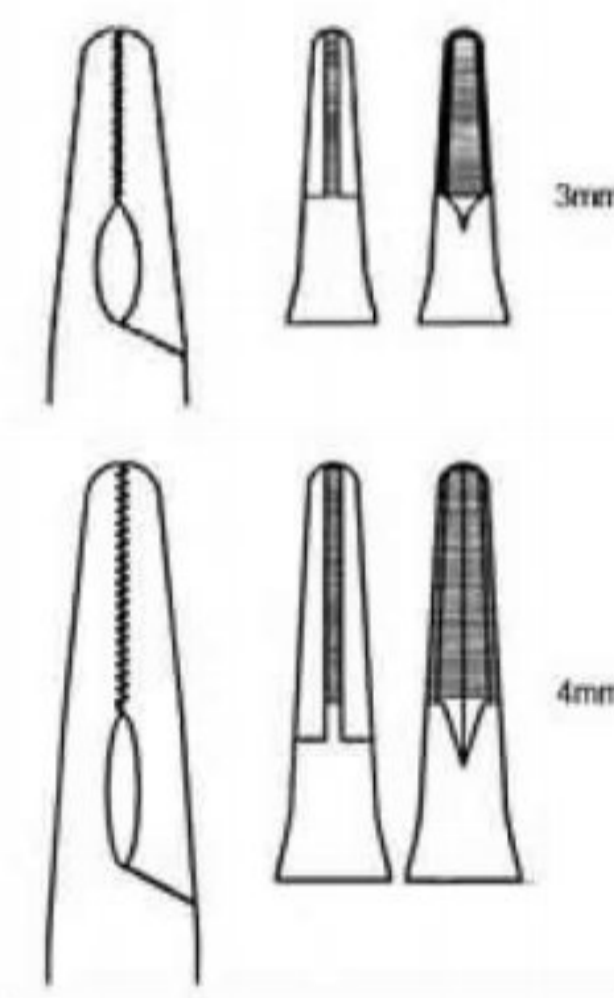

AJ-2169
K-Wire Pliers
A: 13 cm / 5"
B: 17.5 cm / 7"



AJ-2170
19 cm / 7 1/2"
Screw/Pin
Removing Pliers

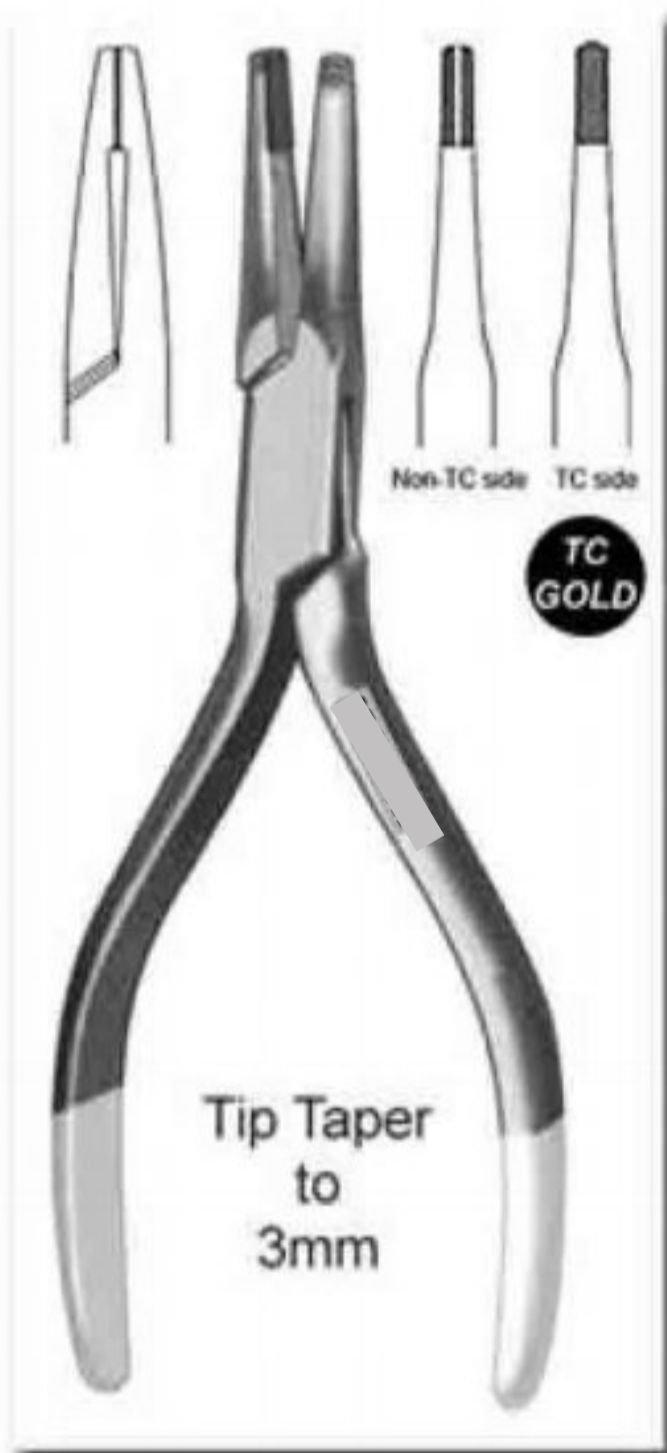

AJ-2171
14 cm / 5 1/2"
Pin Puller
Grips Small Pins

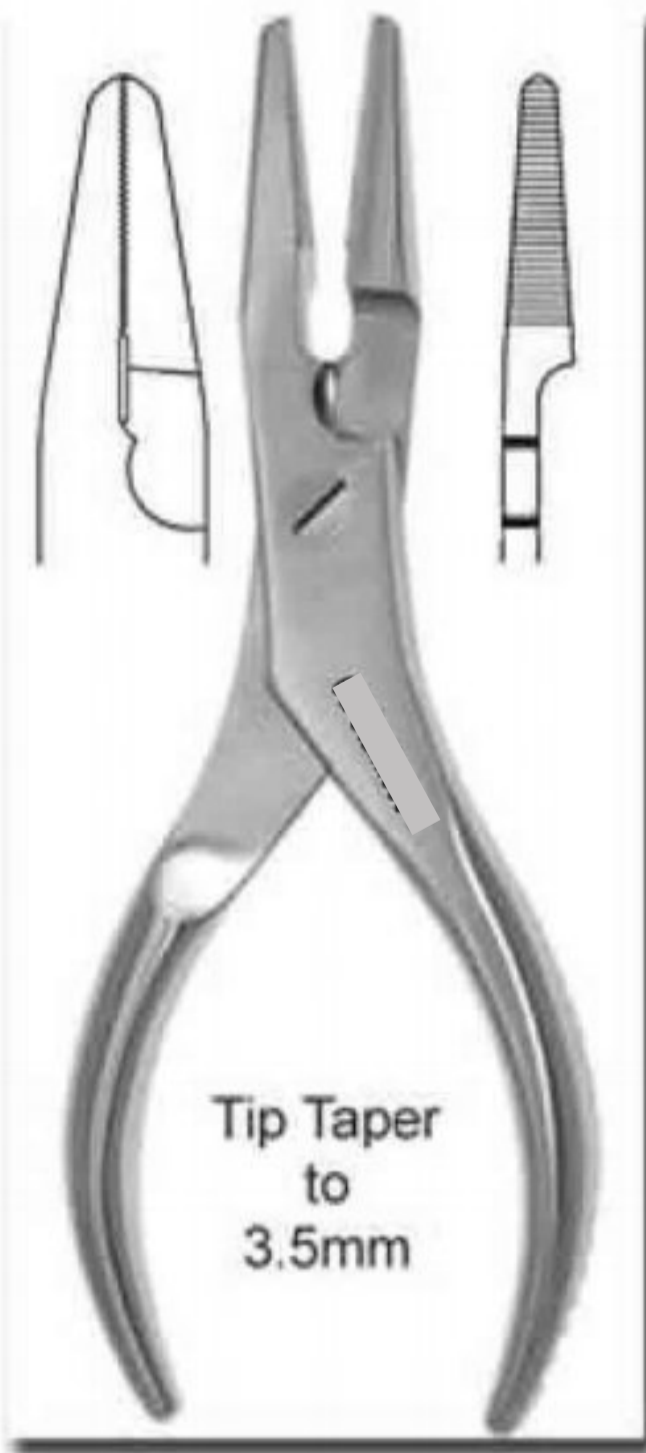

AJ-2172
16 cm / 6 1/2"
Flat Nose Pliers
w/ Cutter
for Cerclage Wire



AJ-2173
19 cm / 7 1/2"
Narrow
Nose Pliers
Heavy Jaws
for Pulling
Wire / Pins



AJ-2174
17.5 cm / 7"
Long Jaw Pliers
2inch Long Jaw
Delicate

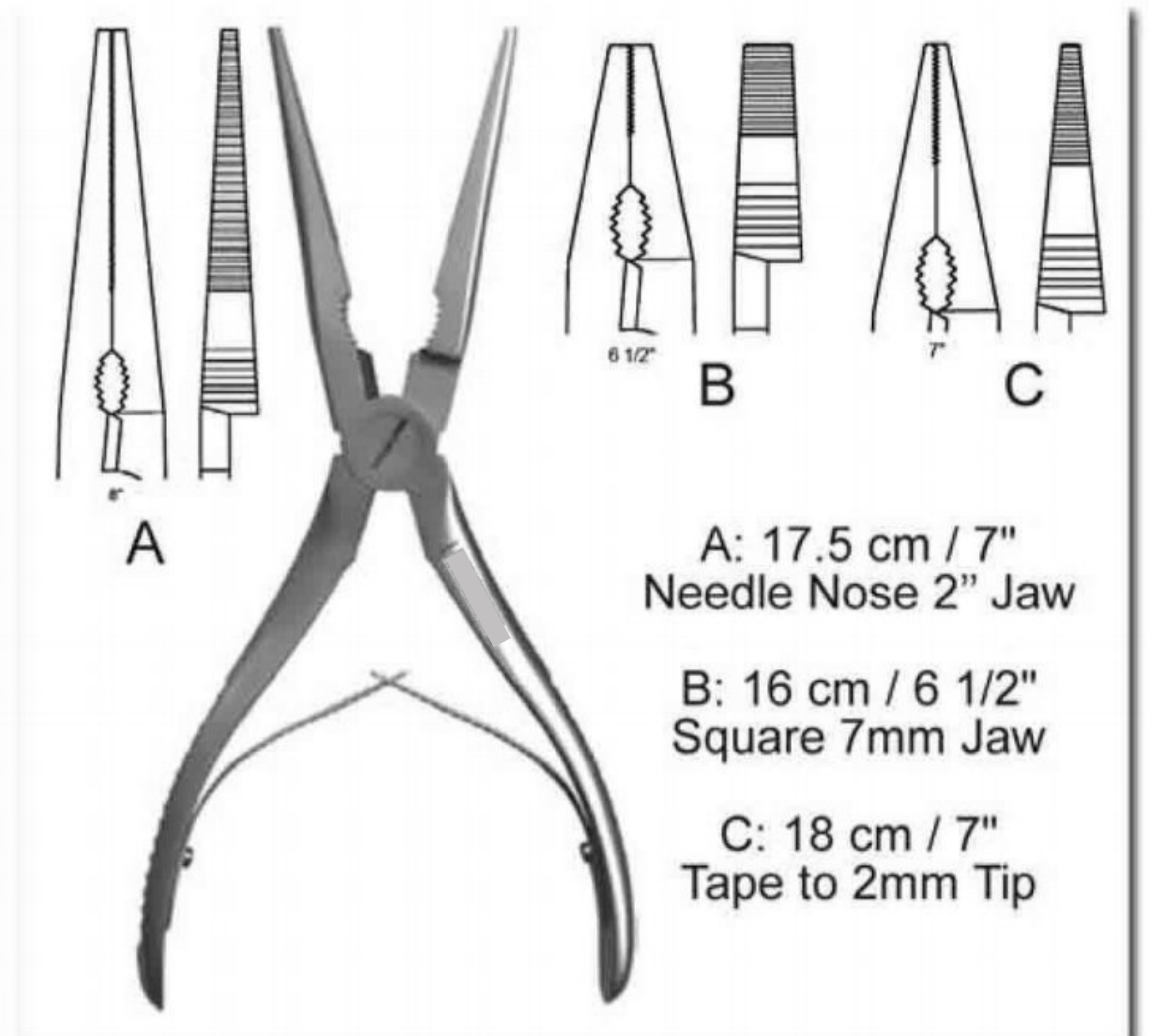

AJ-2175
UNIVERSAL Pliers
Serrated w/ Heavyduty Spring and Cutting Edge
Max Cutting Cap: 1.1mm

BENDING - PASSERS ETC

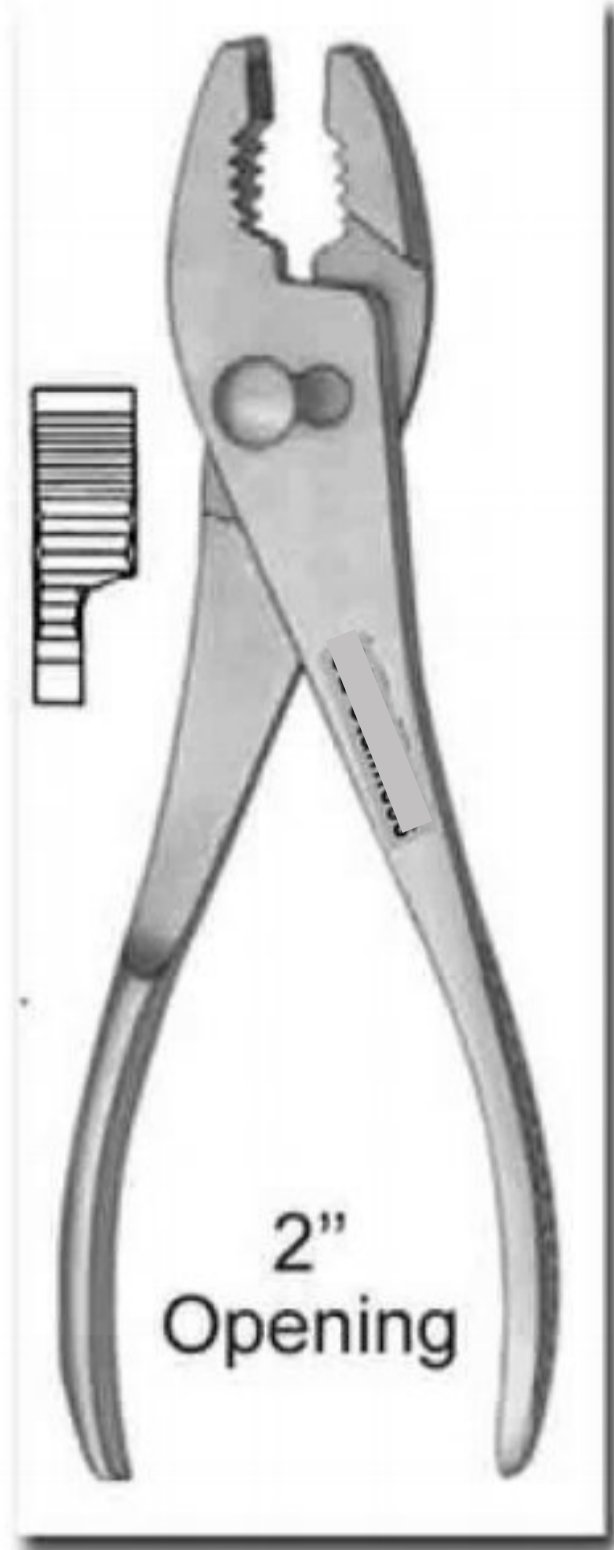

AJ-2176
20 cm / 8"
Slip Joint Pliers

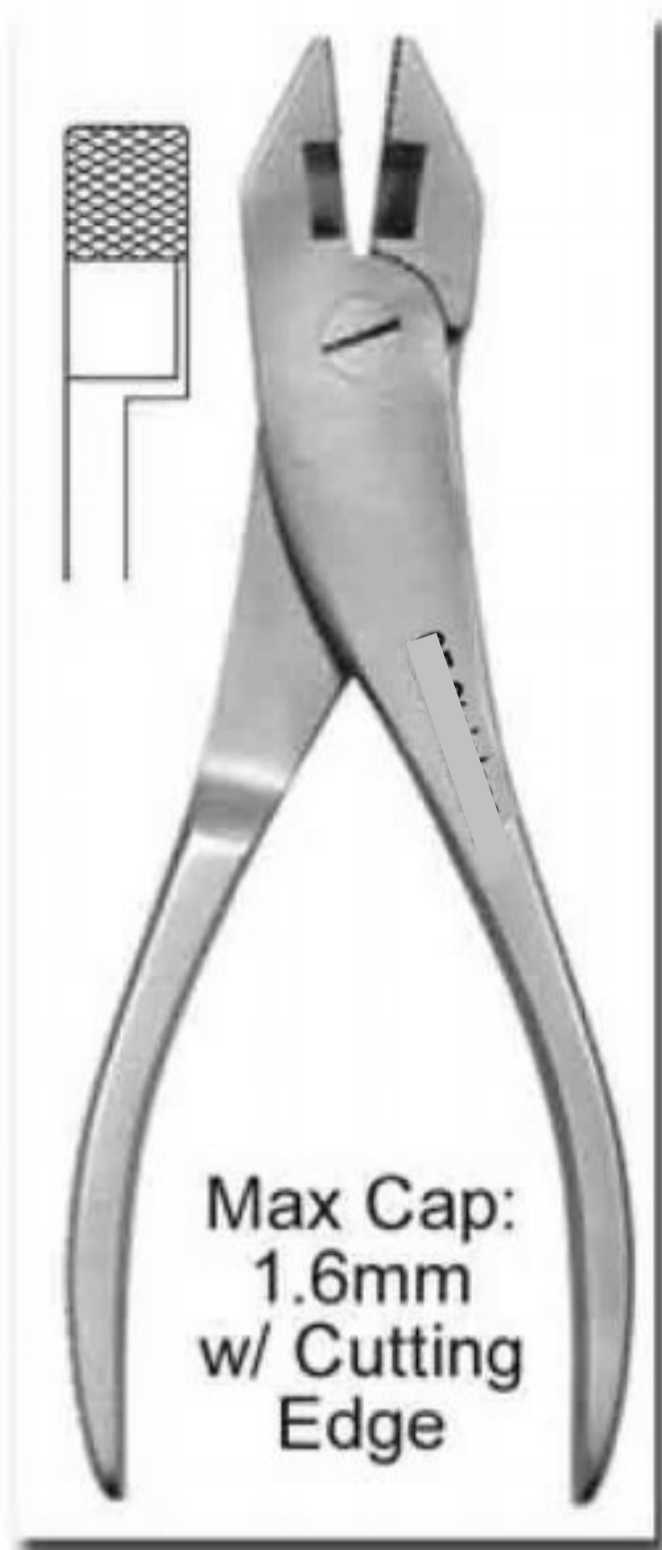

AJ-2177
21 cm / 8 1/2"
Lineman Pliers

All TUNGSTEN CARBIDE

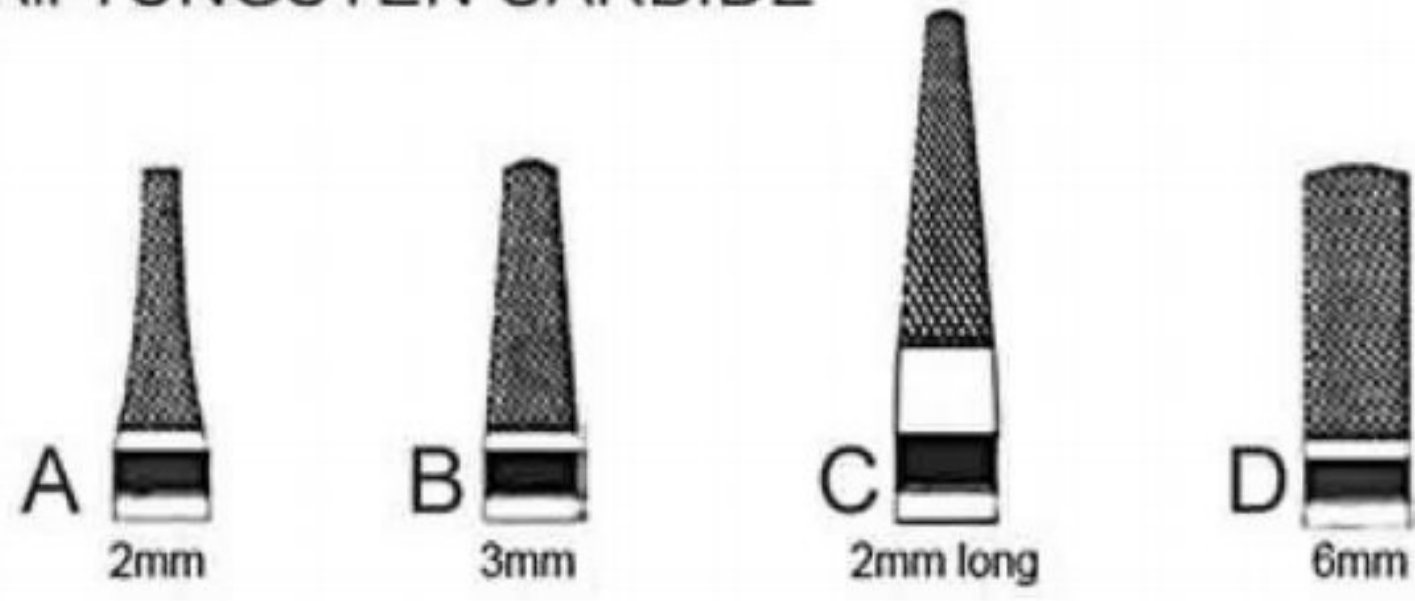

- A: 2mm Delicate Jaw TC
- B: 3mm Jaw TC
- C: 2mm Long Jaw TC
- D: 6mm Jaw TC

AJ-2178
18 cm / 7"
Double Action Wire Extraction Plier

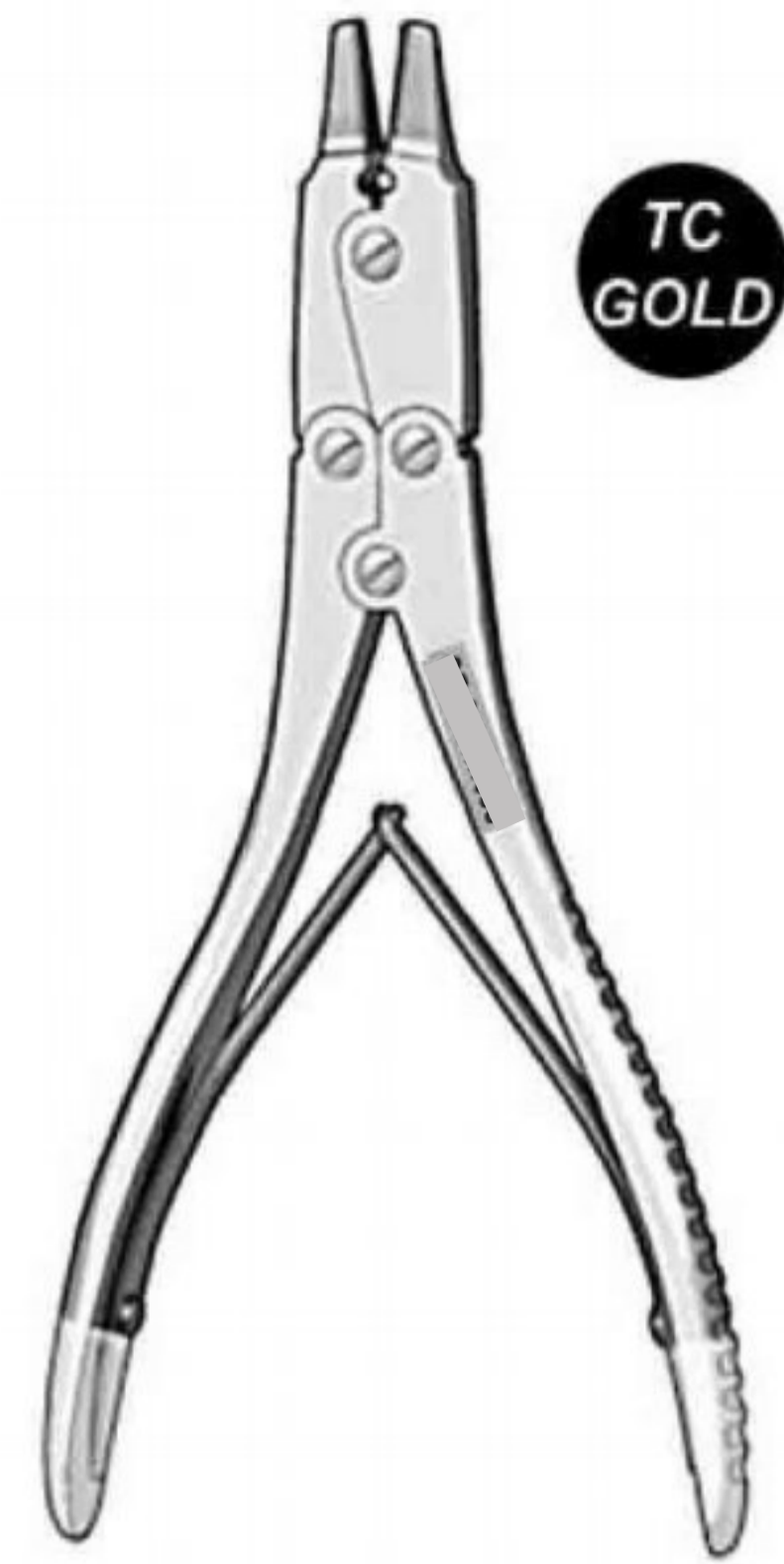

TC GOLD

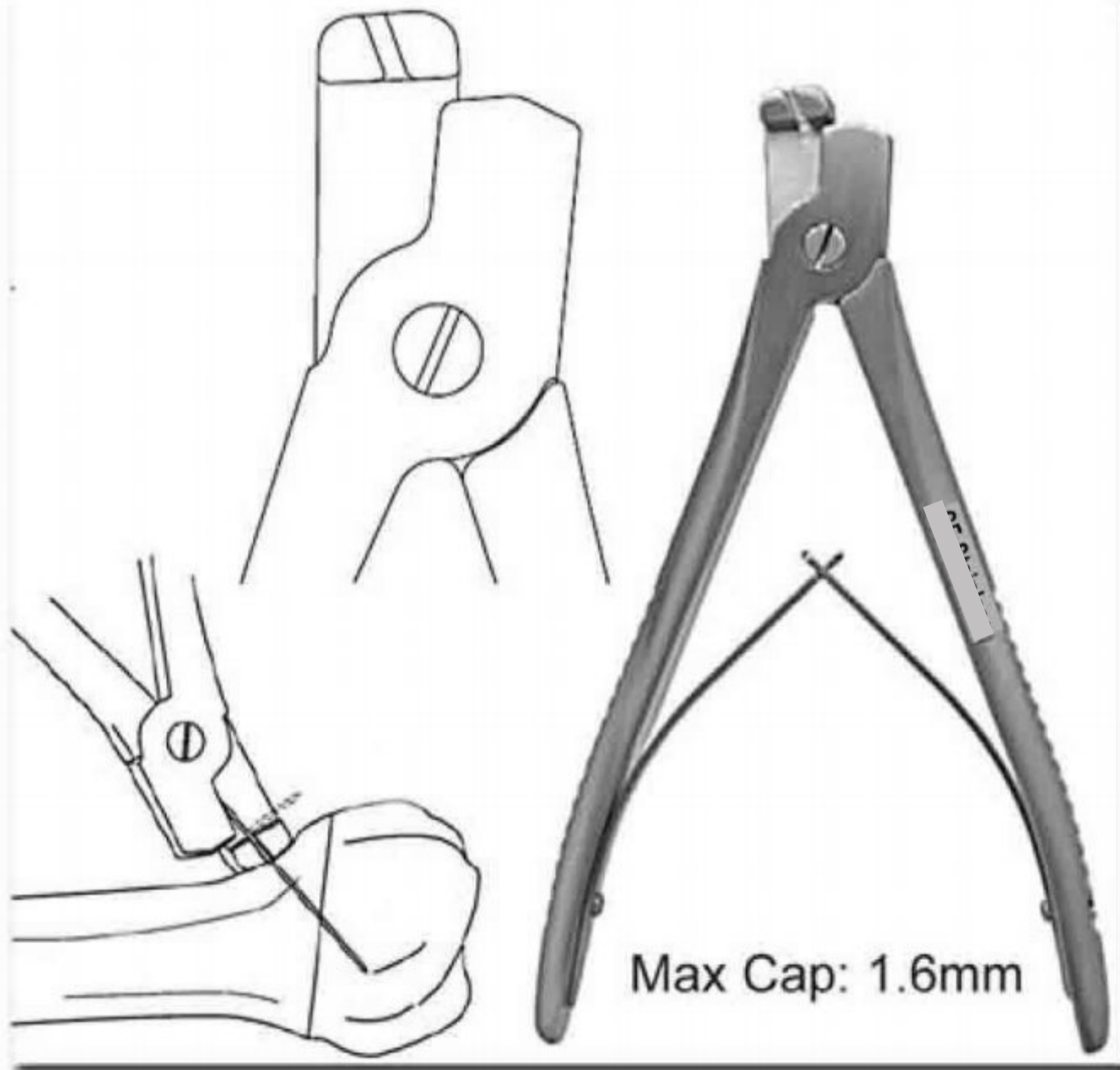

AJ-2179
19 cm / 7 1/2" Gratloch Wire Bender



AJ-2180
13.5 cm / 5"
K-Wire / Plate Bender

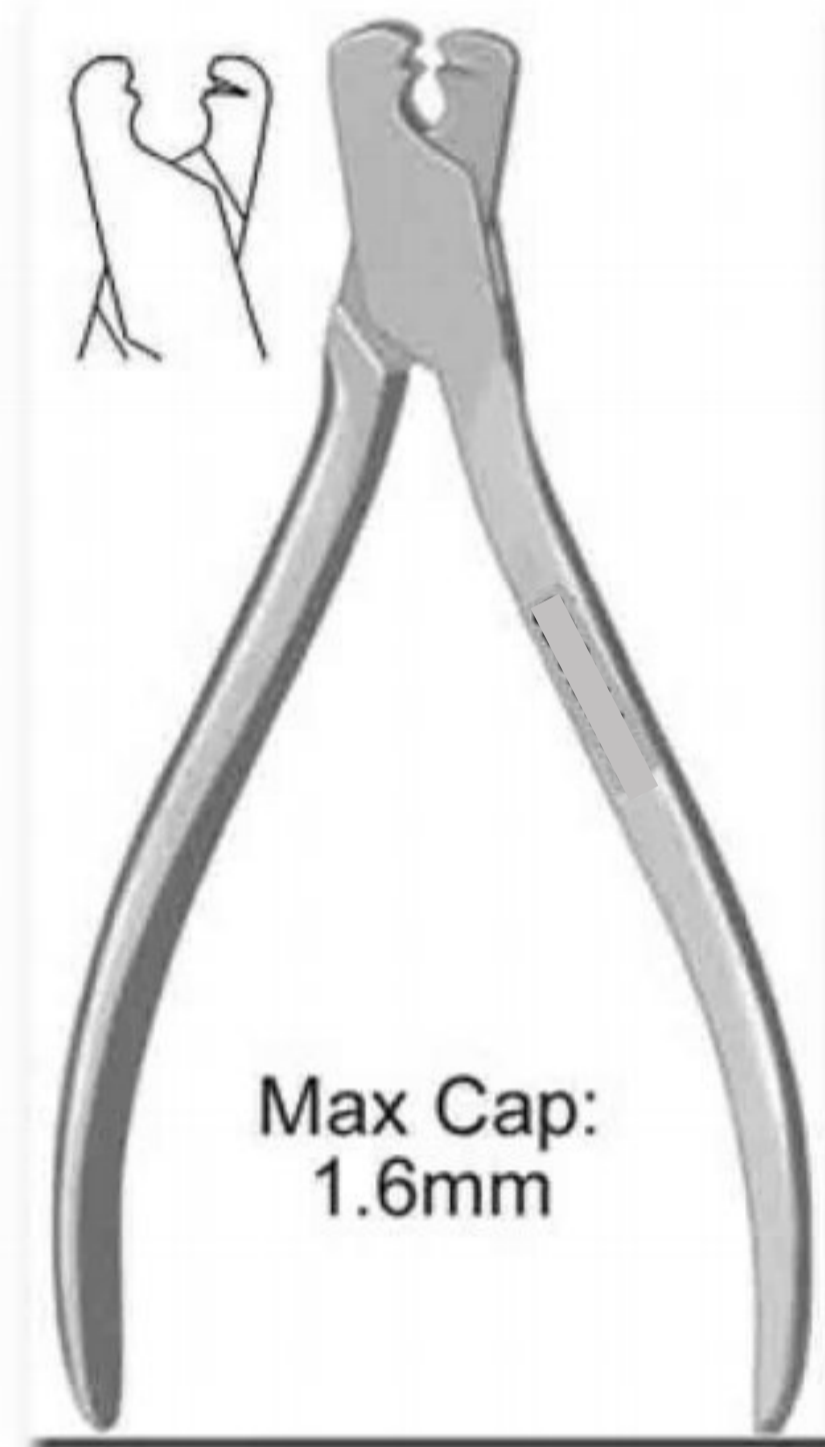

AJ-2181
14.5 cm / 5 1/2"
K-Wire / Plate Bender

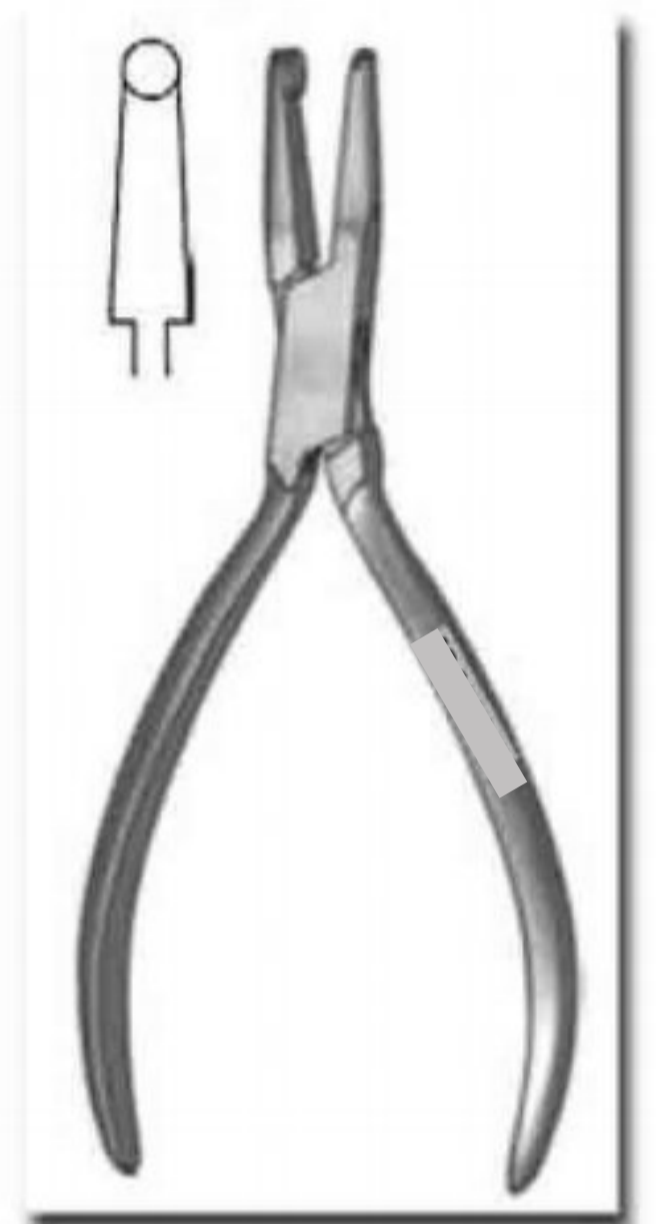

AJ-2182
13.5 cm / 5"
Mini Plate Bending Pliers

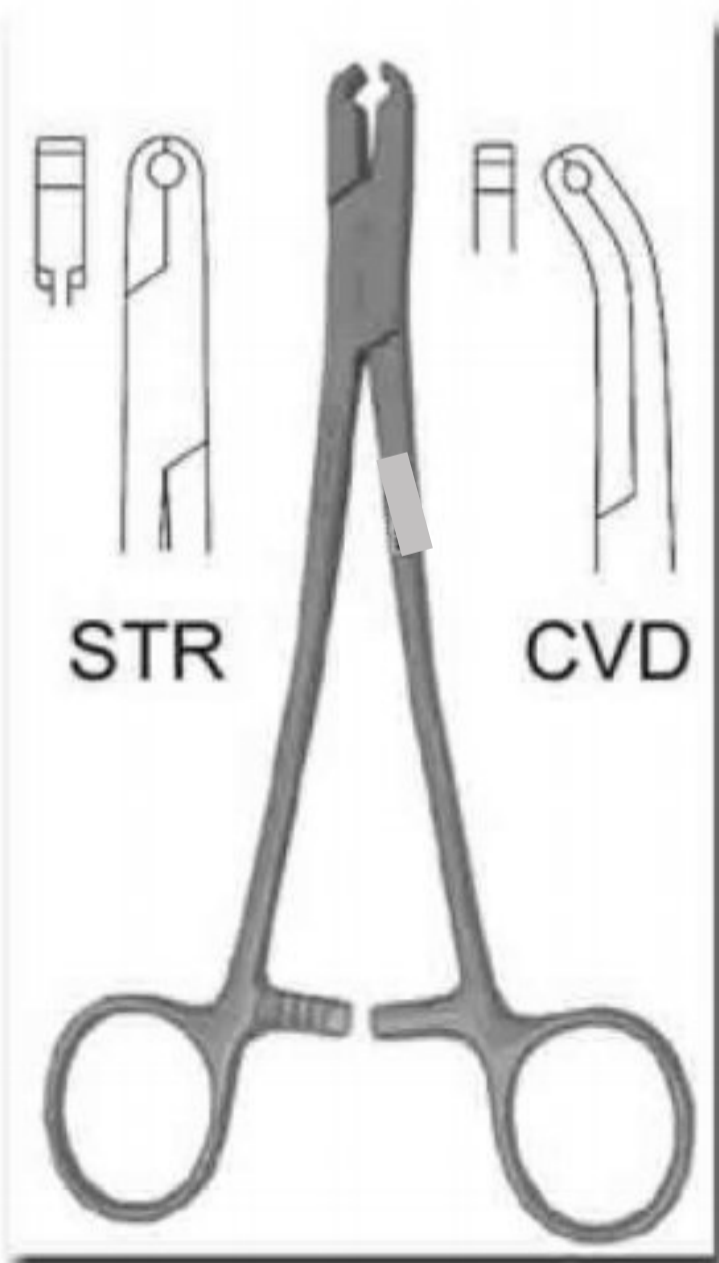

AJ-2183
18 cm / 7 1/4"
Rod Holder
A: 4.0mm Rod
B: 4.76mm Rod
C: 6.35mm Rod
Straight or Curved

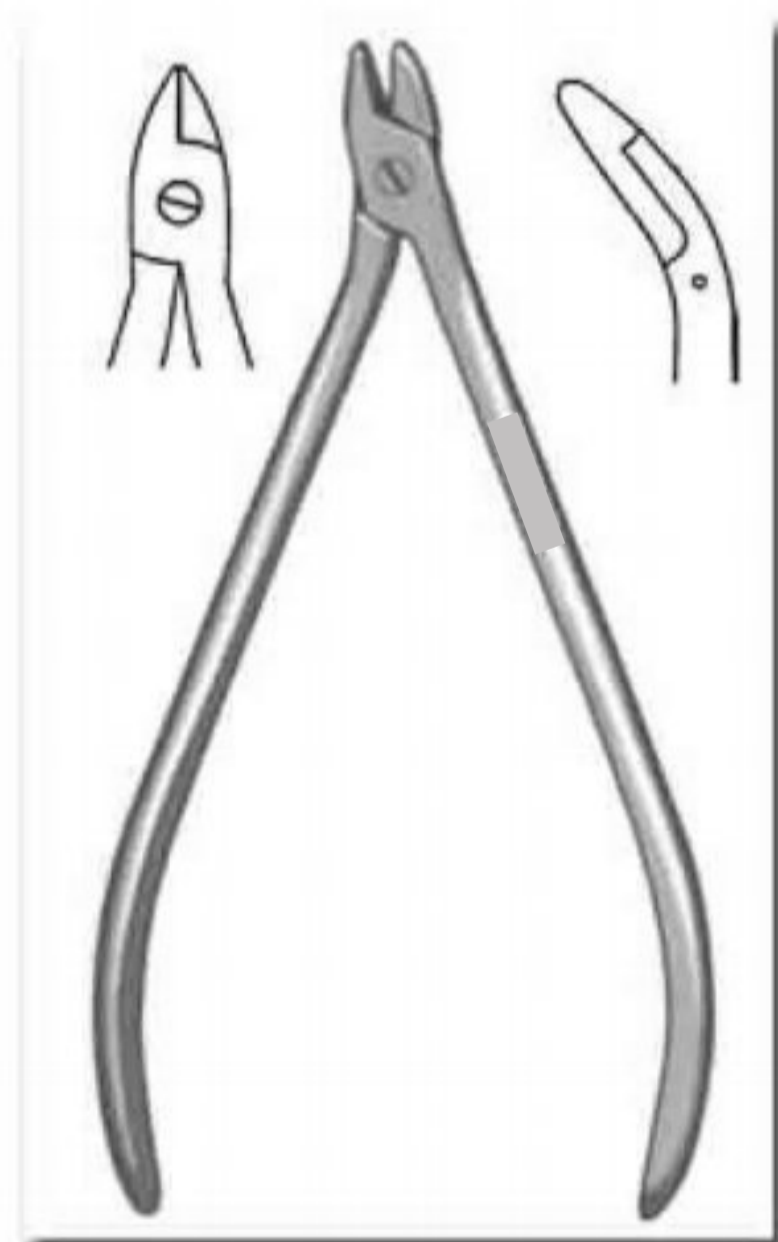

AJ-2184
14.5 cm / 5 1/2"
Plate Bending Pliers



AJ-2185
16 cm / 6 1/2"
Wire Pulling Forceps

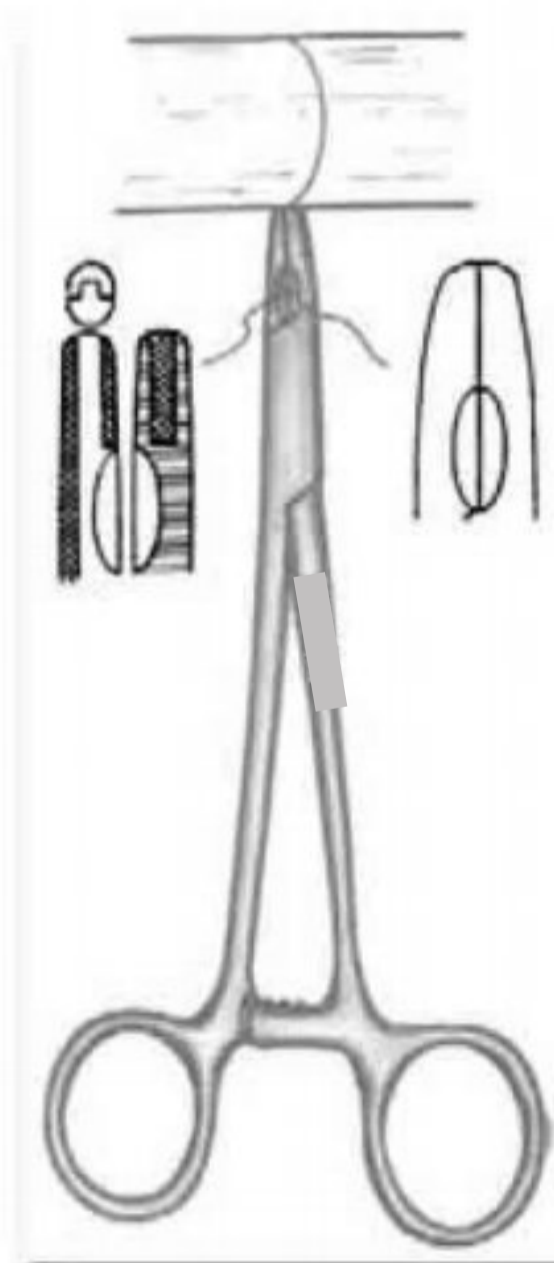

AJ-2186
16 cm / 6 1/4"
Wire Twister / Tightner

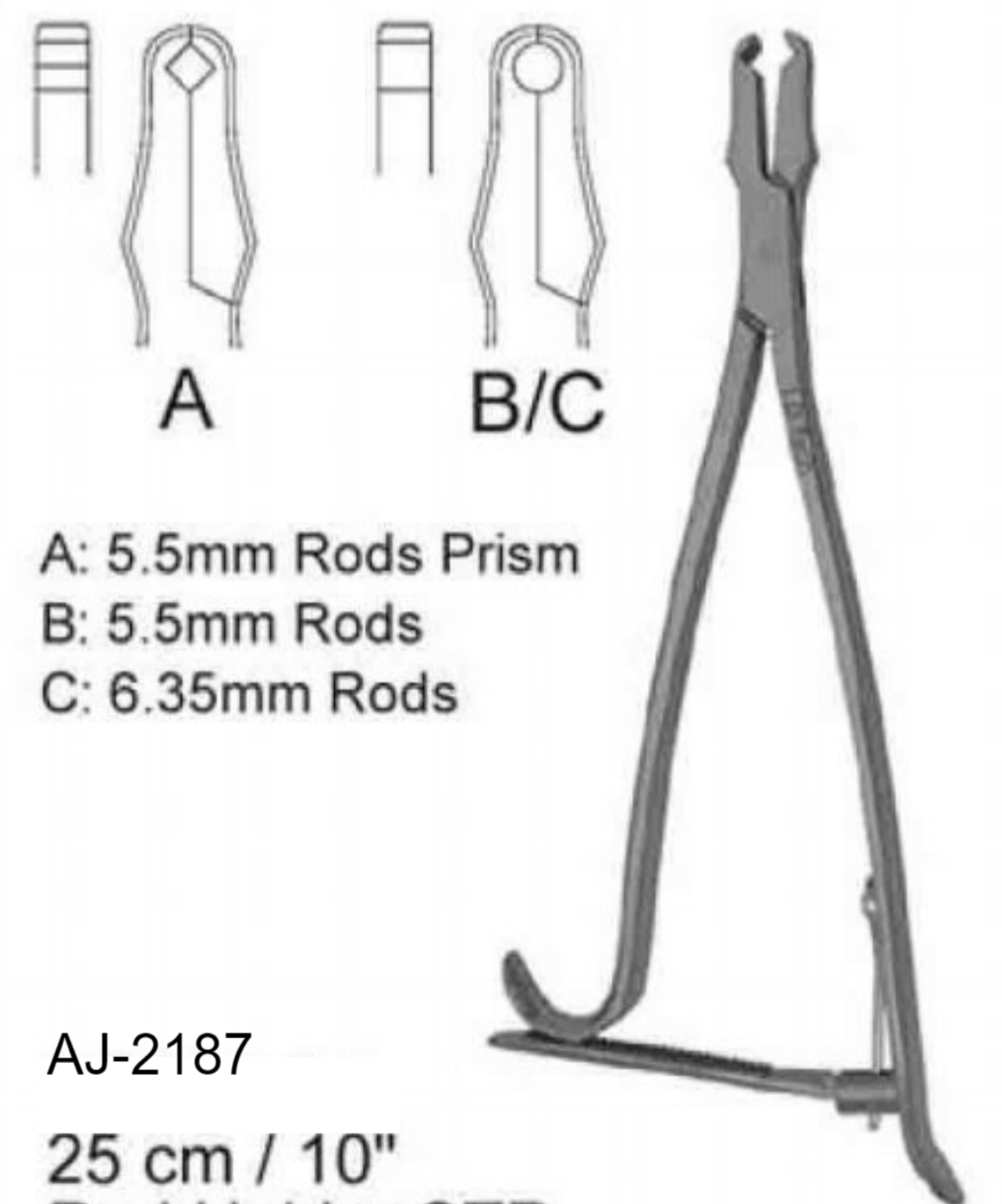

- A: 5.5mm Rods Prism
- B: 5.5mm Rods
- C: 6.35mm Rods

AJ-2187
25 cm / 10"
Rod Holder STR

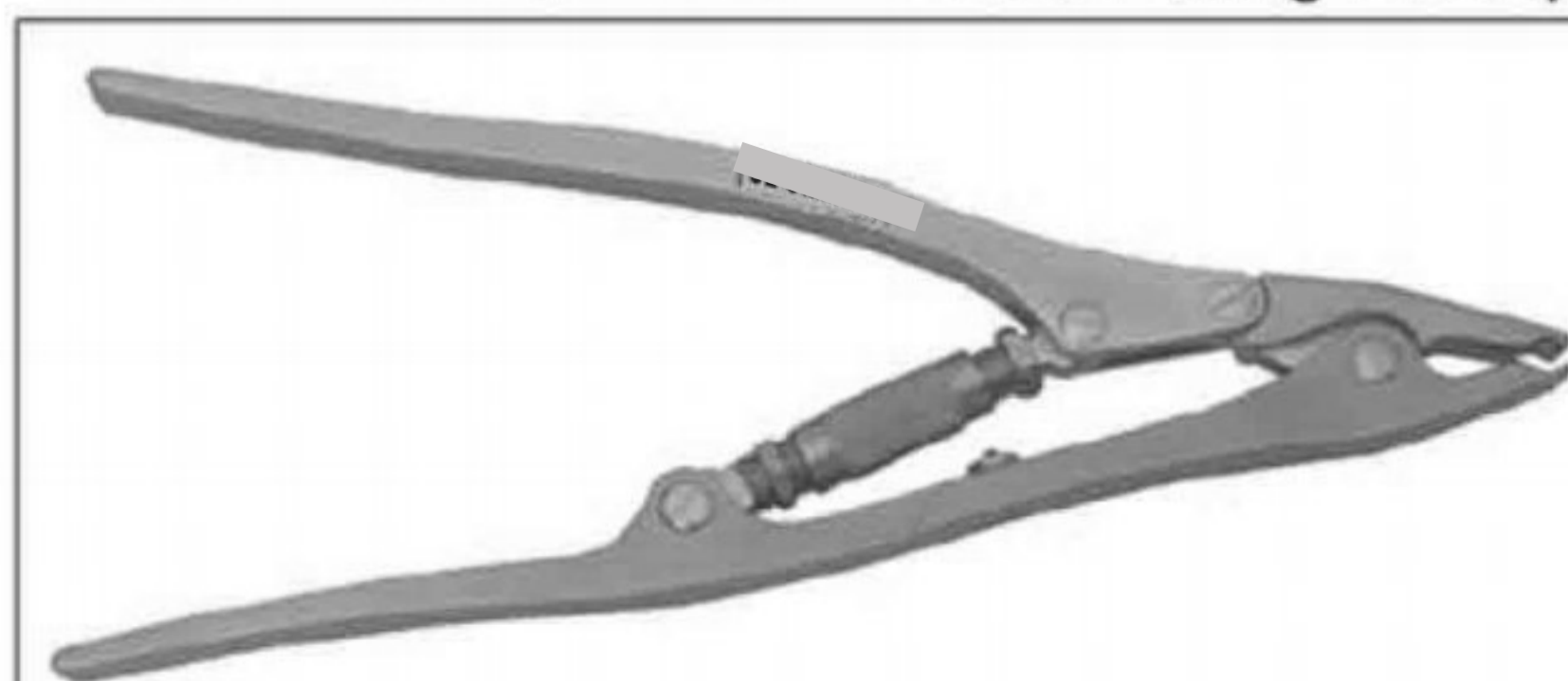

AJ-2188
21 cm / 8 1/2"
Rod Gripper
Adjustable

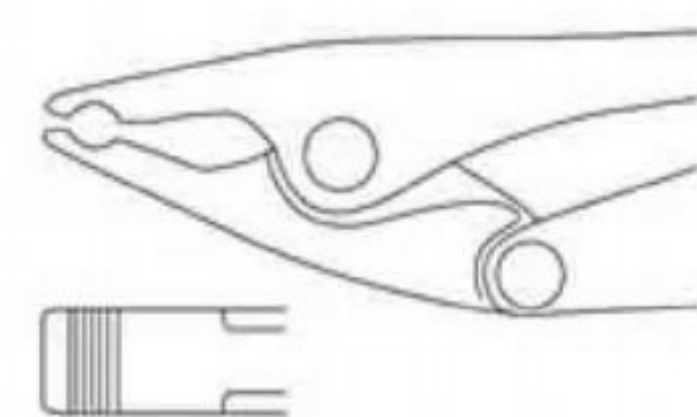

BONE WIRE MANAGEMENT



AJ-2189

Loute Wire Tightener (21 cm / 8 1/4")



AJ-2190
Wire Tightener
w/ T Handle
11 1/2 cm / 4 1/2"



AJ-2191
Wire Tightener 12 cm / 4 3/4")

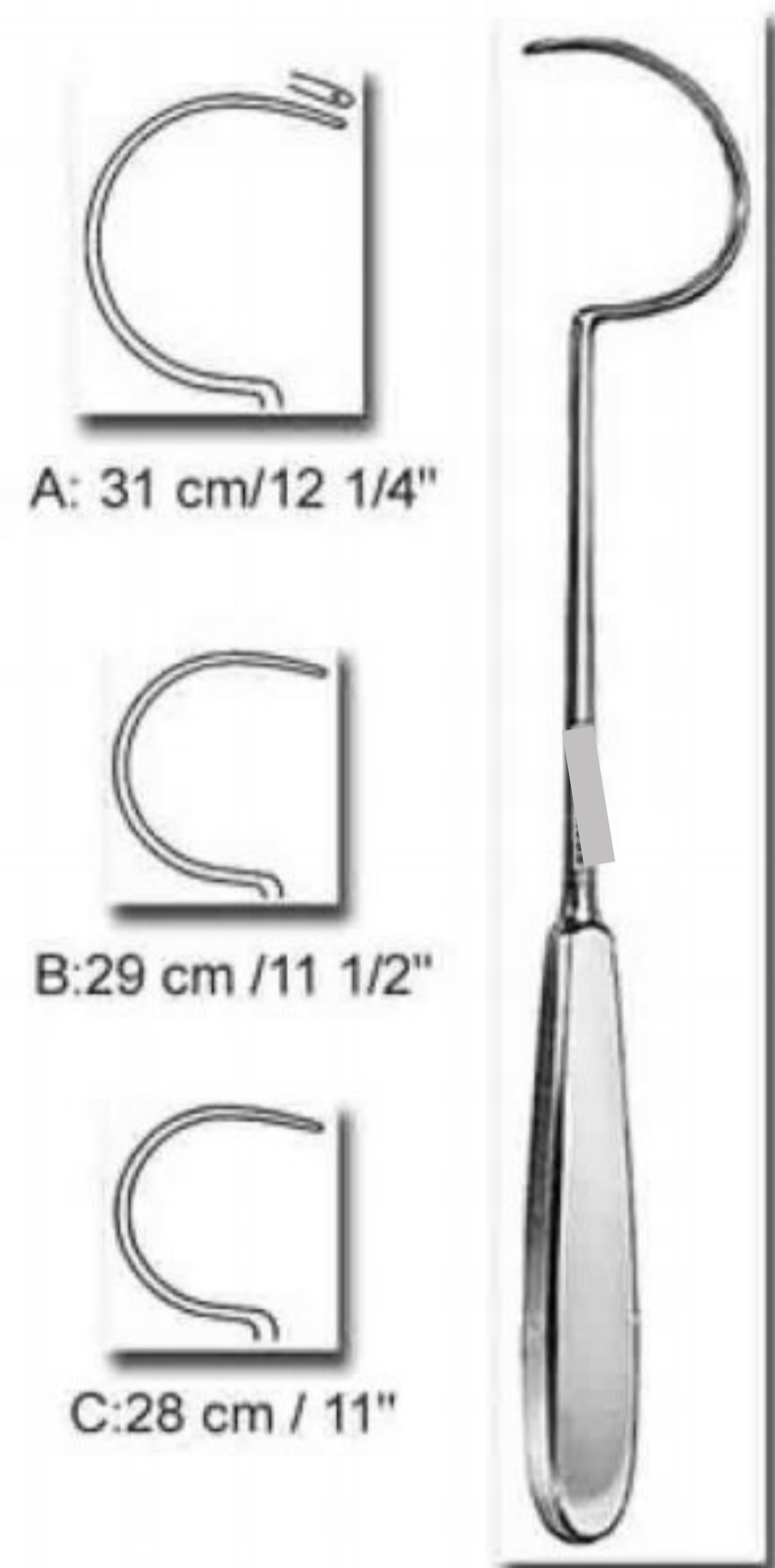

A: 31 cm / 12 1/4"

B: 29 cm / 11 1/2"

C: 28 cm / 11"

AJ-2192

Demel Wire Guide



CVD
Crochet Hook
18cm / 7 1/4"

AJ-2193

Bankert Ligature Carrier



CVD
Crochet Hook
Fiber Handle
A: 18cm / 7"
B: 23cm / 9"

AJ-2194

Suture Passer



CVD
Suture Hole
Fiber Handle
A: 18cm / 7"
B: 23cm / 9"

AJ-2195

Suture Passer

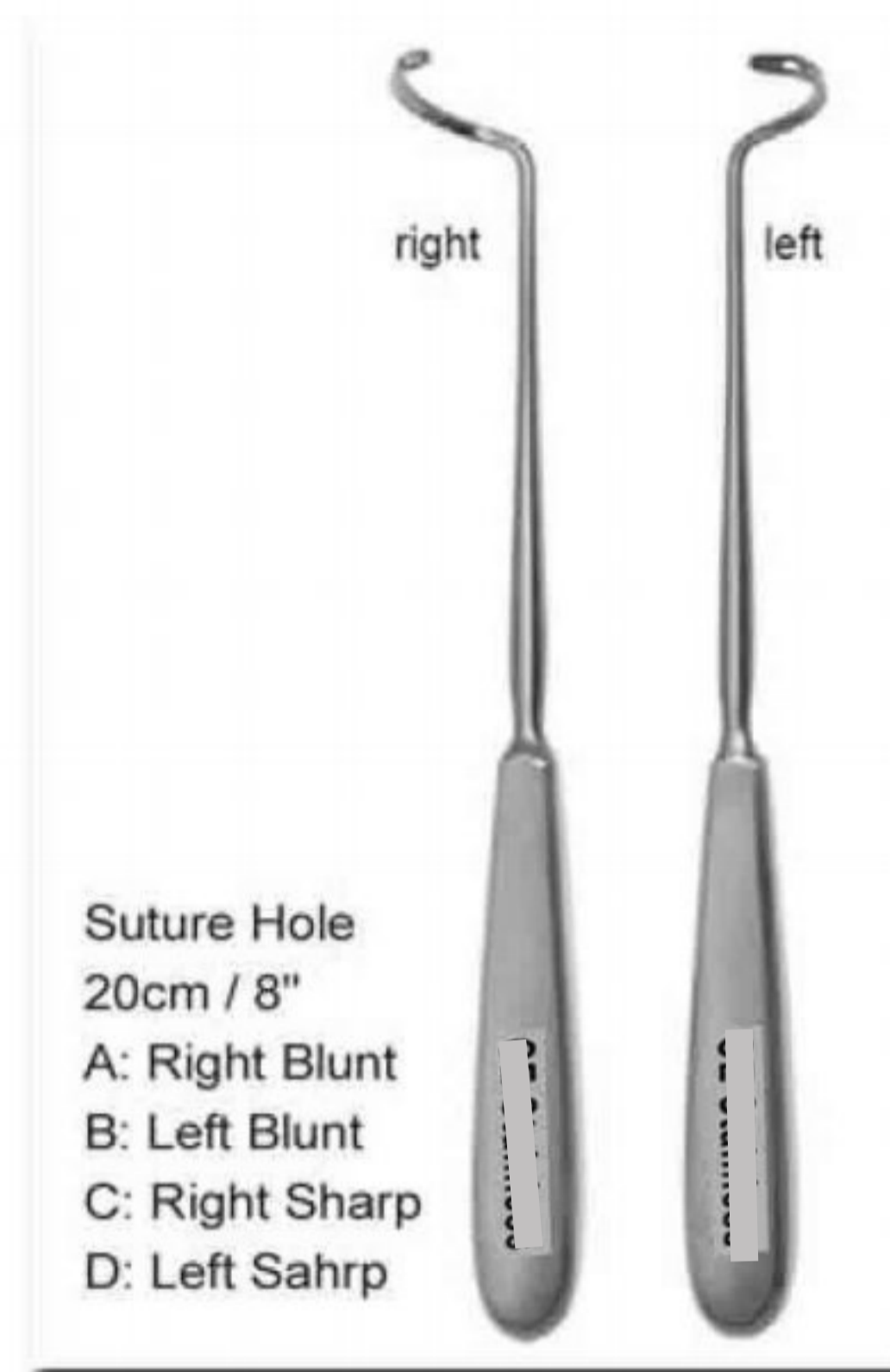

Suture Hole
20cm / 8"
A: Right Blunt
B: Left Blunt
C: Right Sharp
D: Left Sharp

AJ-2196

Deschamps Ligature Carrier

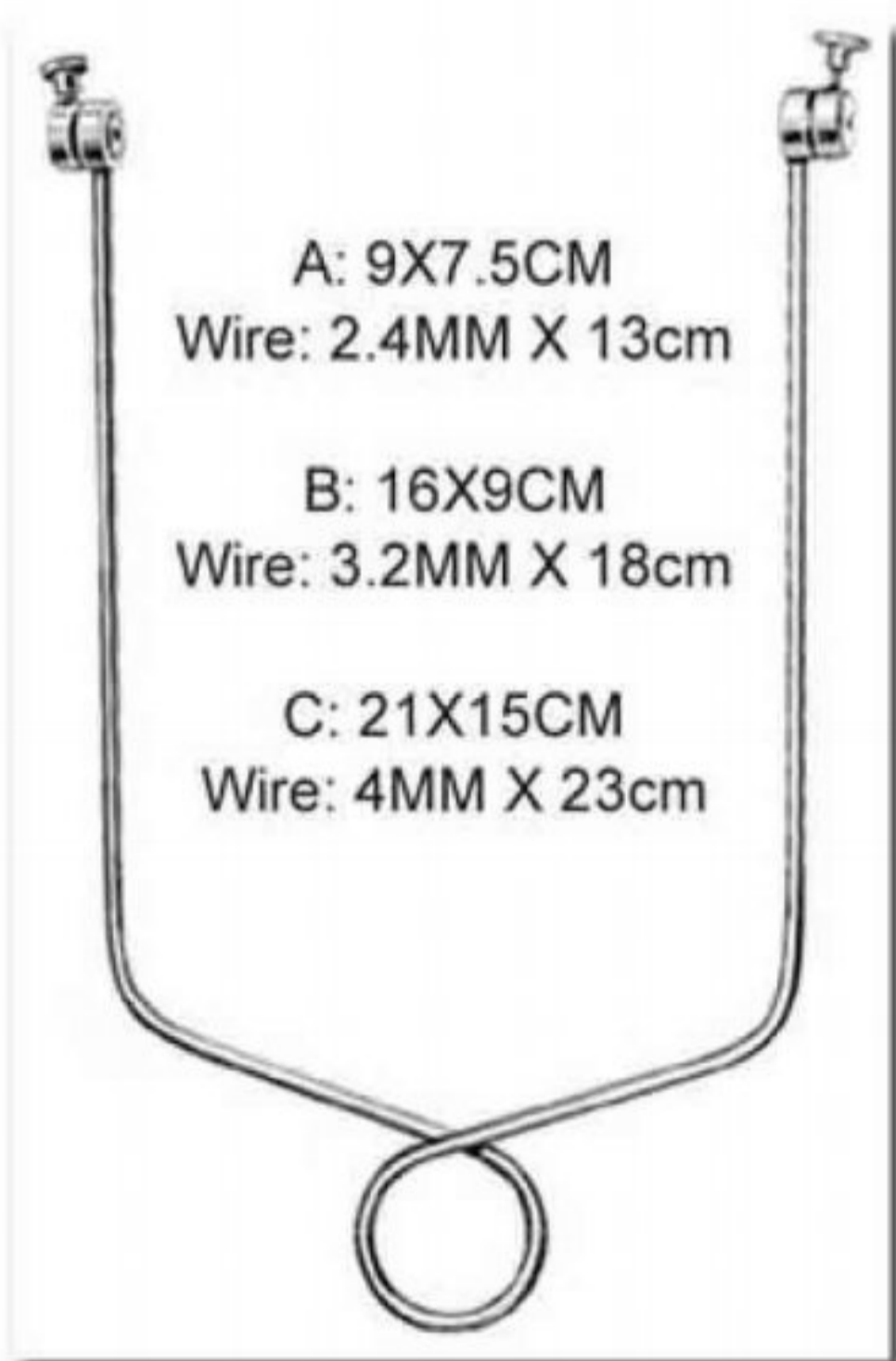

A: 9X7.5CM
Wire: 2.4MM X 13cm
B: 16X9CM
Wire: 3.2MM X 18cm
C: 21X15CM
Wire: 4MM X 23cm

AJ-2197
Böhler Extension
Bow for femur & knee

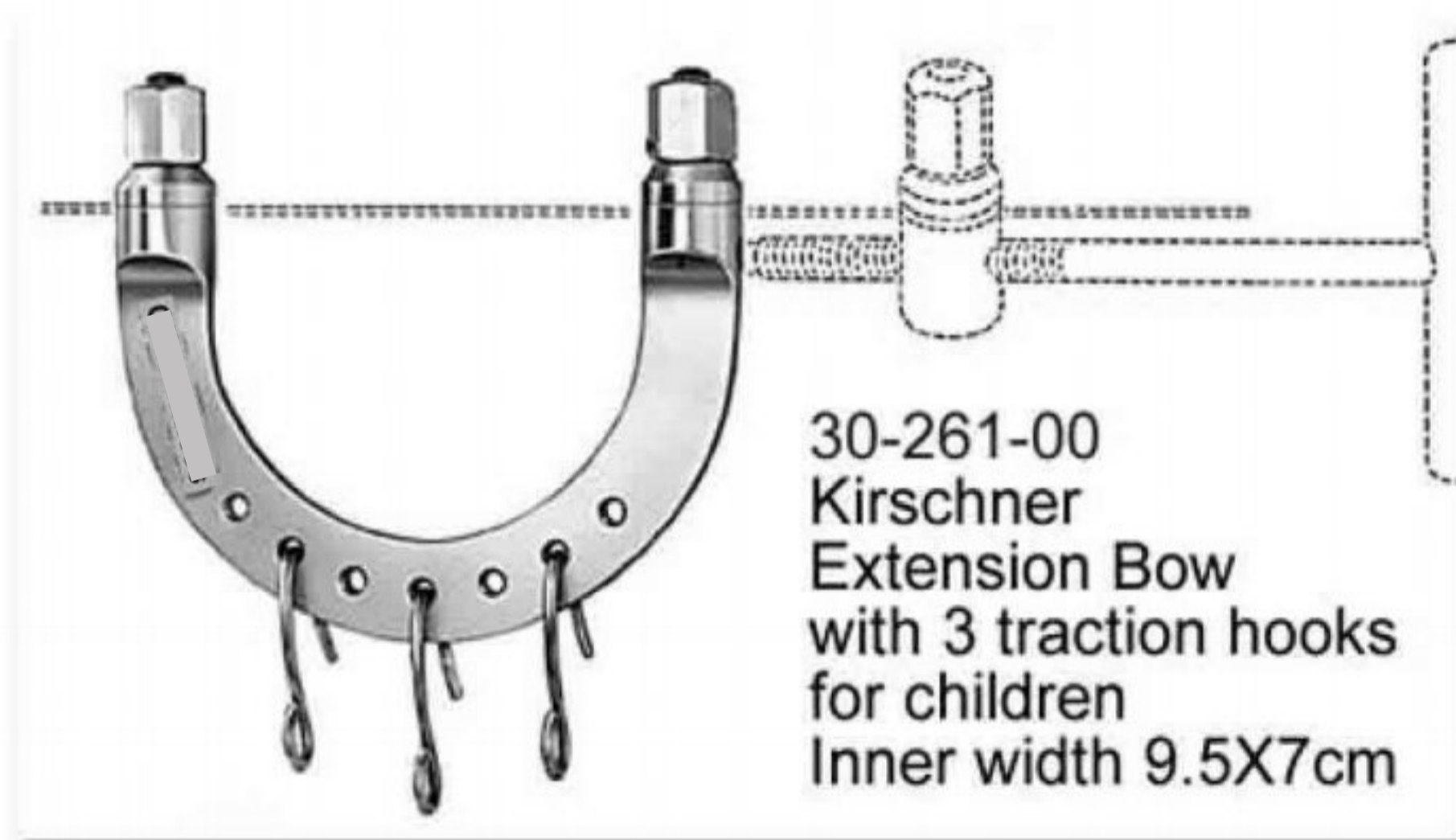

30-261-00
Kirschner
Extension Bow
with 3 traction hooks
for children
Inner width 9.5X7cm

AJ-2198
for Wrist / Ankle
10.5X10.5cm

AJ-2199
for Elbow
12X12cm

AJ-2200
for Knee
15.5X15.5cm

AJ-2201
for Femur
20X15.5cm

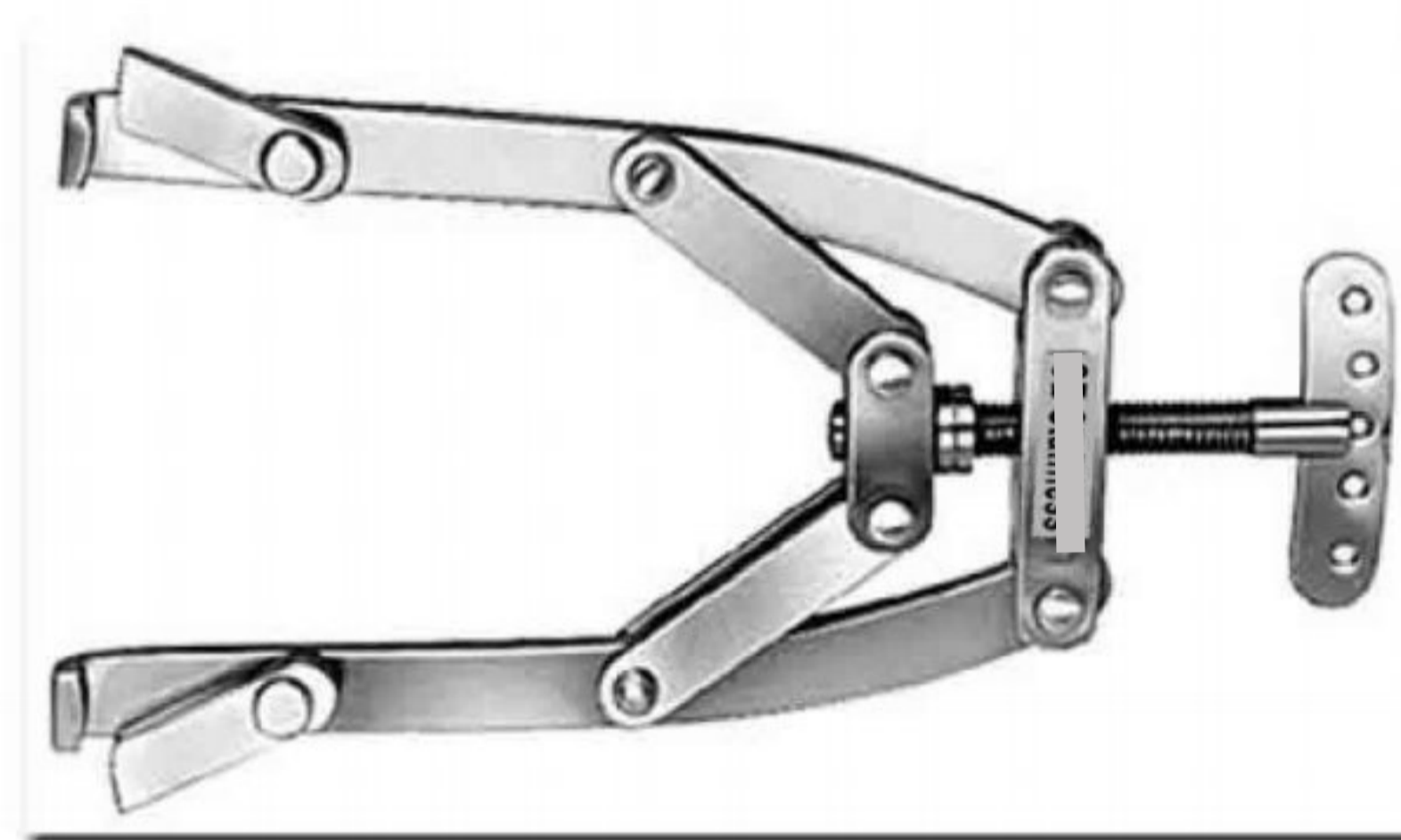

AJ-2202 (Kirschner) Extension Bow
A: Small: 18.5 cm / 7 1/4"
B: Large: 26.5 cm / 10 1/2"
with 3 traction hooks



AJ-2203

Wire Strainer 18.5 cm / 7 1/4"



AJ-2204
Extension Bow
A: 10 1/2" X 6 1/4"
B: 7" X 4"



AJ-2205
Fixation Discs
for wire drills, pair

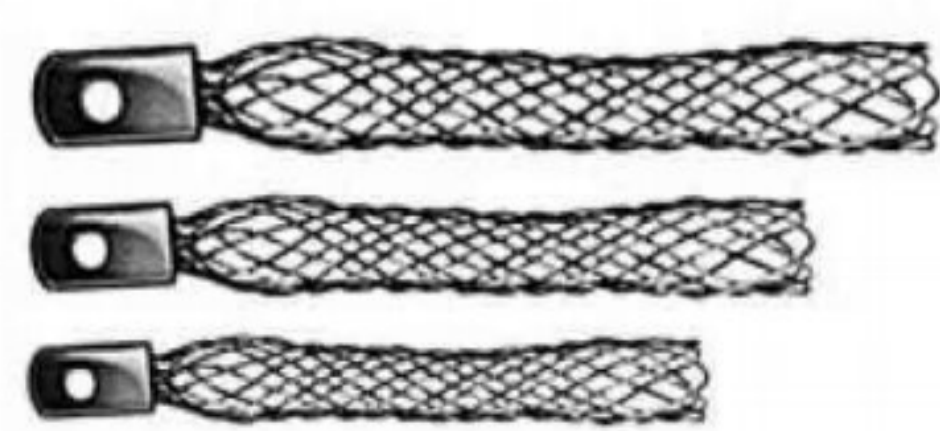

AJ-2207 - Extension Sleeve
Small / Medium / Large



AJ-2206
Traction Hook
for Extension Bows



TT
Wrench 20cm / 8"

FINGER RING CUTTING - LEAD HANDS - BIOPSY TOOLS

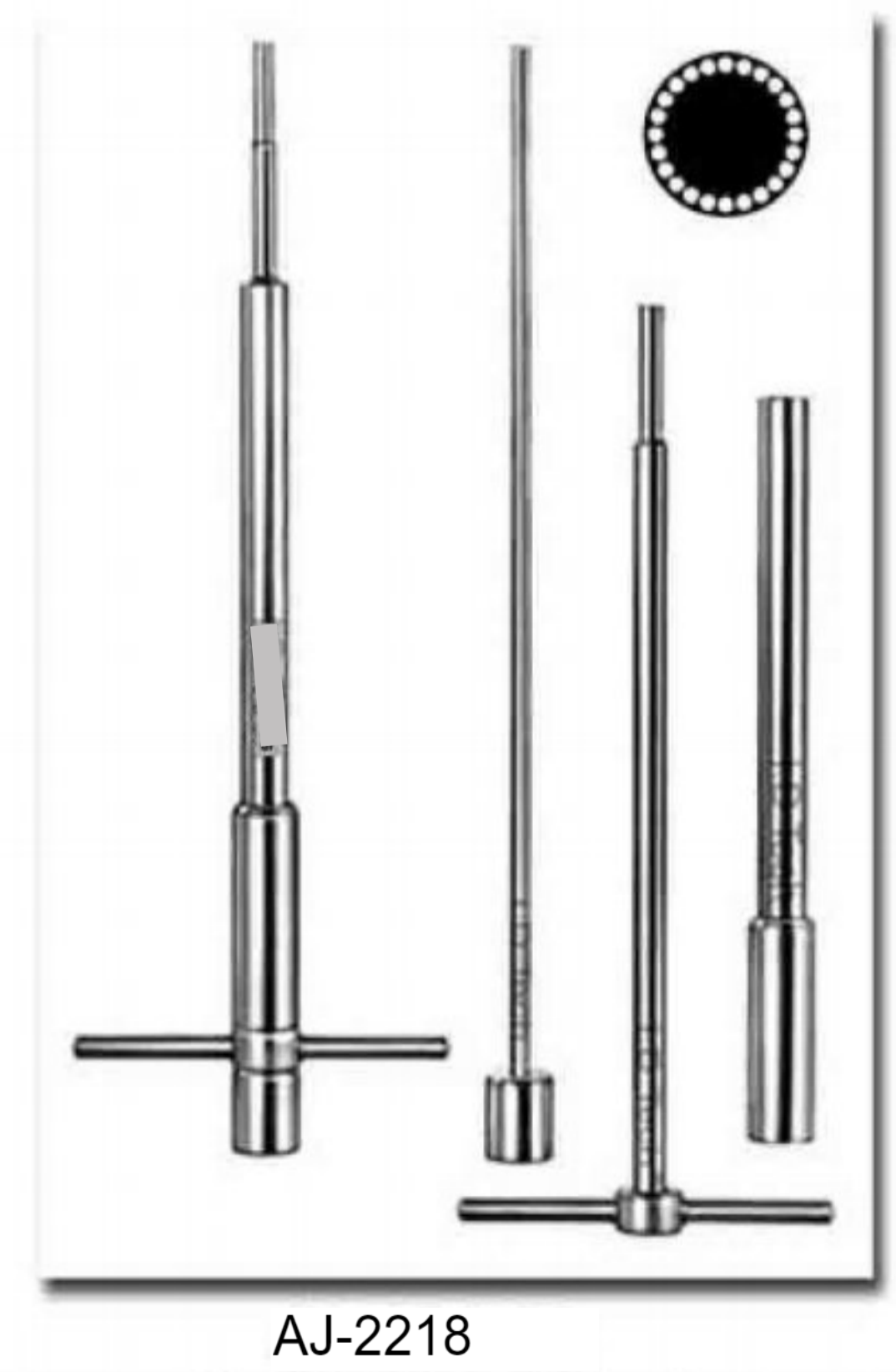
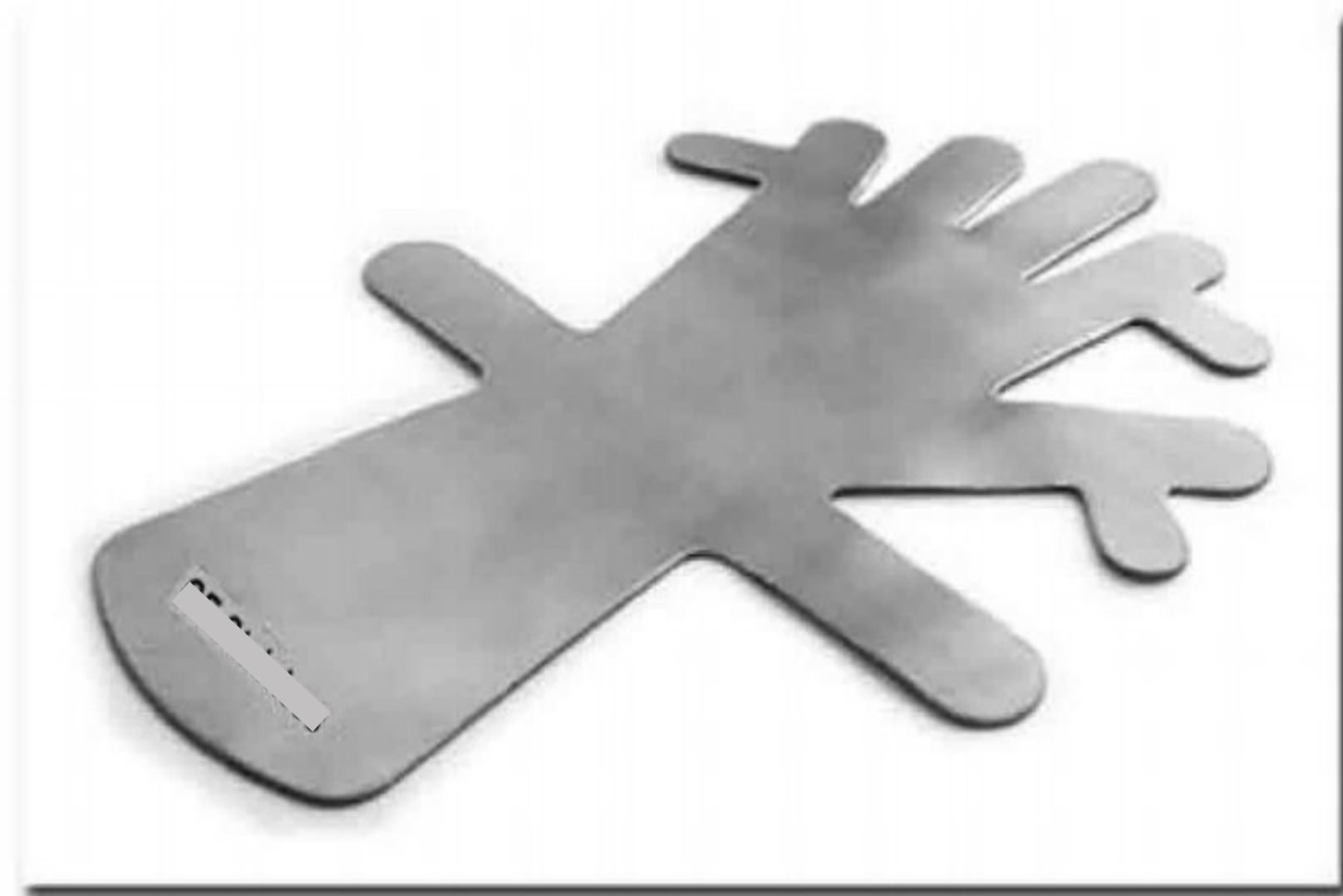
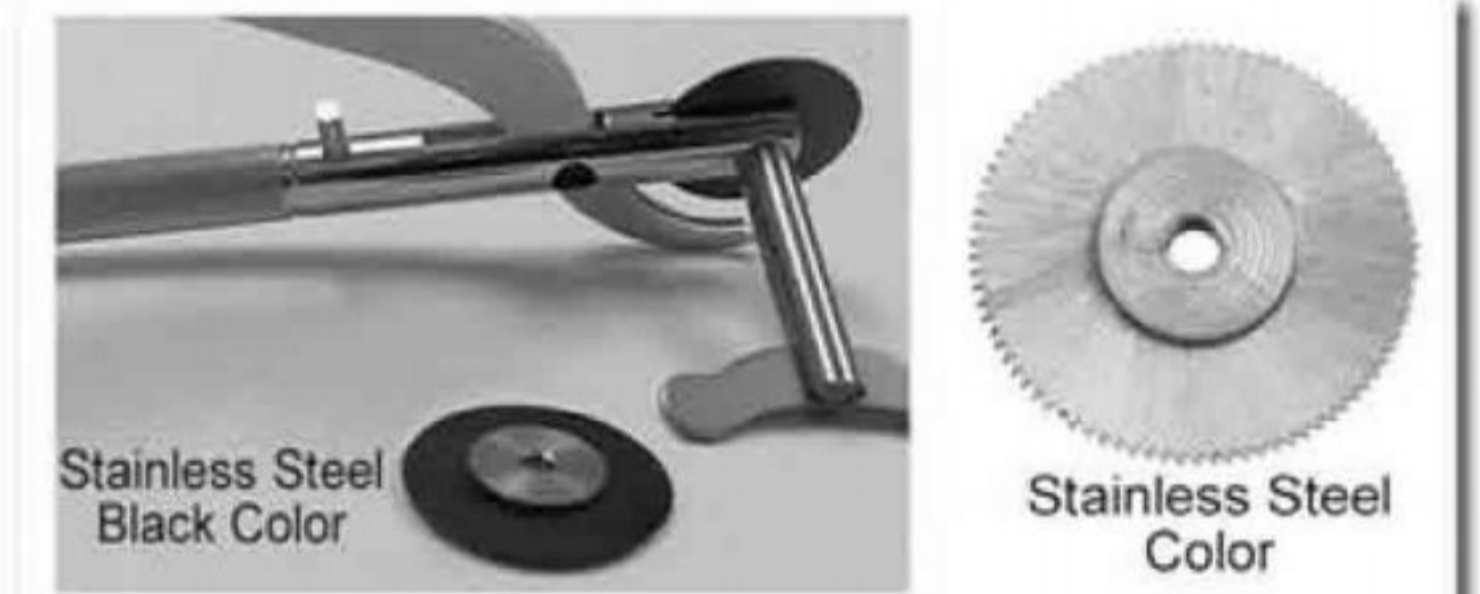
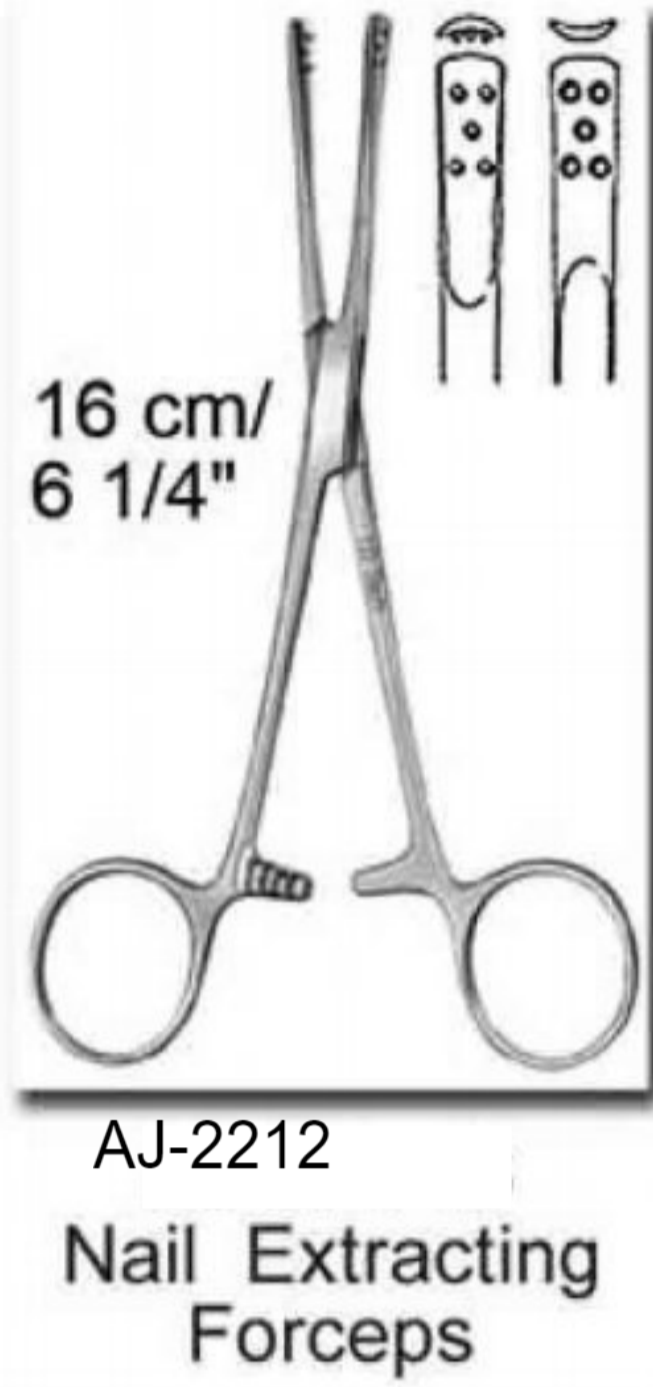
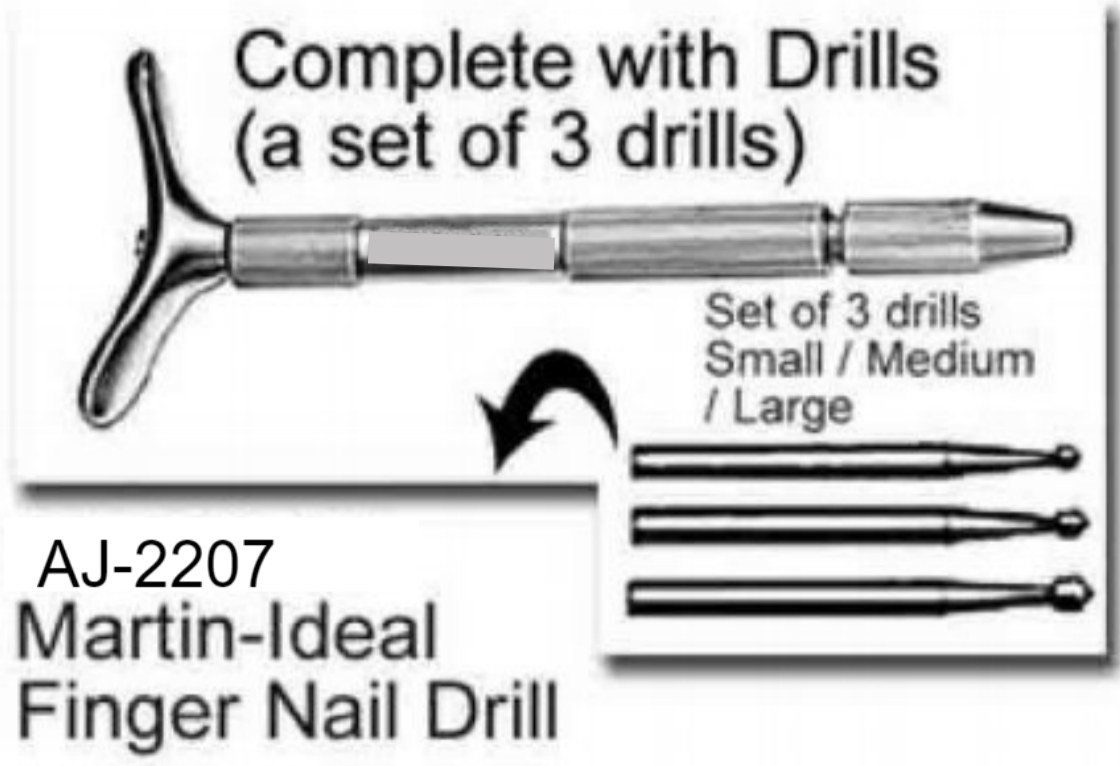

TAMPER - IMPACTORS - PACKERS

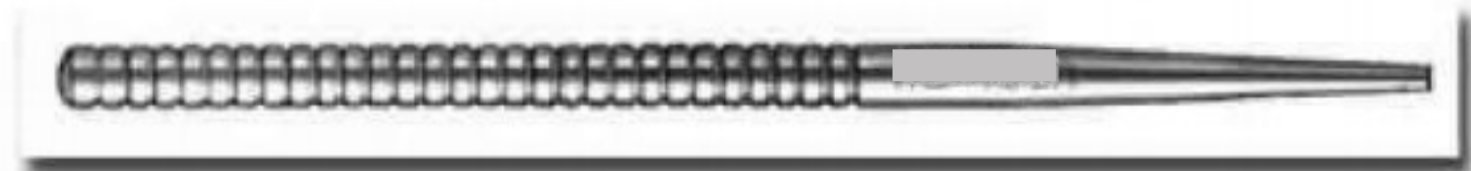

AJ-2219 15.5cm/6" Bone Tamper Tip Sizes: 2-3-4-5-6-8-10mm



A: 2mm
B: 3mm
C: 4mm
D: 5mm
F: 6mm
G: 8mm
H: 9mm
I: 10mm

AJ-2222 Bone Tamper



Knurling Handle

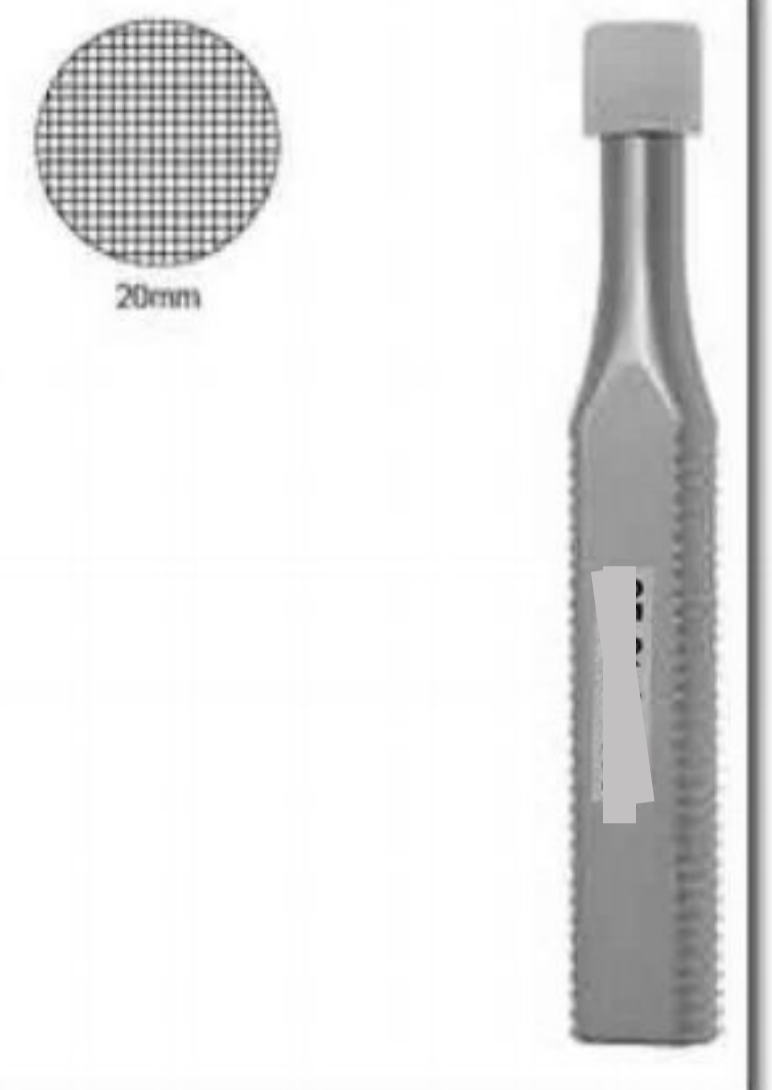

AJ-2220 17cm / 6 1/2" Bone Impactor / Teflon Tip



AJ-2221 20cm / 8" Caspar Bone Tamper

Cross-Serrated
A: 3mm
B: 5mm
C: 8mm



AJ-2223 21cm / 8 1/2" Lumbar / Cervical Impactor

10x4.3mm Micro Offset
10x4.3mm Micro Lateral
16X6.5mm Angled



AJ-2224 21cm / 8 1/2" Lumbar / Cervical Impactor

12.5x7mm Std
12.5x7mm Std Guarded
13x10mm Wide
13x10mm Wide Guarded
11.5x6.5mm Offset
11.5x6.5mm Narrow

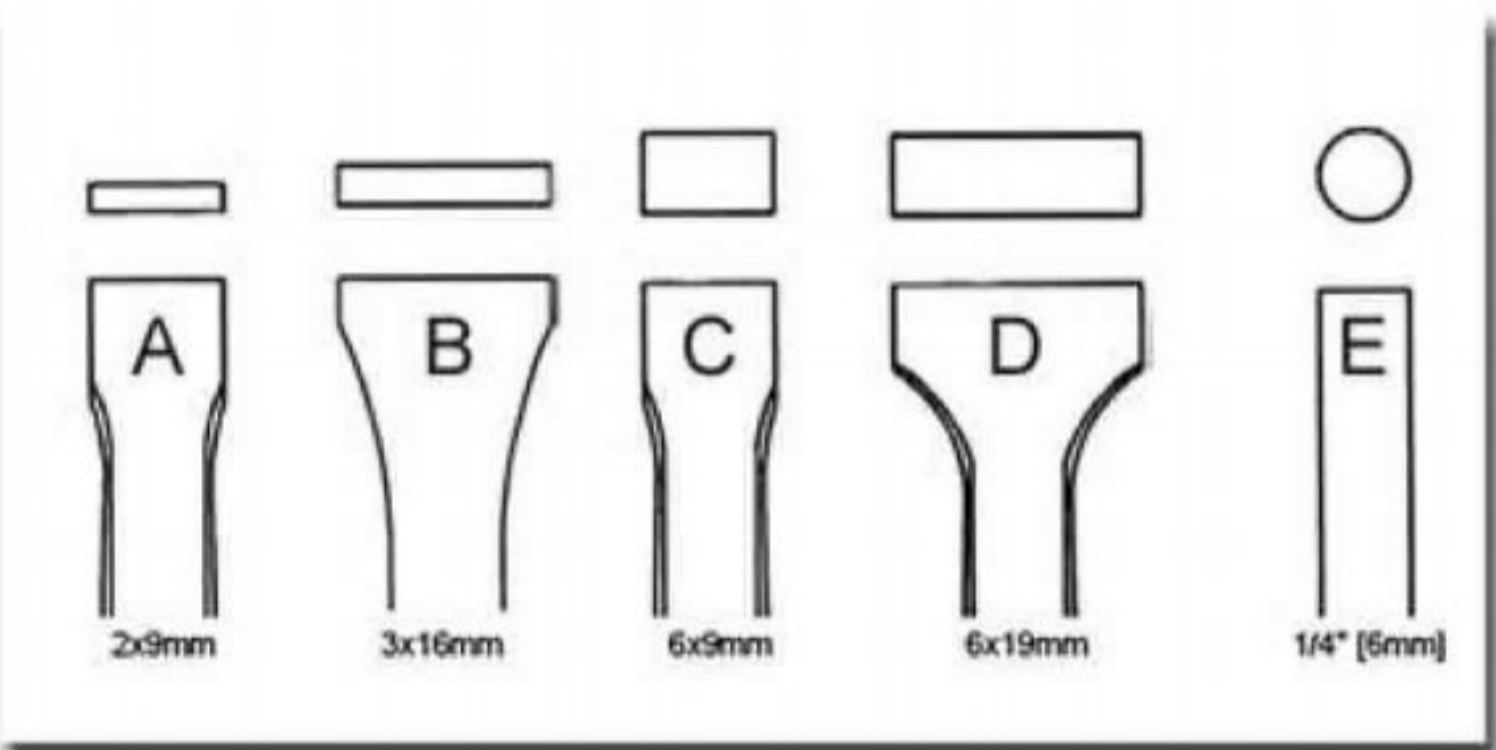

A: 2X9mm B: 3X16mm
C: 6X9mm D: 6X19mm
E: 6mm Dia

AJ-2225 25cm / 10" Bone Chip Packer



AJ-2226 43cm / 17" Bone Tamper



9.5mm DIA



BONE FILES - RASPS



AJ-2227 Putti Bone Rasp Round / Semi Round
30cm / 11 3/4"



AJ-2228 Putti Bone Rasp Curved / Straight
27cm / 10 3/4"



AJ-2229 Bone File 28 cm / 11" w/ Hollow Handle
Semi Round



AJ-2230 Bone File 24.5 cm / 9 3/4"
w/ Hollow Handle Semi Round



AJ-2231 Bone File 22 cm / 8 3/4"
Flat / Round



AJ-2232 Bone Rasp 22 cm / 8 3/4"
Flat / Round



AJ-2233 Bone File 18 cm / 7"
Fibre Handle / Cross-Hatch



AJ-2233 Bone File 18 cm / 7"
Fibre Handle / Linear



AJ-2233 Bone File 18 cm / 7"
Fibre Handle / Straight



AJ-2234 Bone File 18 cm / 7"
Fibre Handle / CVD Forward



AJ-2235 Bone File 18 cm / 7"
Fibre Handle / CVD Backward

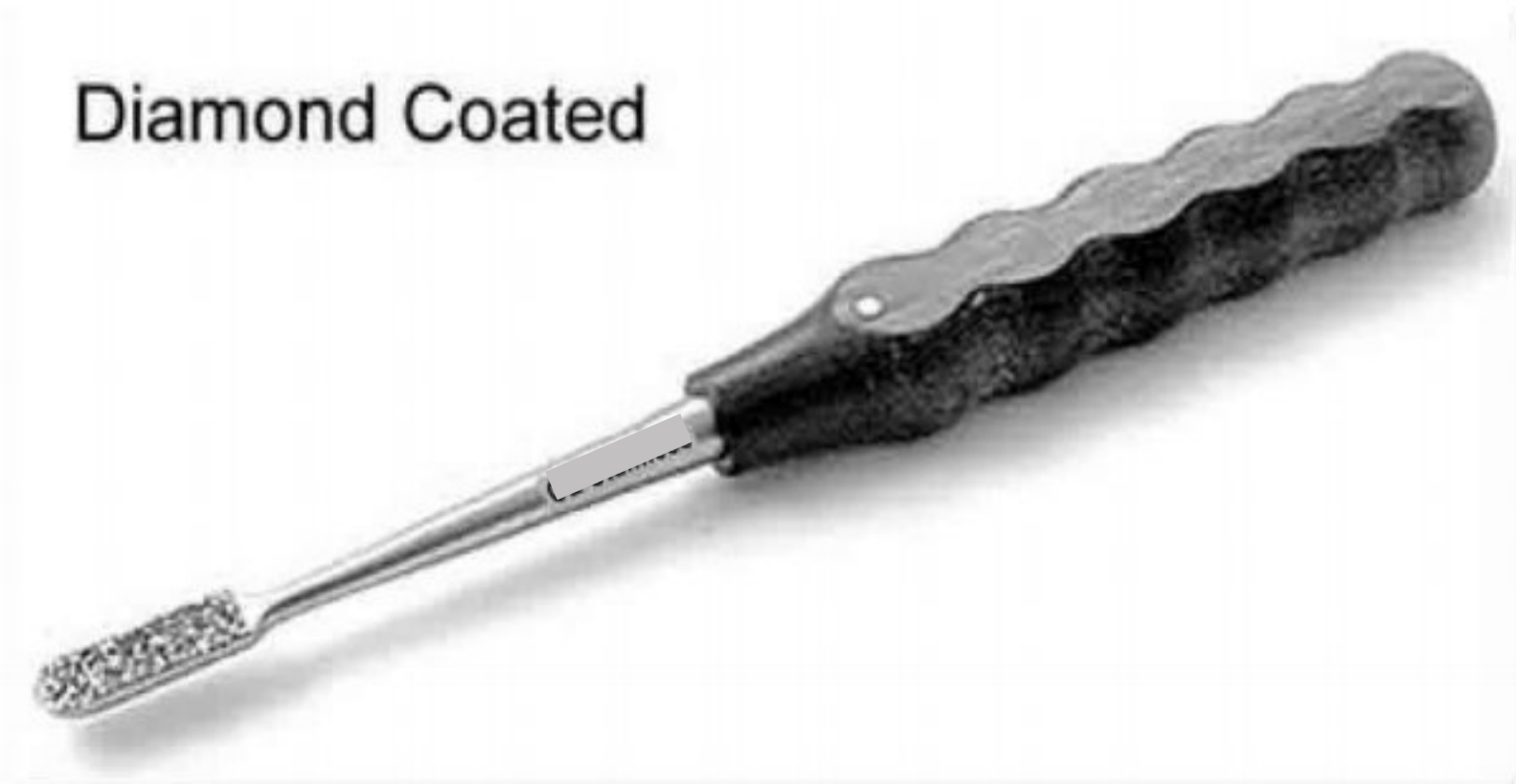

AJ-2236 Bone File 18 cm / 7"
Fibre Handle / STR Diamond Coated

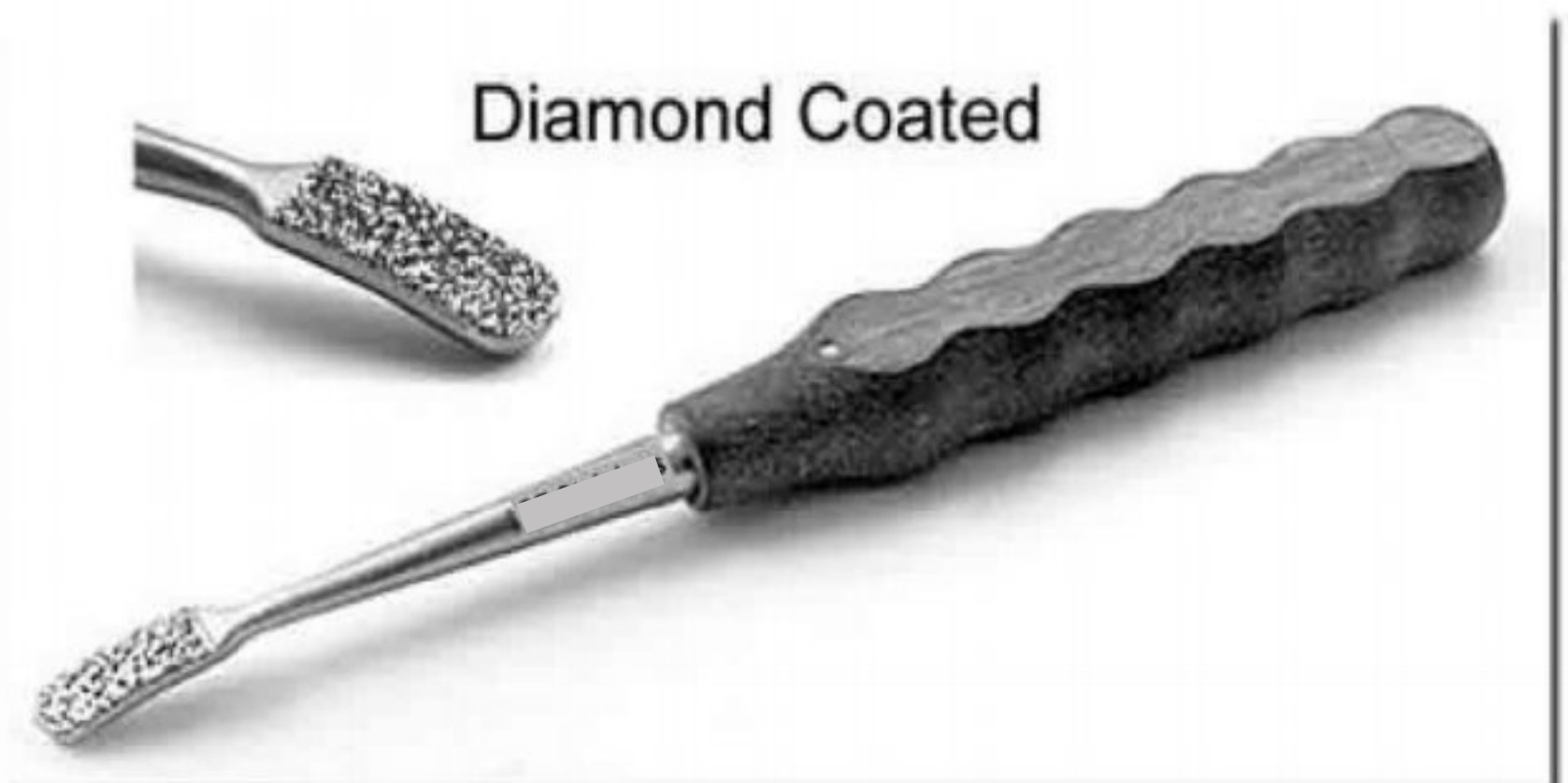

AJ-2237 Bone File 18 cm / 7"
Fibre Handle / CVD Diamond Coated

BONE FILES - RASPS

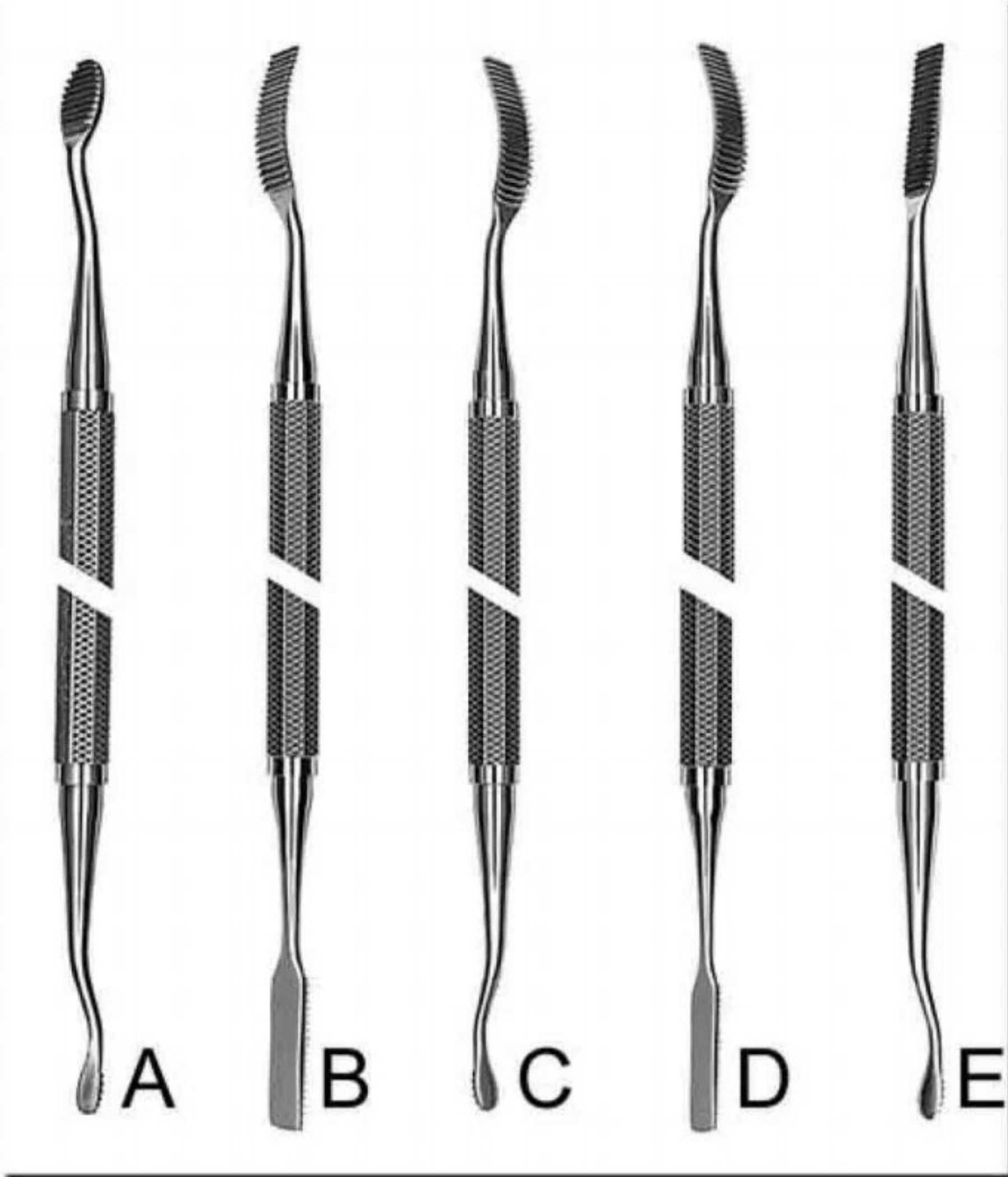

AJ-2238

A/B/C/D/E

Miller-Colburn Bone File 18 cm / 7" Downwards Cut

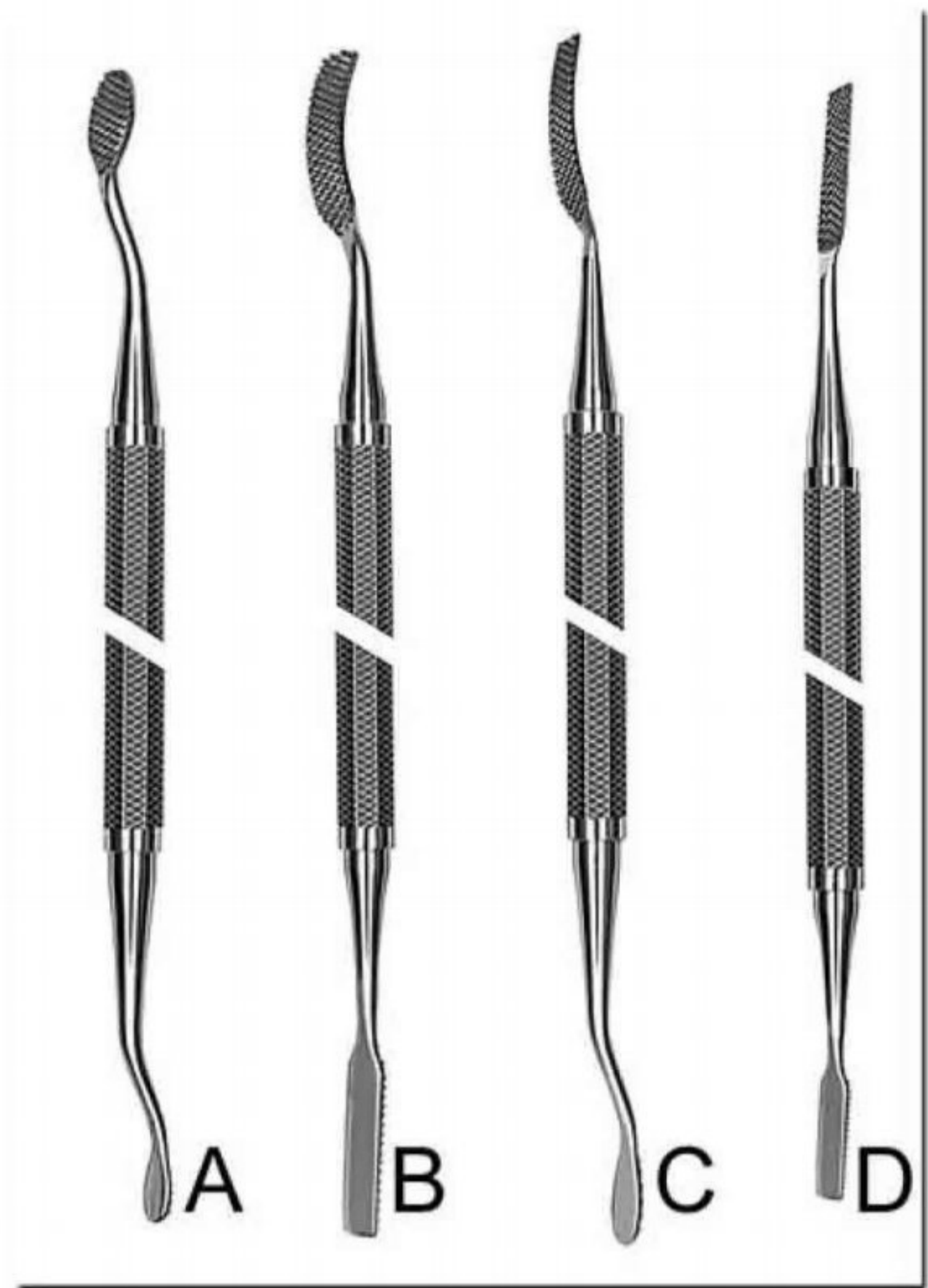

AJ-2239

A/B/C/D/

Miller-Colburn Bone File 18 cm / 7" Cross Cut



AJ-2240
Bone Rasp
21 cm / 8.5"
13mm
Fine/Coarse
Straight

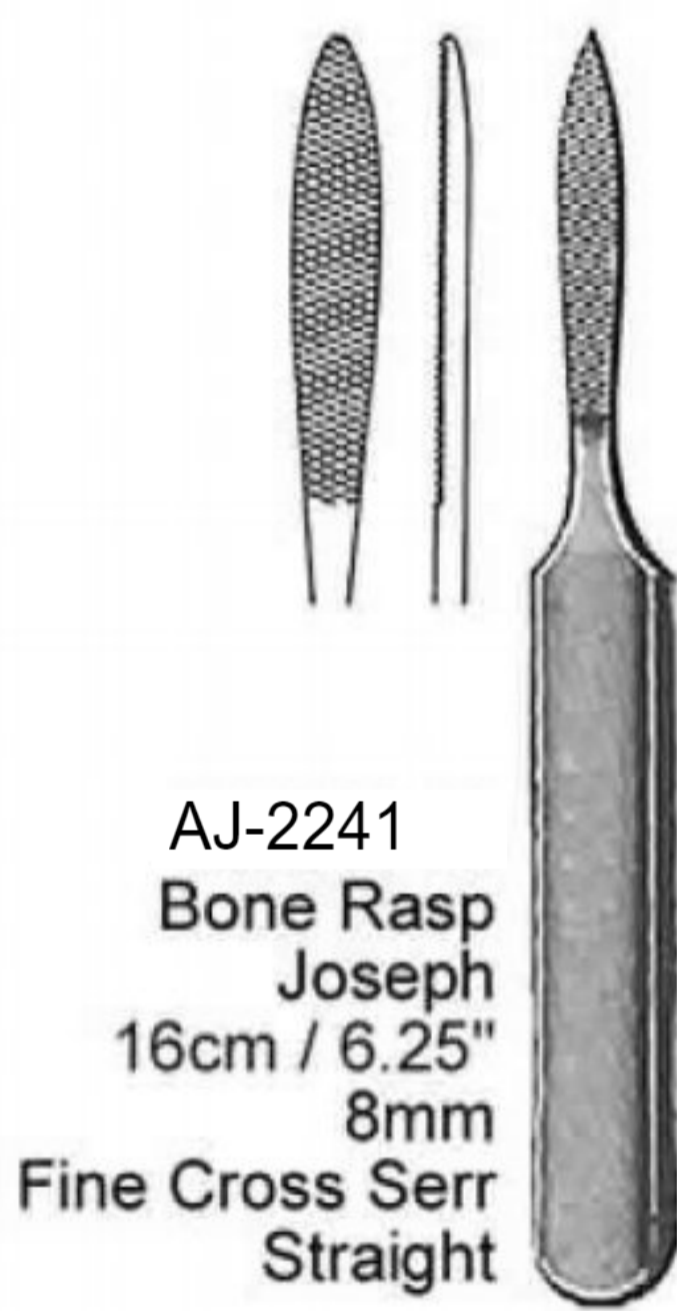

AJ-2241
Bone Rasp
Joseph
16cm / 6.25"
8mm
Fine Cross Serr
Straight



AJ-2242
Bone Rasp
Lewis
19cm / 7.5"
8mm
Straight

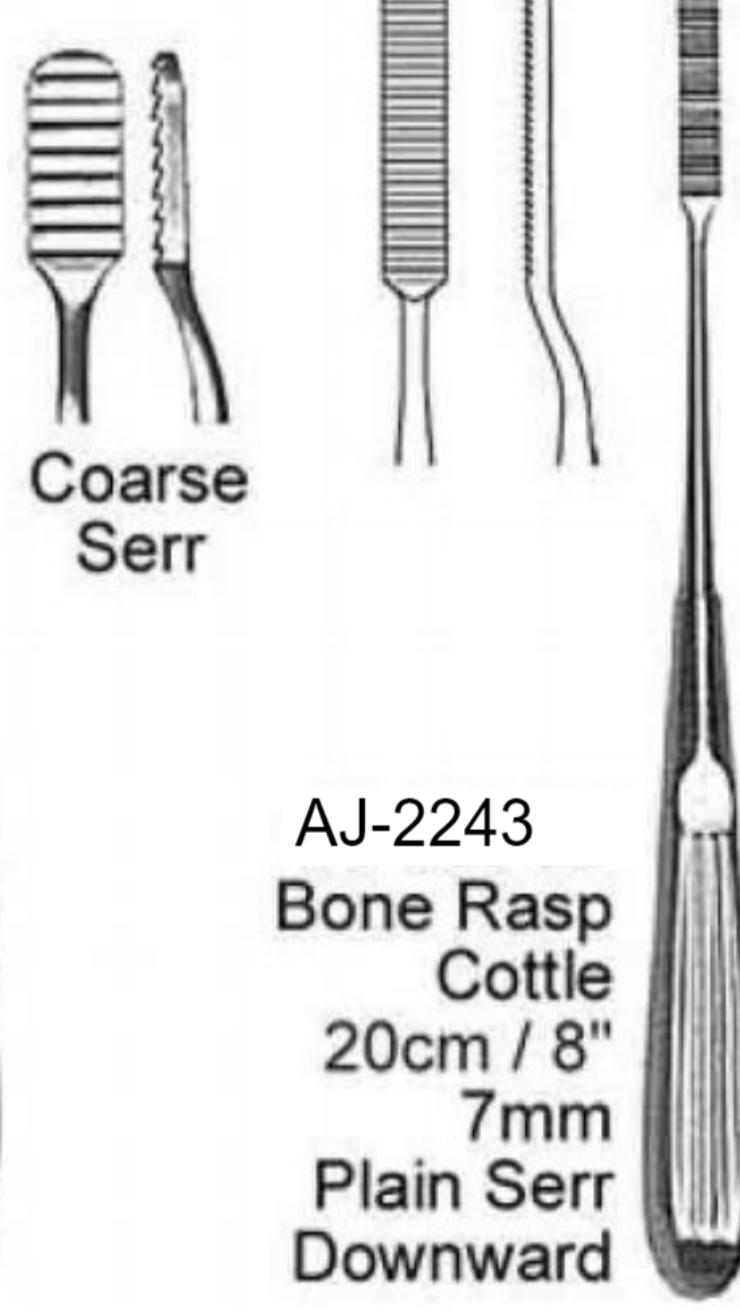

AJ-2243
Bone Rasp
Cottle
20cm / 8"
7mm
Plain Serr
Downward



AJ-2244
Bone Rasp
Maltz
18cm / 7"
9mm
Plain
Coarse Serr
Downward

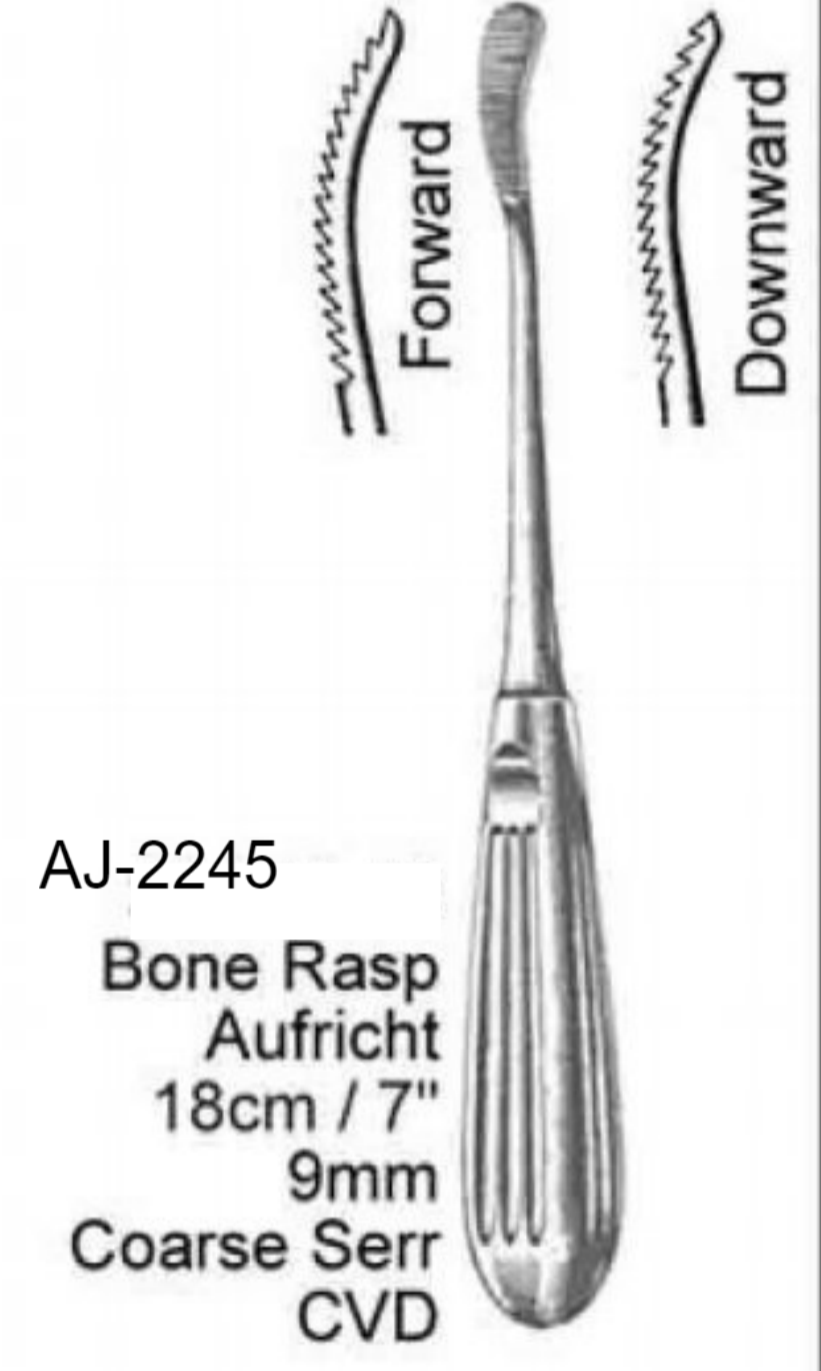

AJ-2245
Bone Rasp
Aufricht
18cm / 7"
9mm
Coarse Serr
CVD



AJ-2246
Bone Rasp
Fomon
21 cm / 8.5"
8mmX40mm
Coarse Serr
4 Sided
Flat / Covex Baldes



AJ-2247
Bone Rasp
Fomon
21 cm / 8.5"
8mmX40mm
Fine Serr
4 Sided
Flat / Covex Blades



AJ-2248
Bone Rasp
Kleinert Kurtz
21 cm / 8.5"
8mmX45mm
Fine/Coarse Serr
4 Sided
Flat / Covex Blades

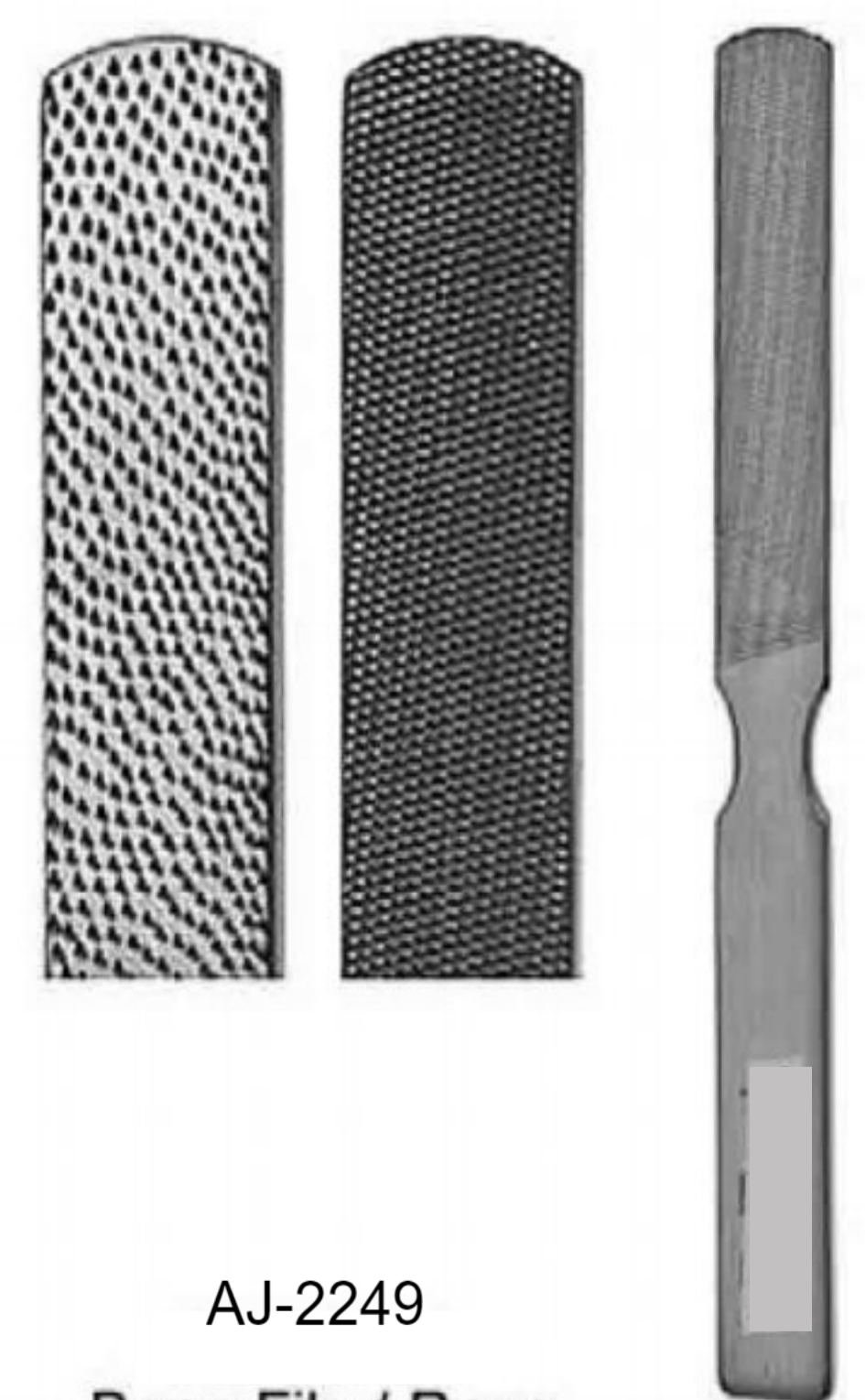

AJ-2249
Bone File / Rasp
21 cm / 8.5"
18mm
Fine / Coarse Serr

RETRACTORS - BONE LEVERS

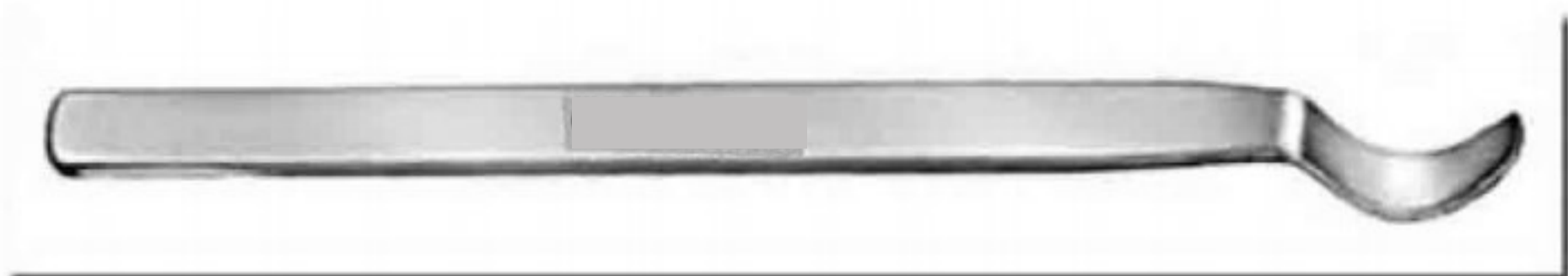

AJ-2250 Bone Lever
16 cm / 6 1/4"

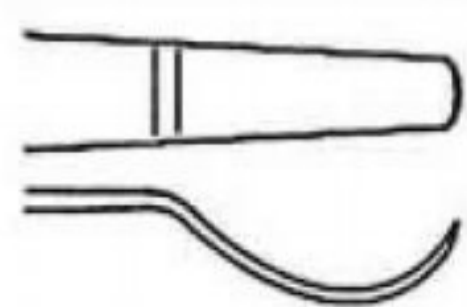

AJ-2252 Hohman, Mini Bone Lever
16 cm / 6 1/4" 14 mm tip

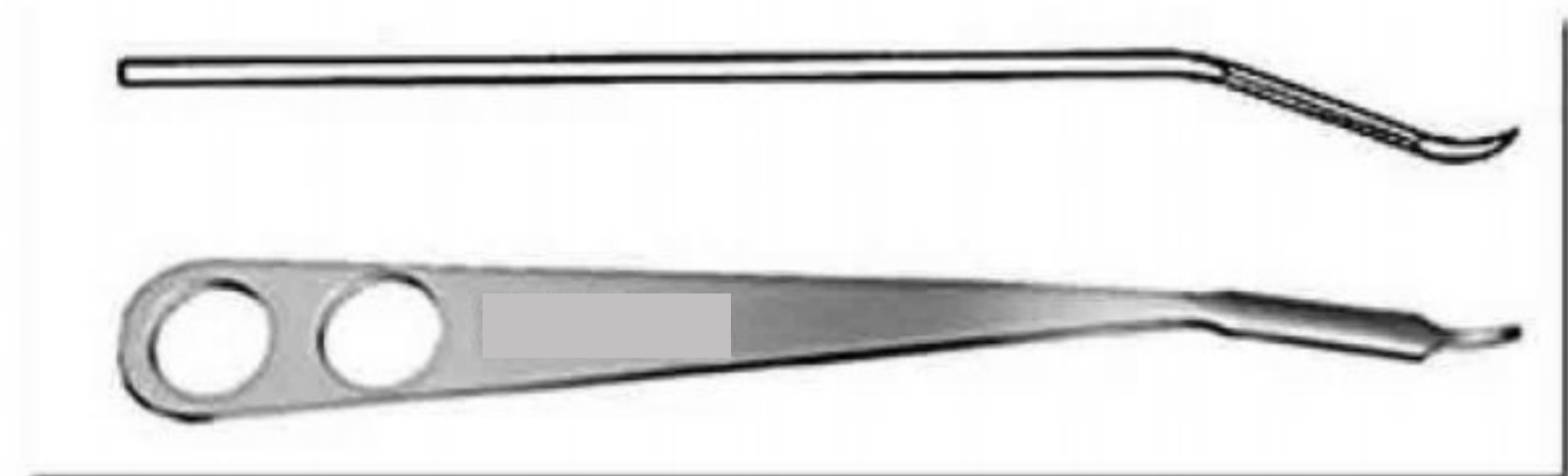
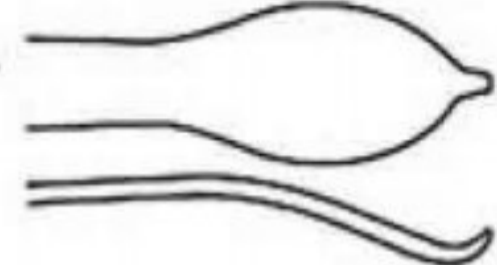

AJ-2255 Hohmann Bone Lever
22 cm / 8 3/4" 8 mm Tip narrow tip

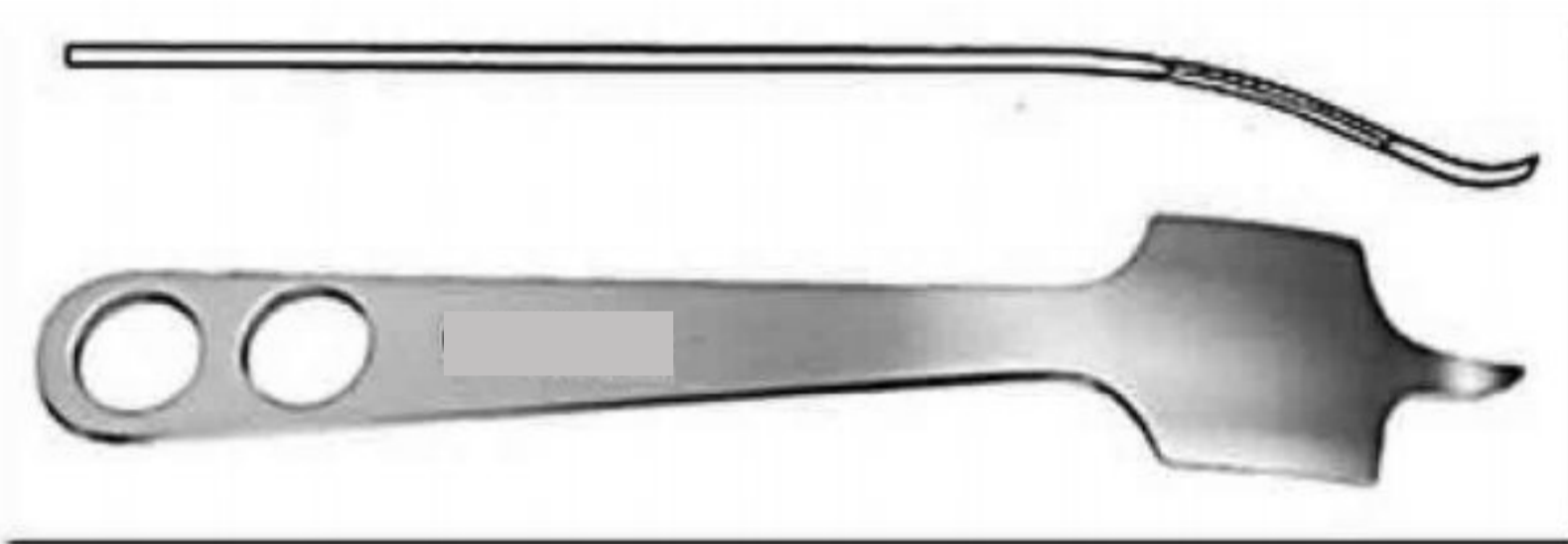

AJ-2257 Hohmann Bone Lever
23.5 cm / 9 1/4" 43 mm Tip narrow tip

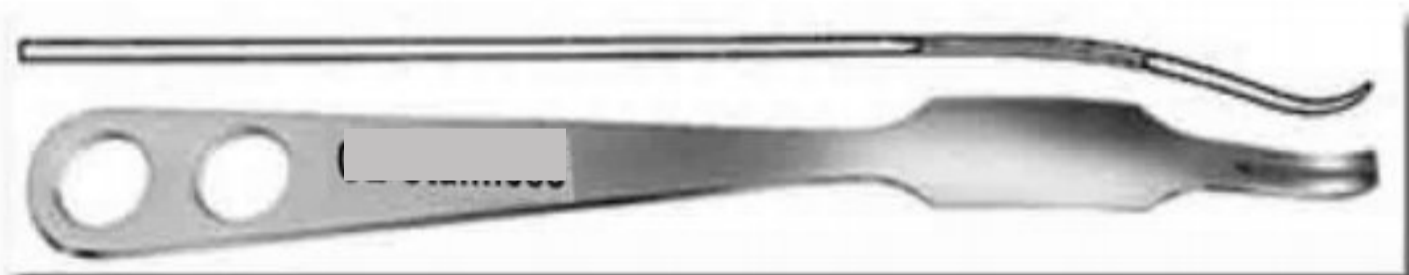

AJ-2260 Lange-Hohmann Bone Lever
25 cm / 9 3/4" 22mm Tip wide tip with groove



AJ-2261 Hohmann Bone Lever 27.5 cm / 10 3/4"
24mm Tip wide, round tip



Sizes Available
A: 75X30mm
B: 100X30mm

AJ-2266 A / B Taylor Spinal Retractor
16 cm/6 1/4" pointed end

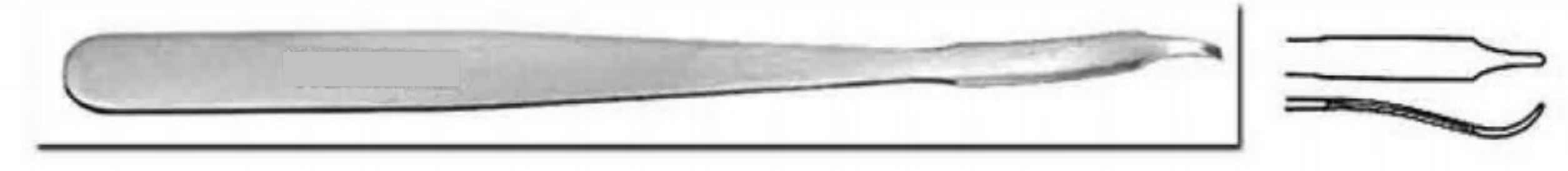

AJ-2251 Hohman, Mini Bone Lever 16 cm / 6 1/4" 6mm tip



AJ-2253 Hohman, Mini Bone Lever 16 cm / 6 1/4" 8 mm tip

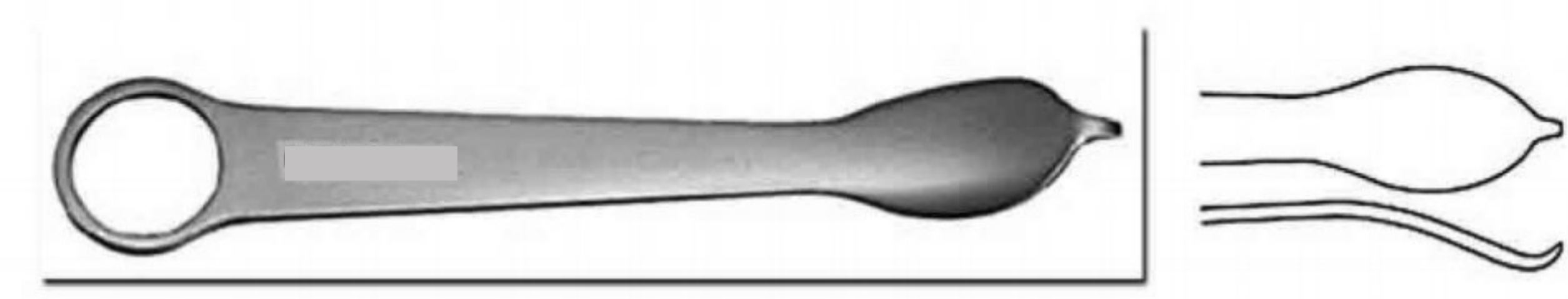

AJ-2254 Hohman, Mini Bone Lever 12 cm / 4 3/4" 14 mm tip

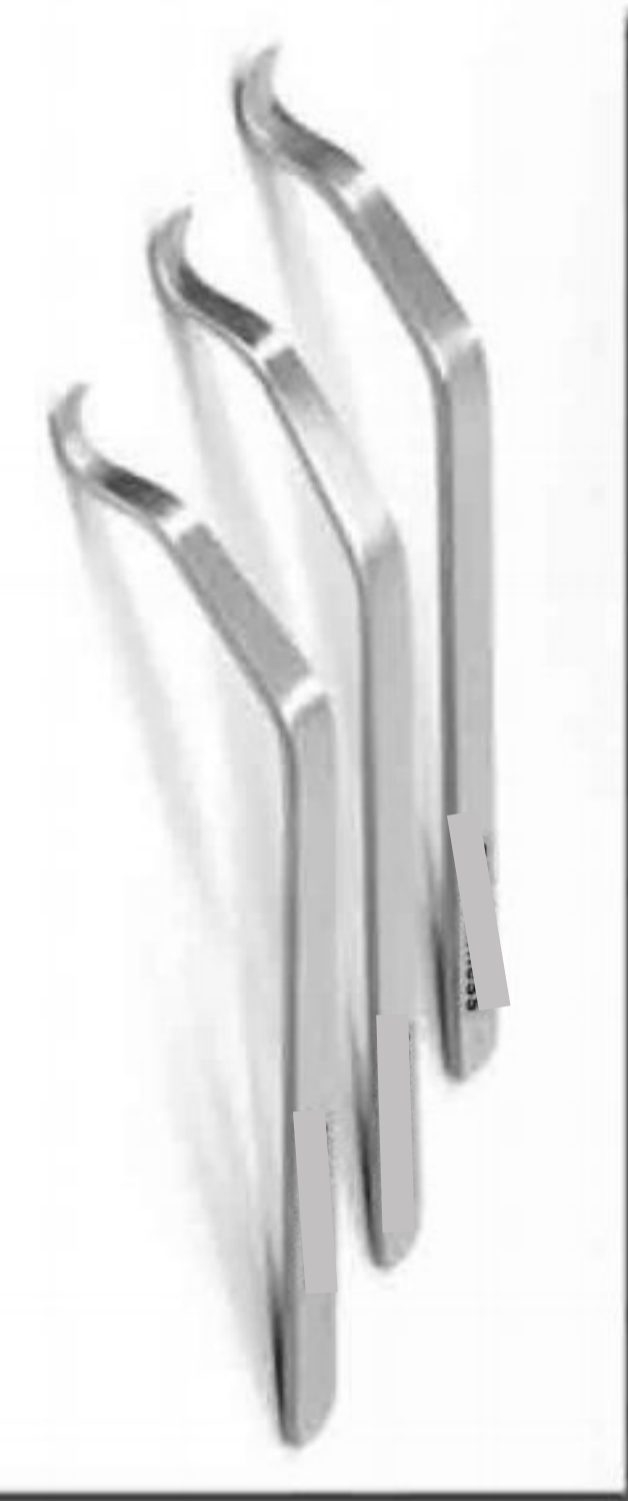

AJ-2258 Hohmann Bone Lever
13cm/5" A:3mm B:5mm C:7mm

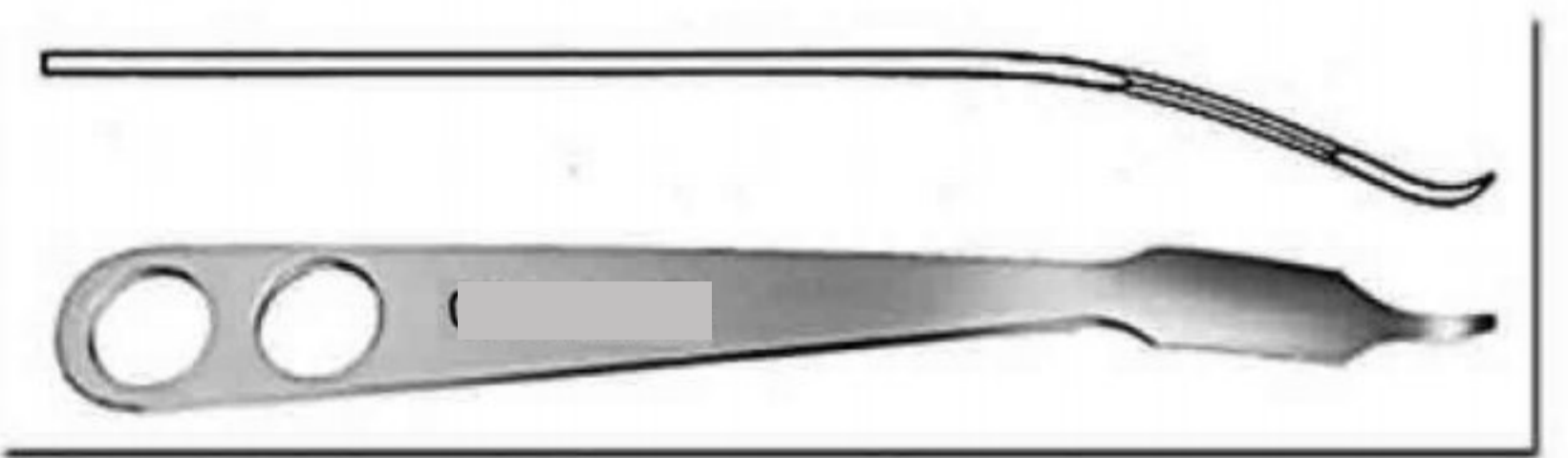

AJ-2256 Hohmann Bone Lever
23.5 cm / 9 1/4" 18 mm Tip narrow tip

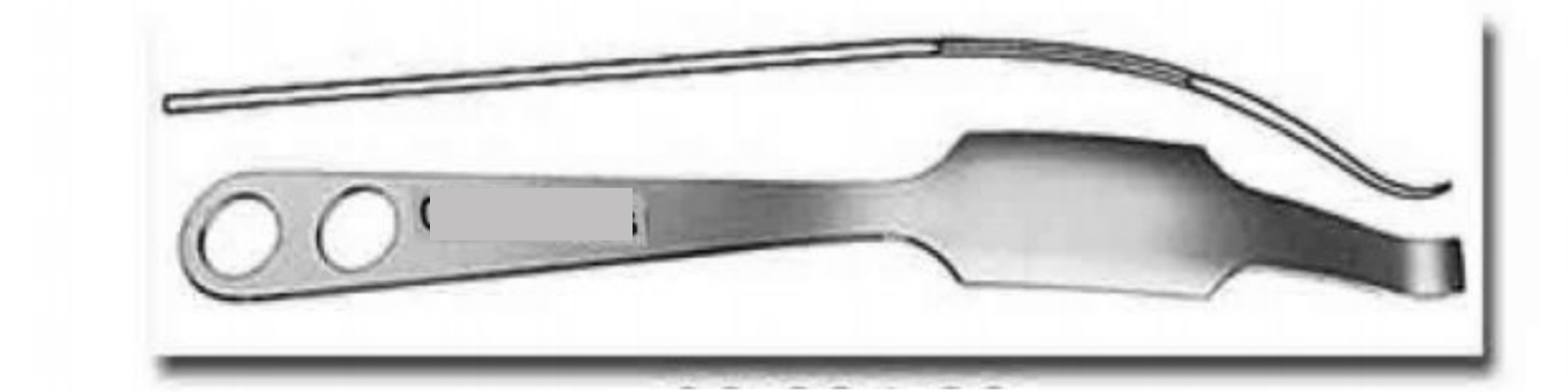

AJ-2259 Hohmann Bone Lever 29 cm / 11 1/2"
35mm Tip wide tip

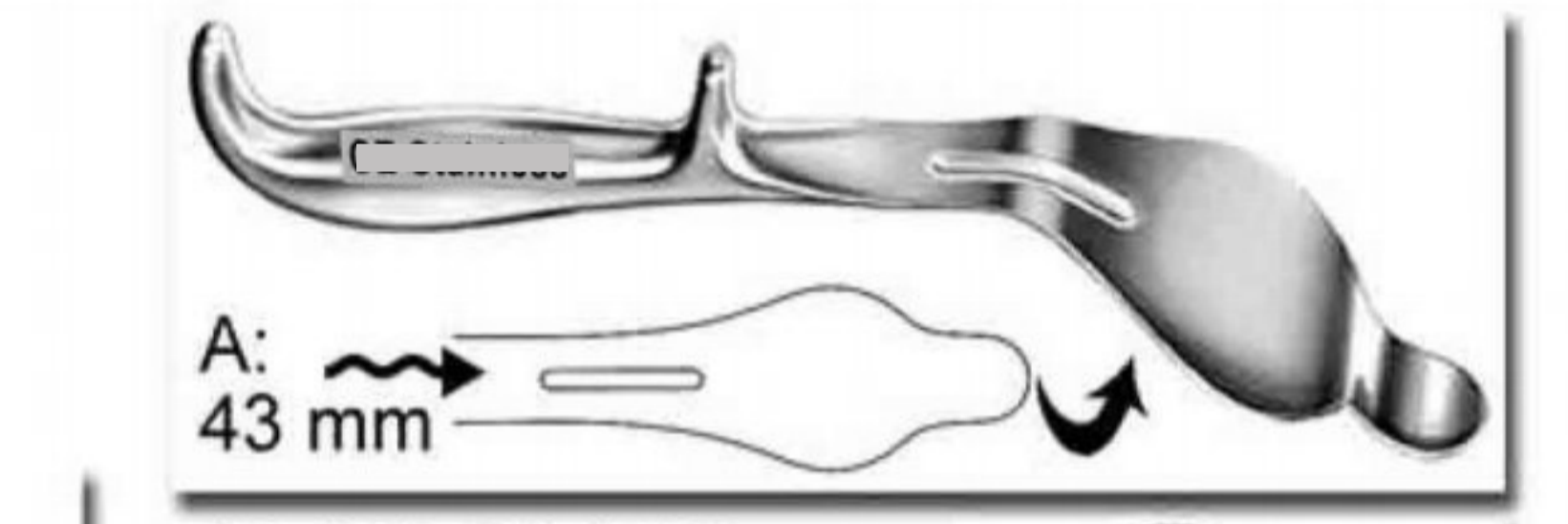

AJ-2263 Bennett Bone Lever
24 cm / 9 1/2" B: 60 mm



AJ-2265 Blount Knee Retractor
26.5 cm / 10 1/2" blunt



AJ-2264 Hohmann Bone Lever
23.5 cm / 9 1/4" 43mm Tip narrow tip

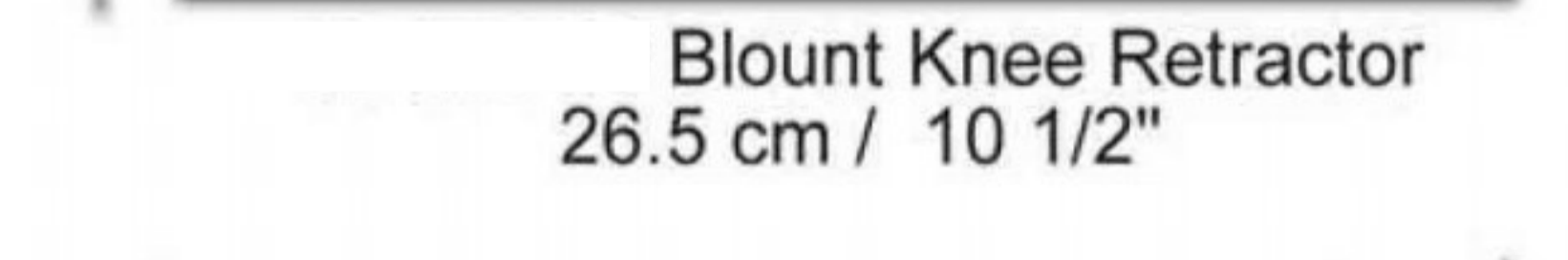

Blount Knee Retractor
26.5 cm / 10 1/2"



AJ-2266 Hohmann Bone Lever 25.5 cm / 10"
22mm Tip wide tip

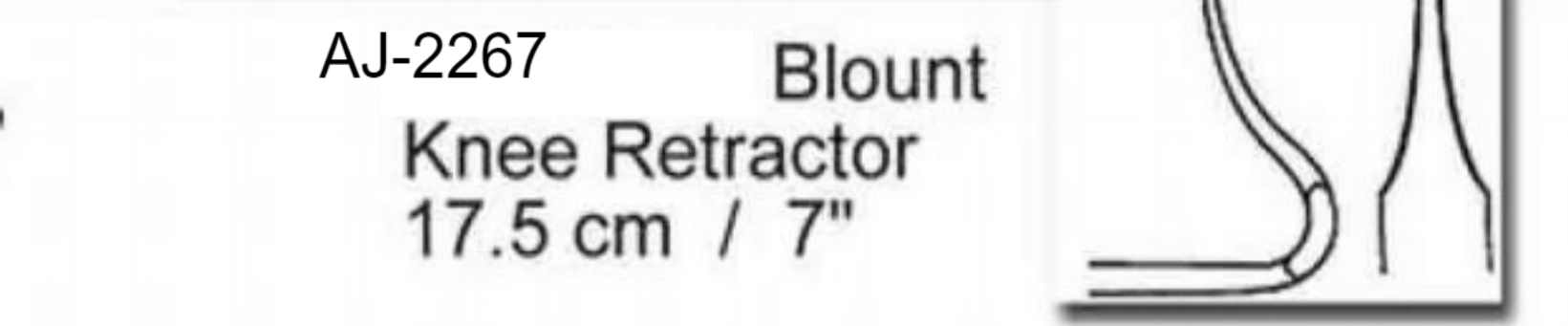

AJ-2267 Blount Knee Retractor
17.5 cm / 7"

RETRACTORS - BONE LEVERS

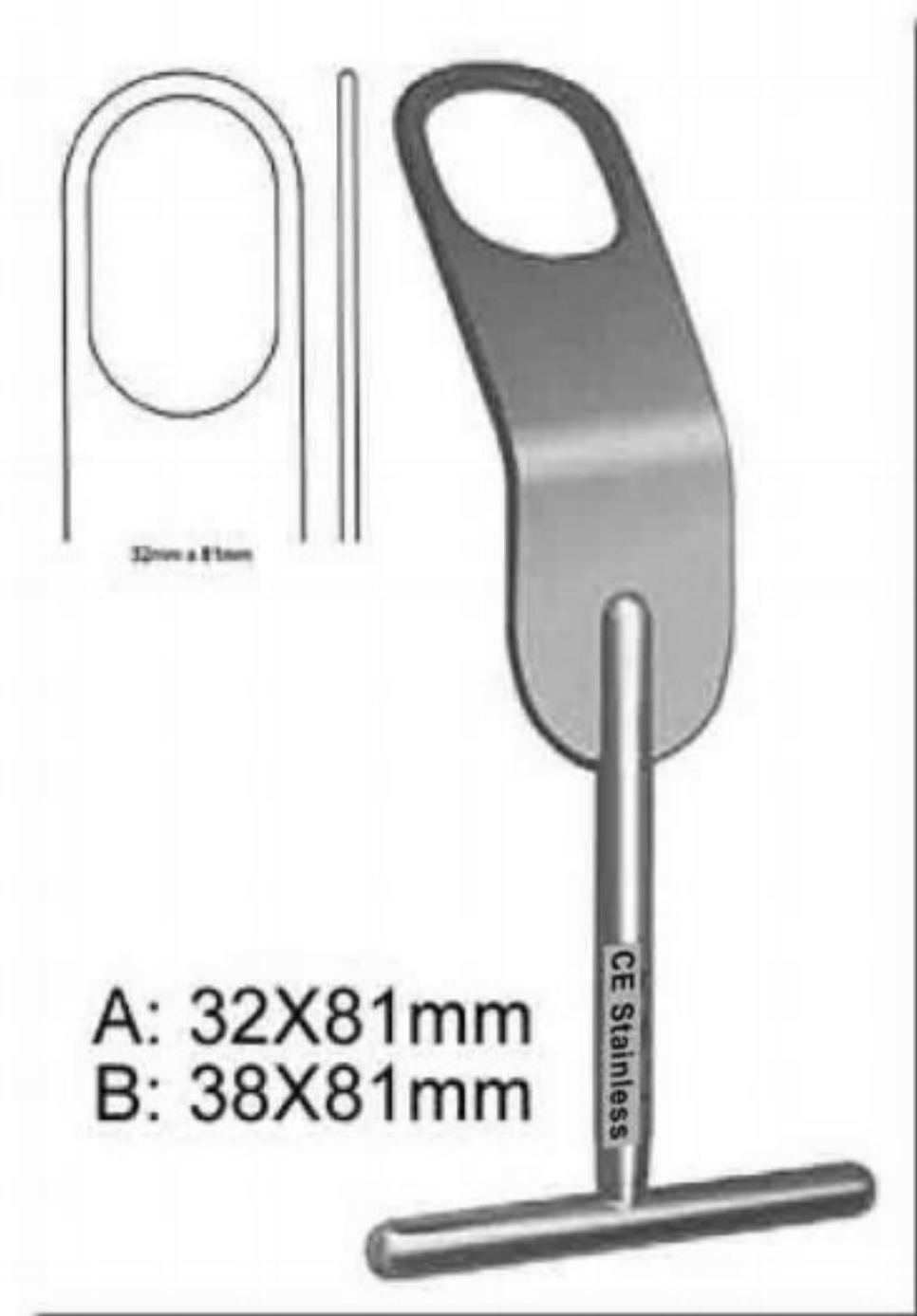

AJ-2268 Fukuda Retractor
19 cm / 7 1/2" T Handle



30-336-28 Browne - Deltoid Retractor
28 cm / 11" T Handle w/ Ring



AJ-2269 Humeral Head Retractor
18 cm / 7" Strong Curved

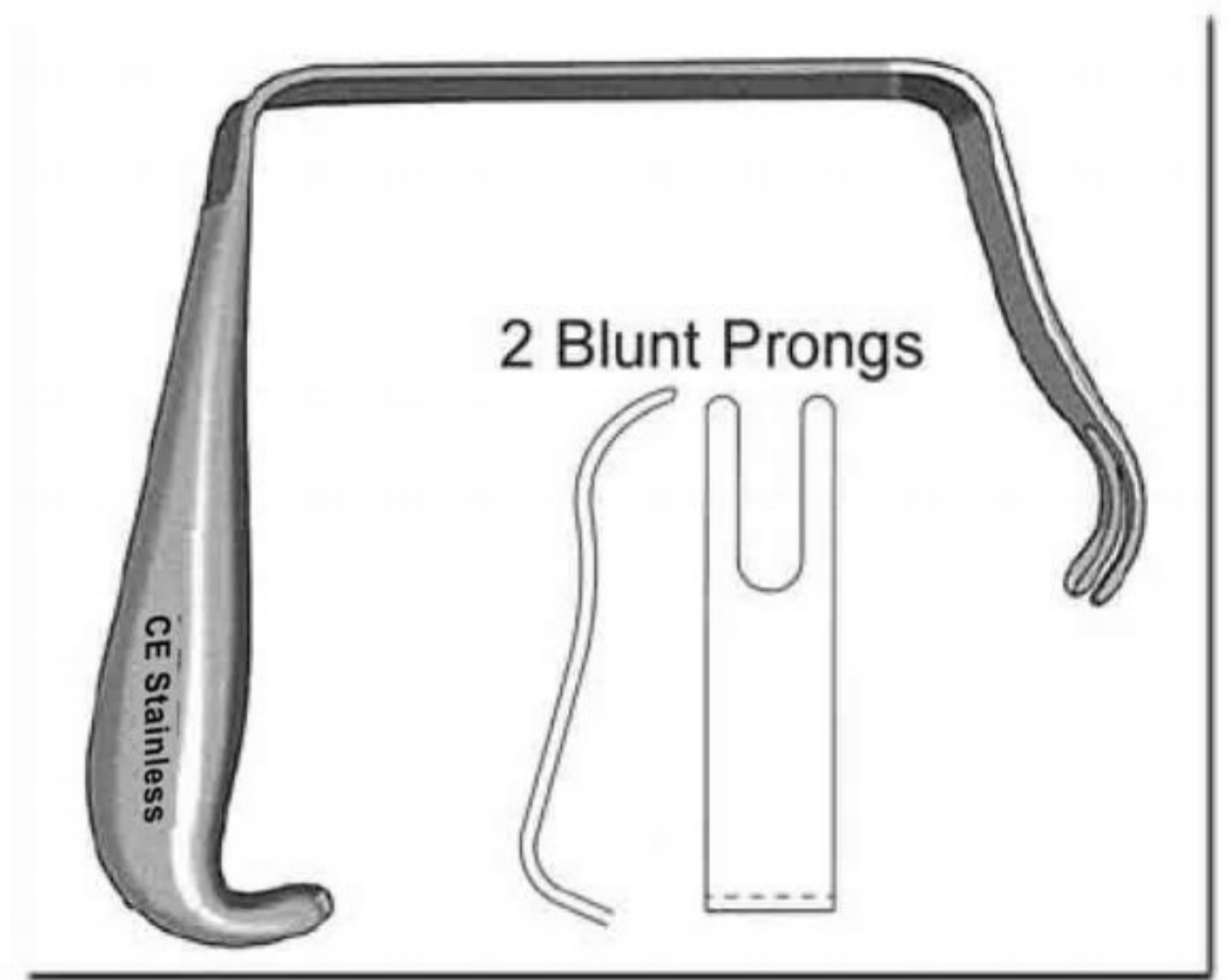

AJ-2270 Bristow / Bankart
Humeral Retractor
18 cm / 7"



AJ-2271 Capsule Retractor
25 cm / 10"

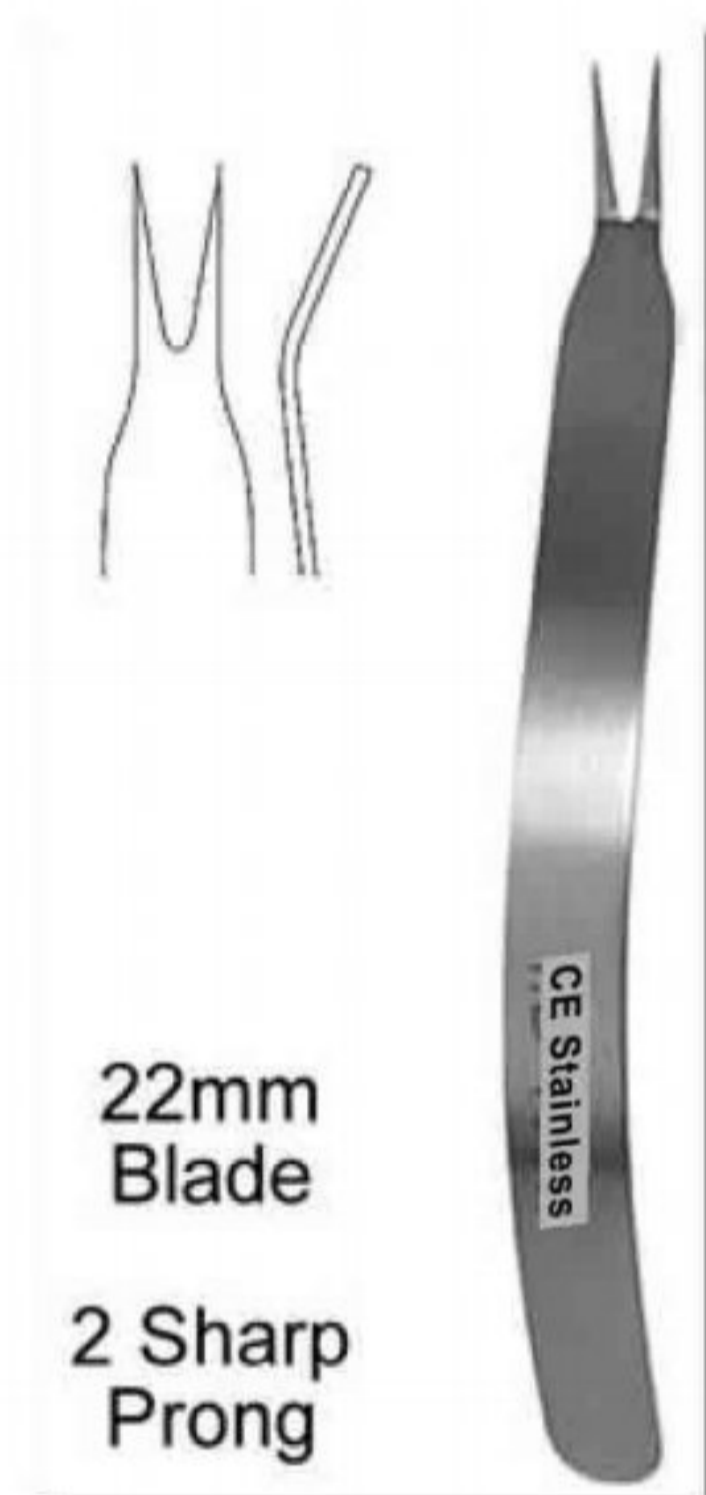

AJ-2272 Capsule Retractor
25 cm / 10"

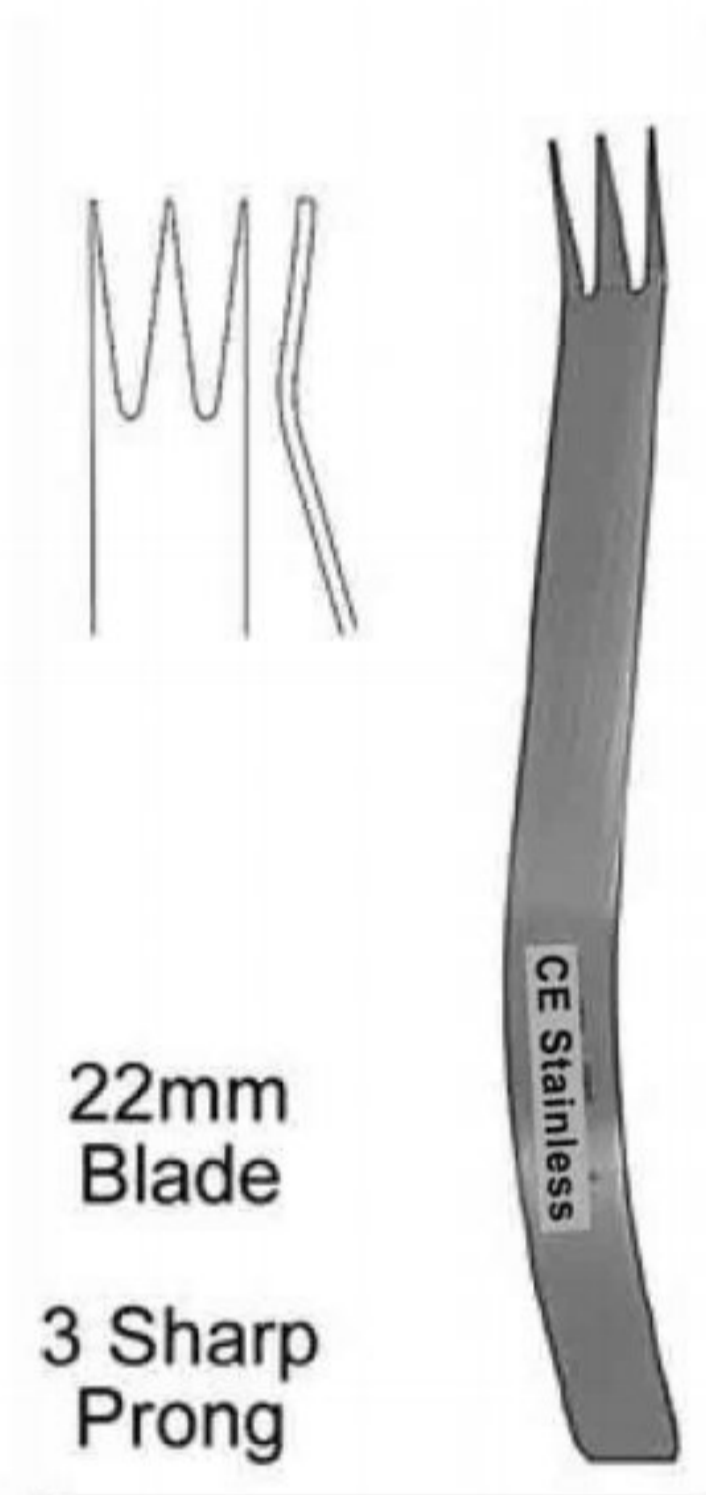

AJ-2273 Capsule Retractor
25 cm / 10"

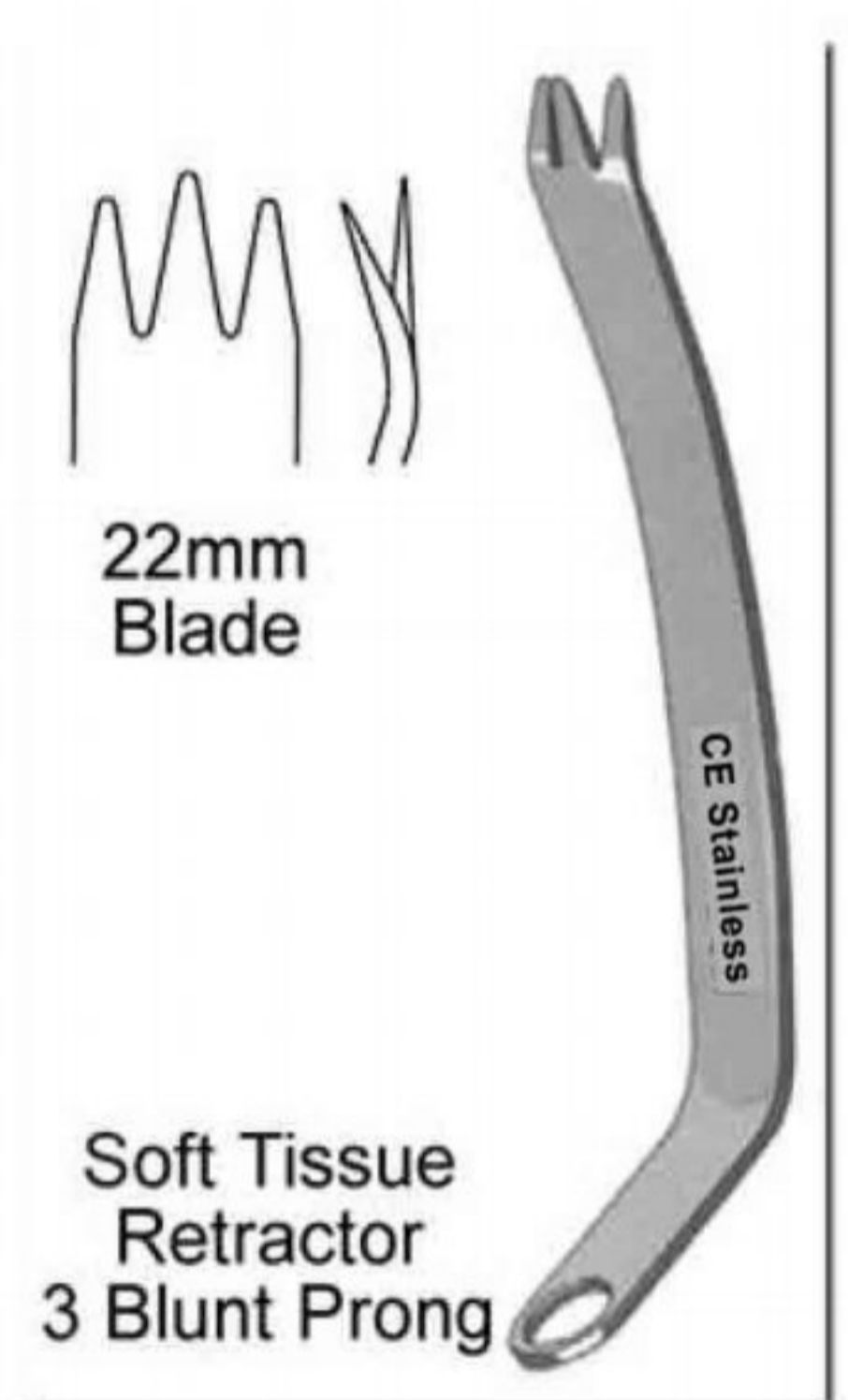

AJ-2274 Bristow/Bankart
Soft Tissue Retractor
19 cm / 7 1/2"



AJ-2275 Blade Retractor
19 cm / 7 1/2"

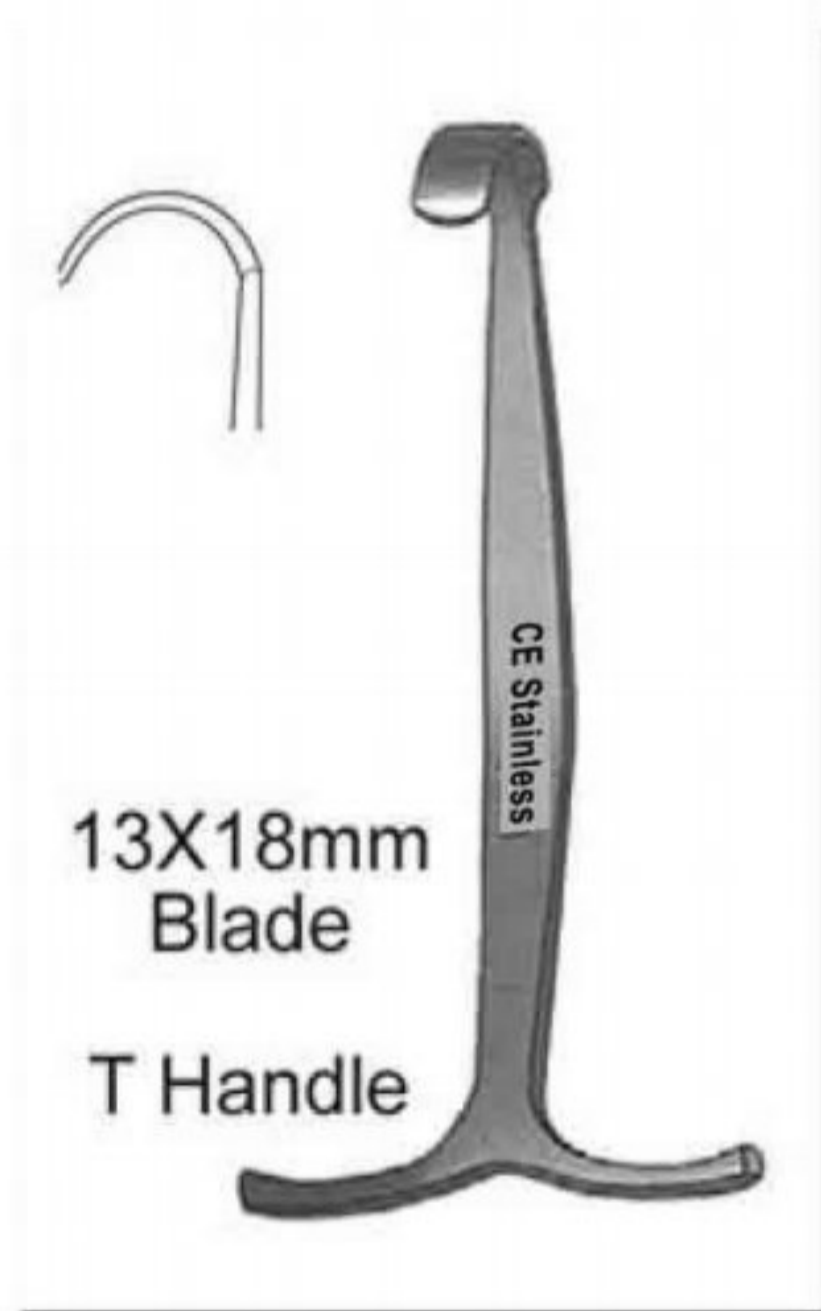

AJ-2276 Smillie Retractor
13cm / 5"



AJ-2277 Smillie Retractor
14cm / 5 1/2"

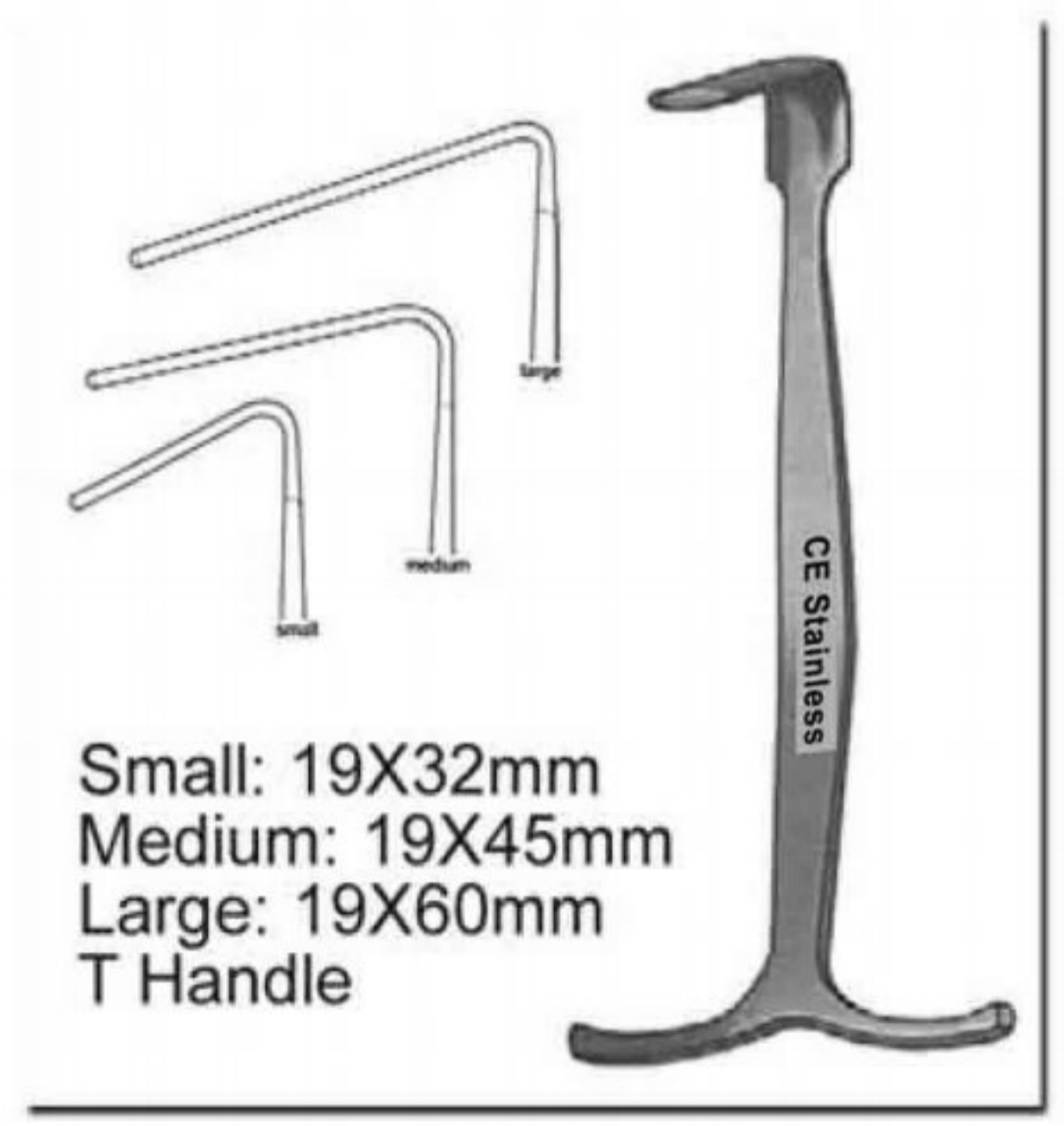

AJ-2278 Smillie Retractor
Angled Blade 14cm / 5 1/2"



AJ-2279 Z Knee Retractor
15 cm / 6"

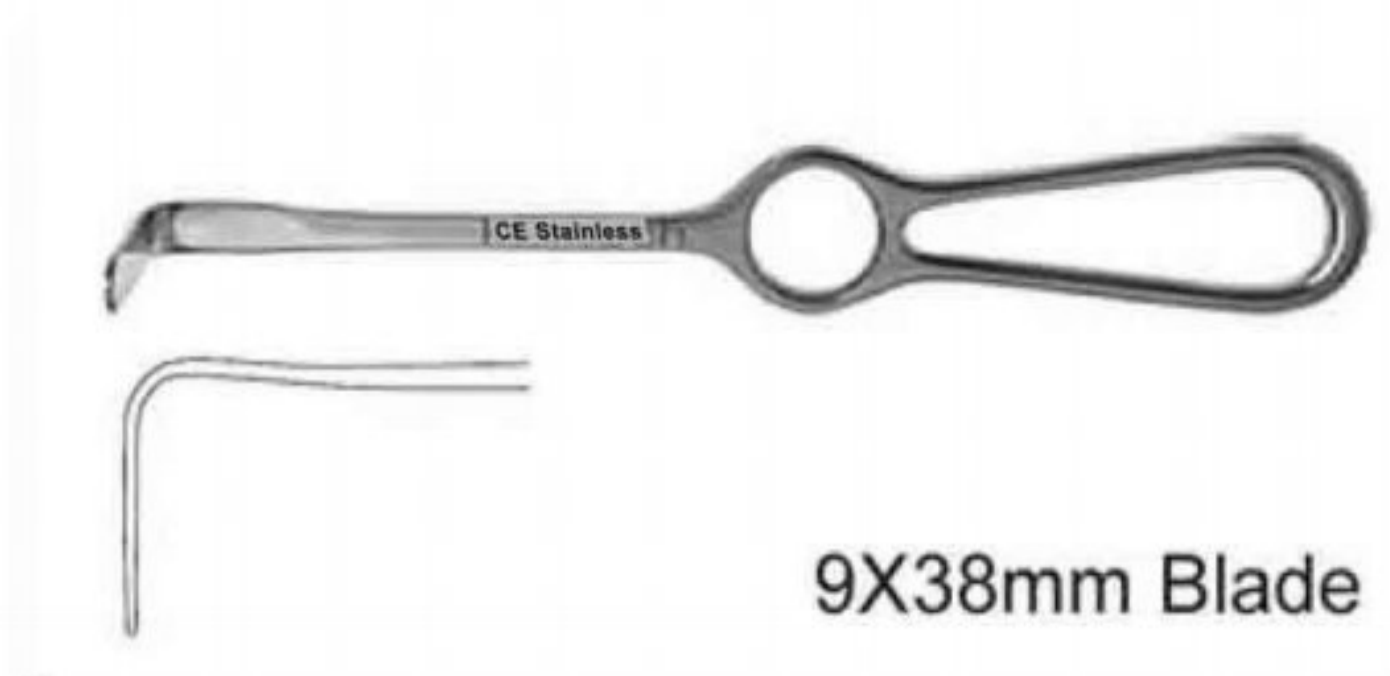

AJ-2280 Knee Retractor
22 cm / 8 1/2" Ring Handle

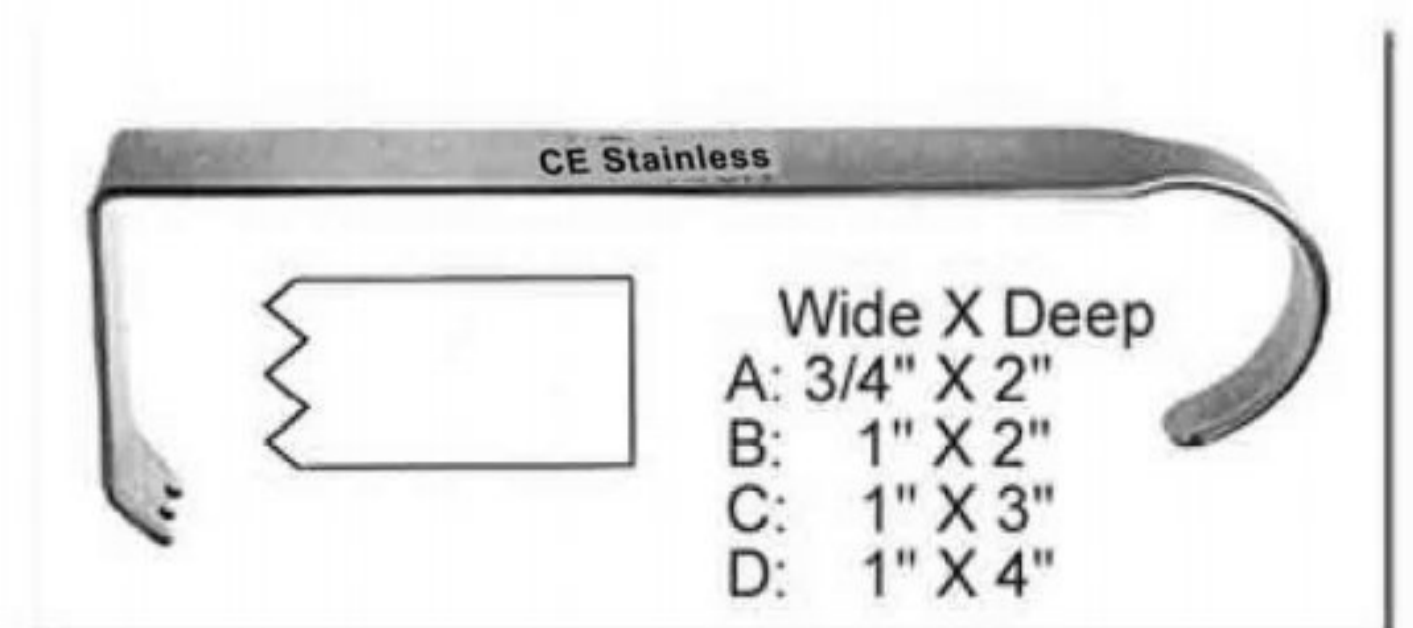

AJ-2281 Hibbs Retractor
24 cm / 9 1/2" Sharp Teeth

RETRACTORS - BONE LEVERS

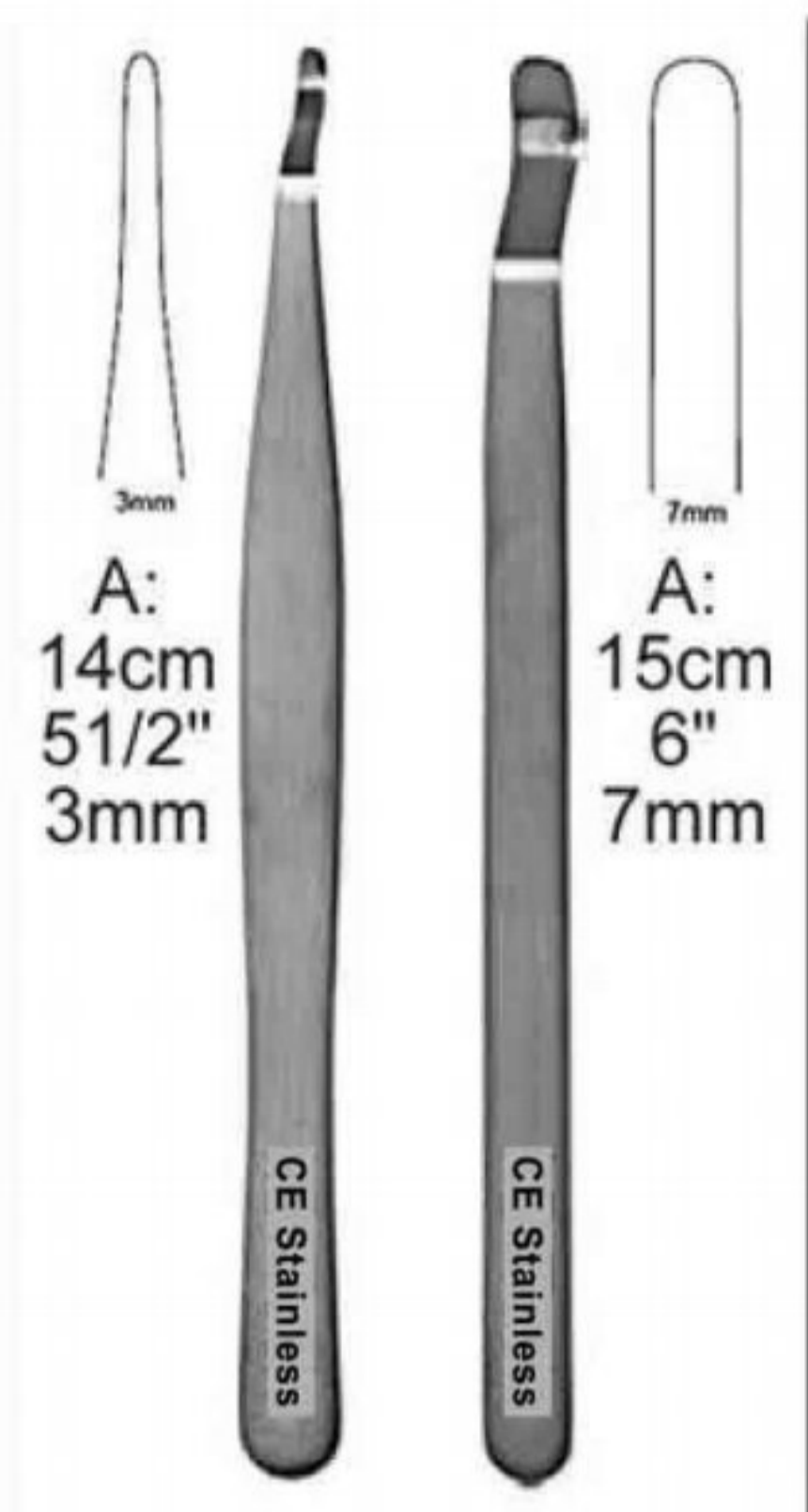

AJ-2282
Hayes Retractor

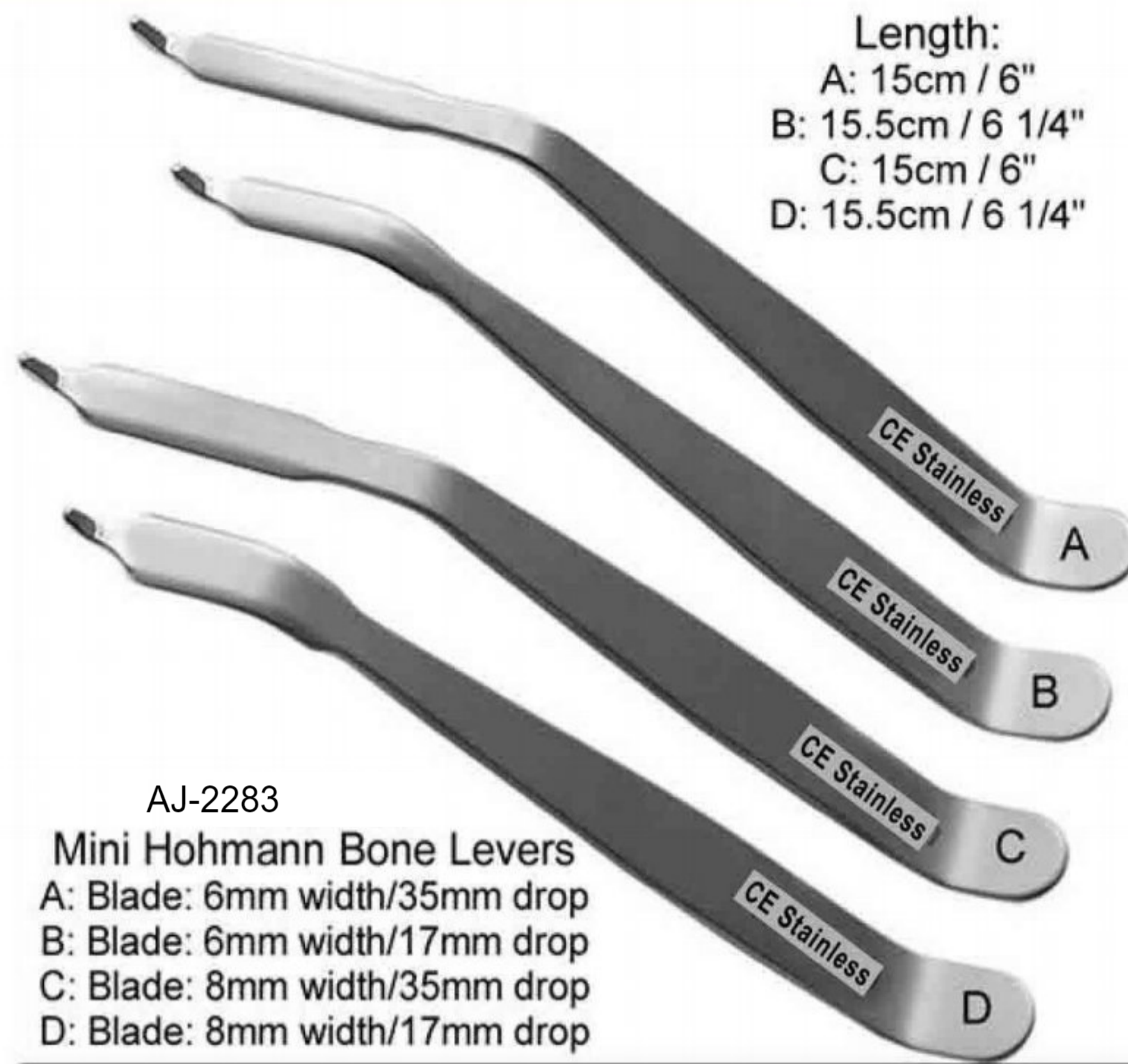

AJ-2283
Mini Hohmann Bone Levers
A: Blade: 6mm width/35mm drop
B: Blade: 6mm width/17mm drop
C: Blade: 8mm width/35mm drop
D: Blade: 8mm width/17mm drop

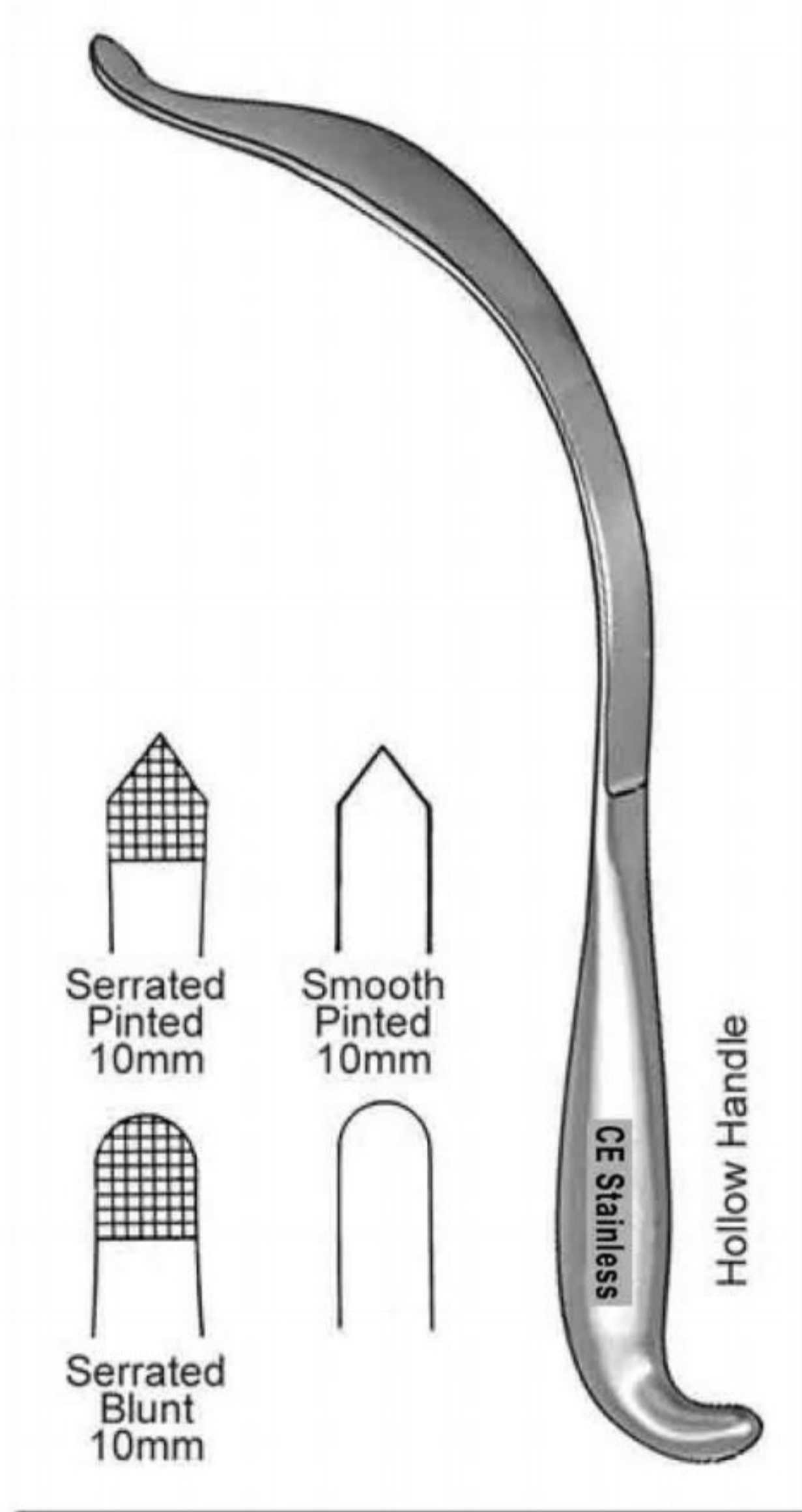
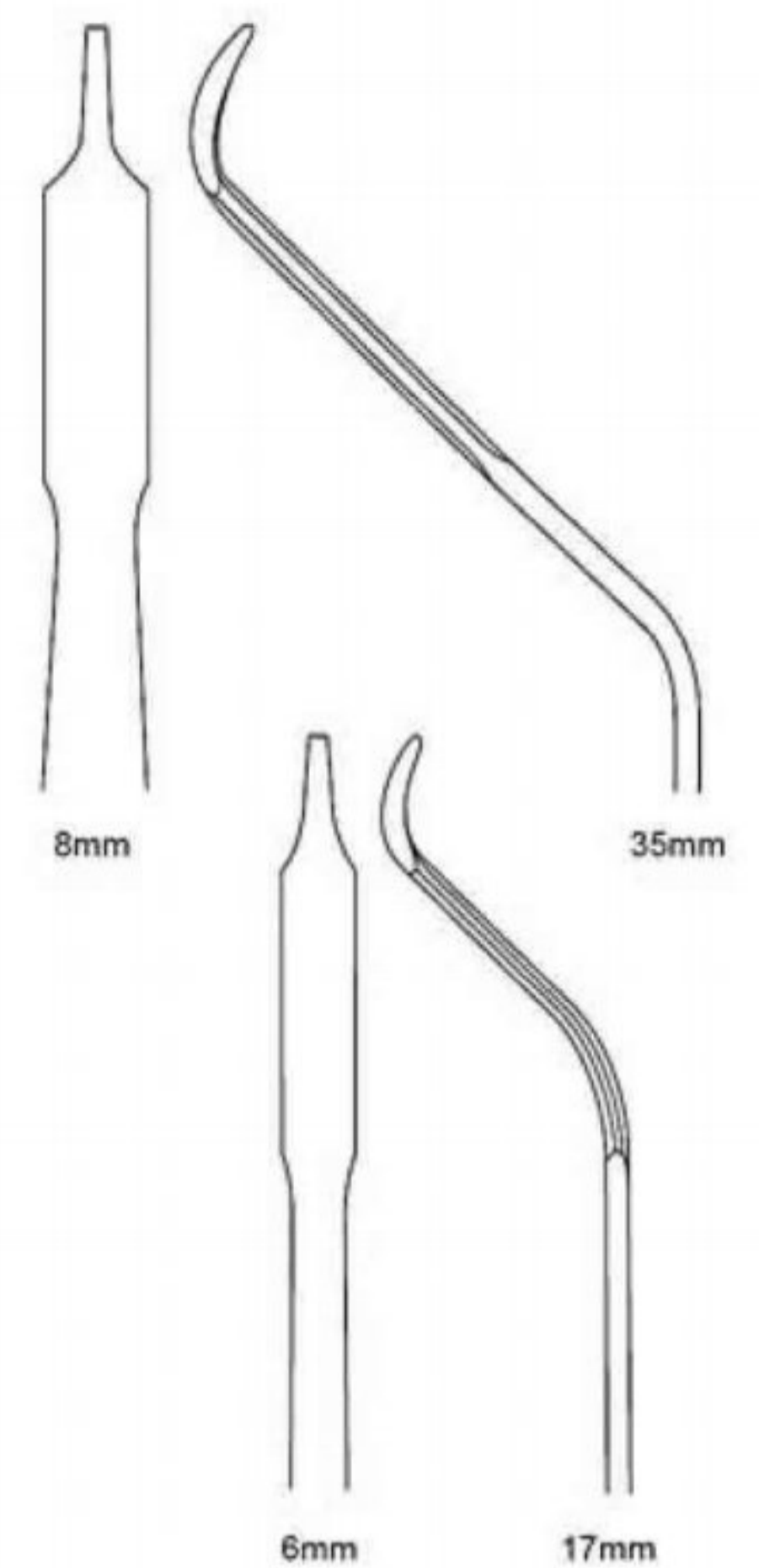

AJ-2284
Aufranc Cobra Retractor
A: 26cm / 10 1/2"

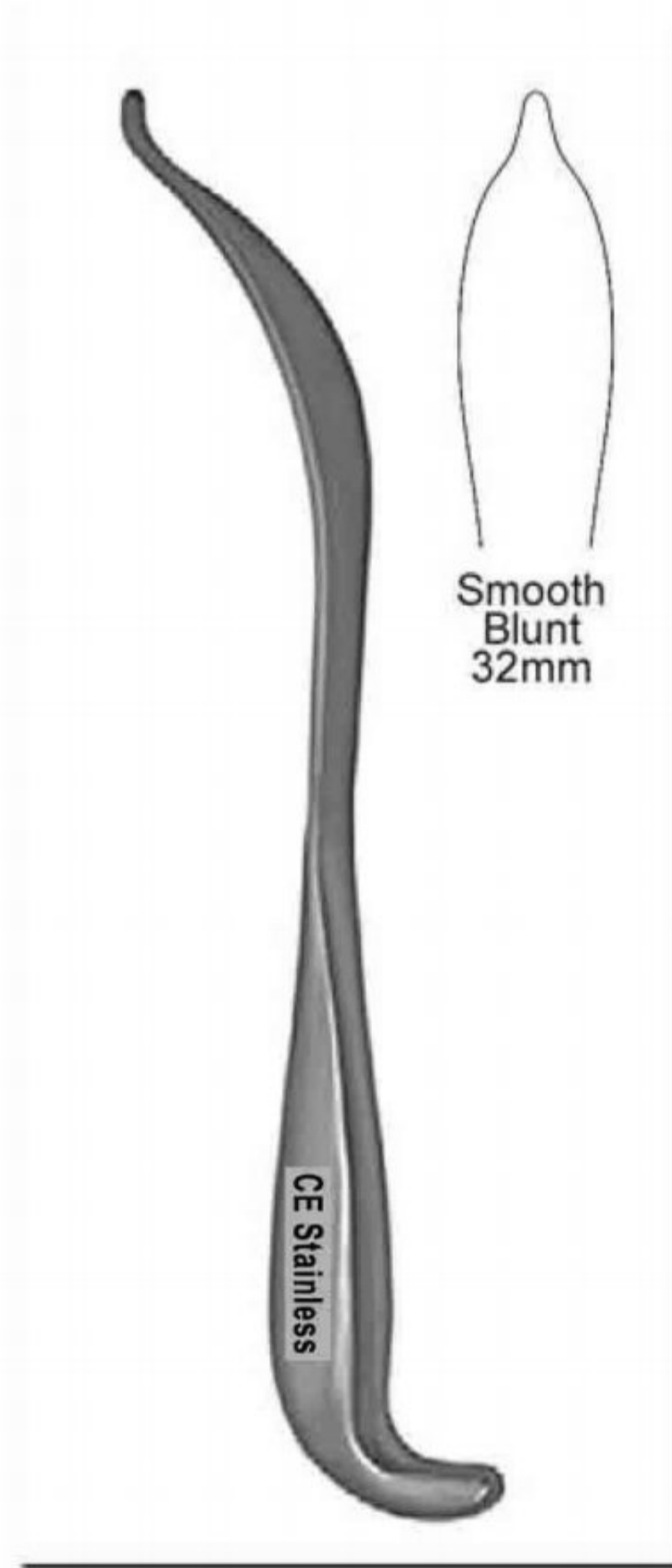

AJ-2285
Aufranc Cobra Retractor
A: 27.5cm / 11"

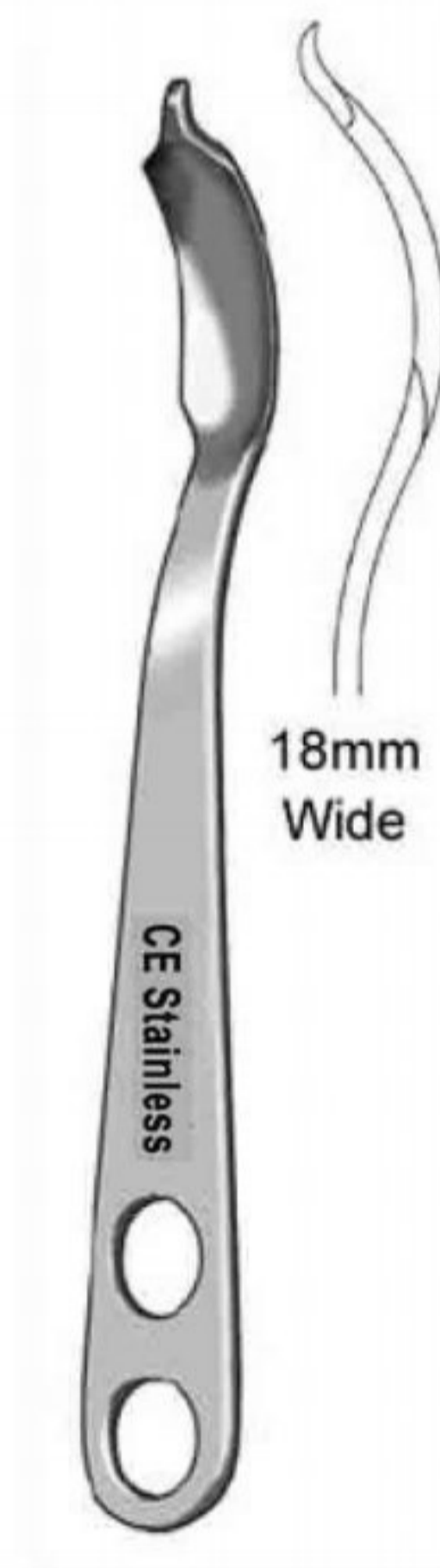

AJ-2286
Humeral Head Retractor
23cm / 9"

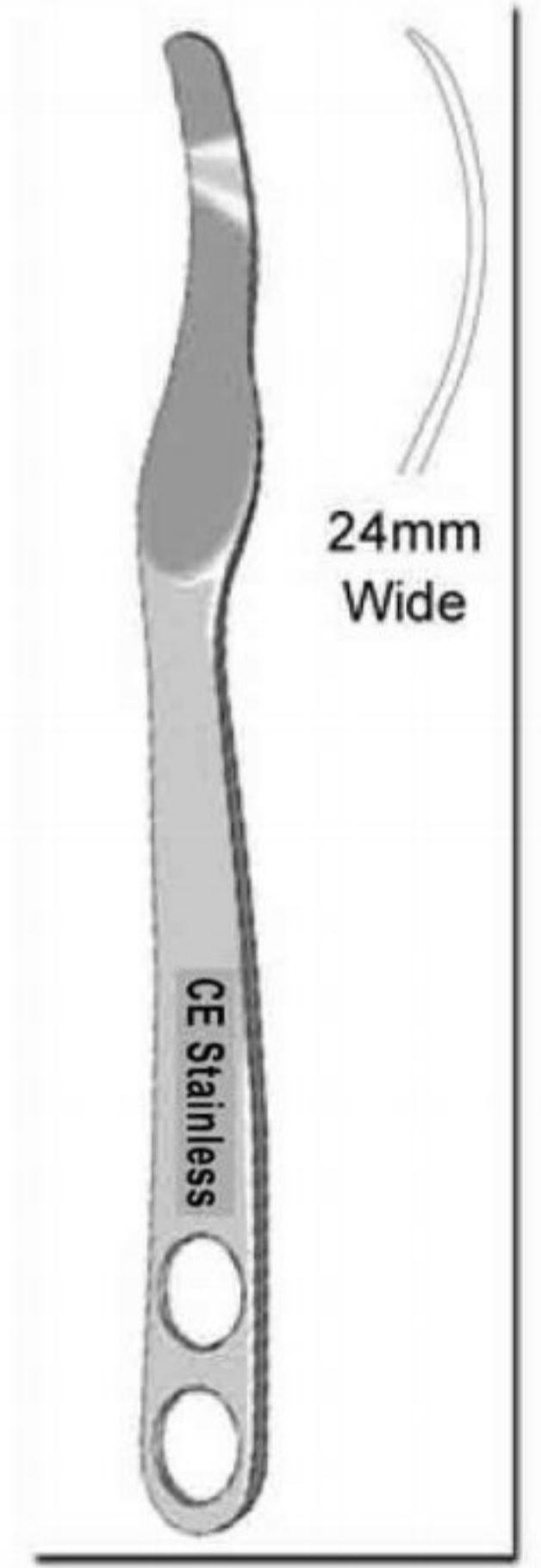

AJ-2287
Pelvic Retractor
Single Prong
A: 26cm / 10 1/2"



AJ-2288
Murphy Bone Skid
30cm / 12"



AJ-2289
Ribbon Retractor Malleable
30cm / 12"

A: 6" X 6mm
B: 6" X 12mm
C: 6" X 16mm
D: 6" X 19mm
E: 7 1/2" X 25mm

F: 8" X 6mm
G: 8" X 10mm
H: 8" X 12mm
I: 8" X 16mm
J: 8" X 19mm

K: 13" X 19mm
L: 13" X 30mm
M: 13" X 38mm
N: 13" X 45mm
O: 13" X 50mm
P: 13" X 65mm
Q: 13" X 75mm

Sizes Available

RETRACTORS - BONE LEVERS

AJ-2290
St. Mark's Pelvic Retractor
Angled Blade

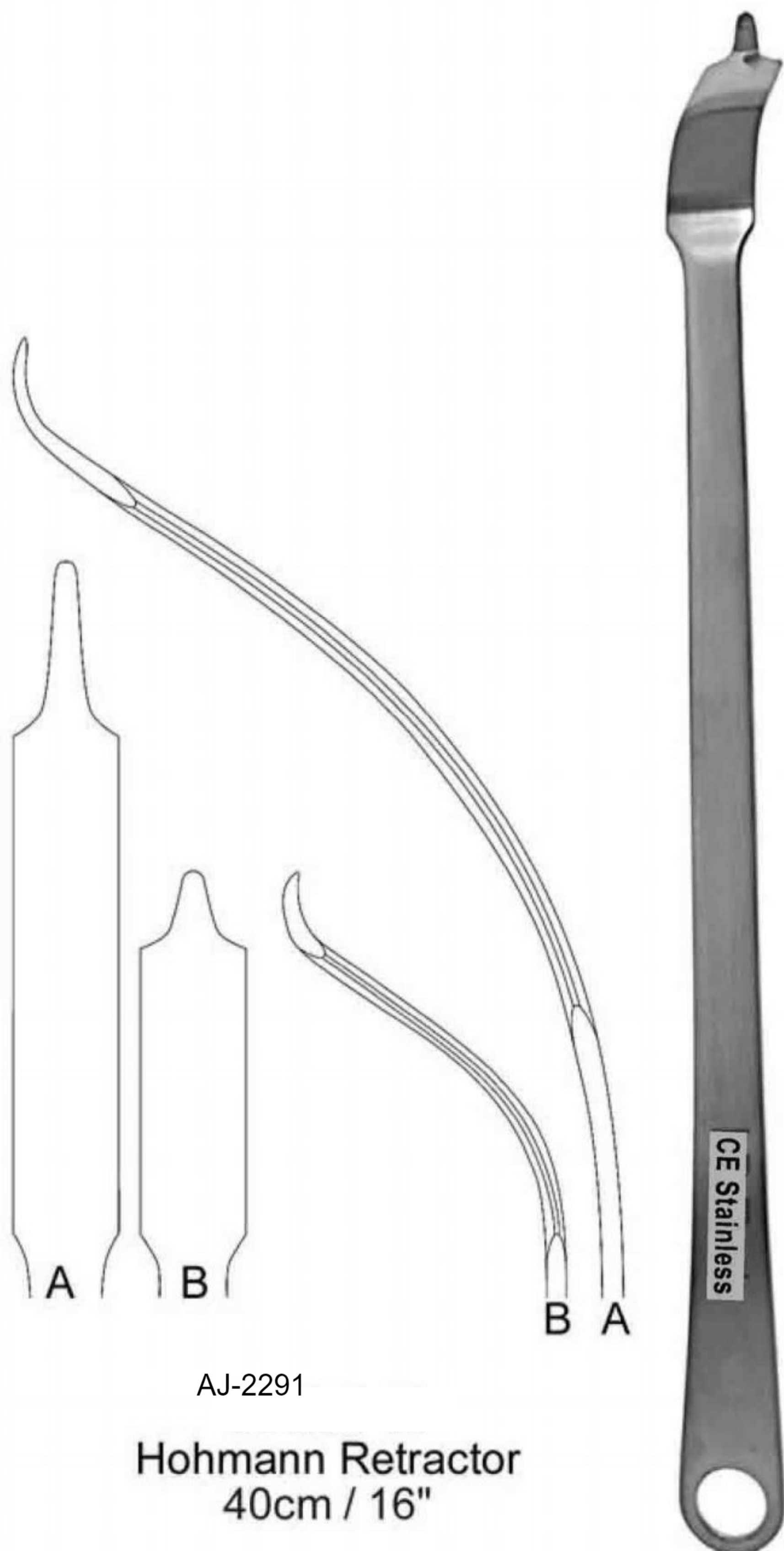
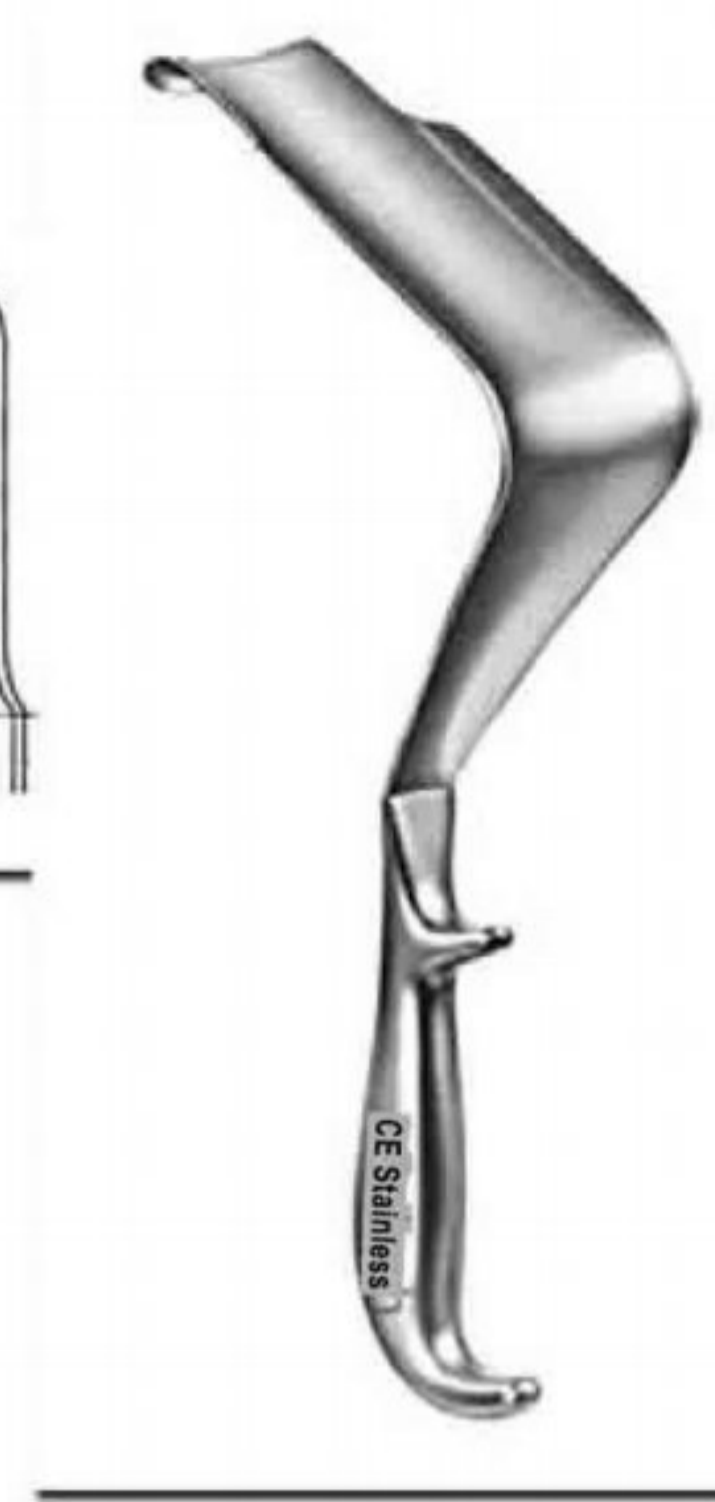
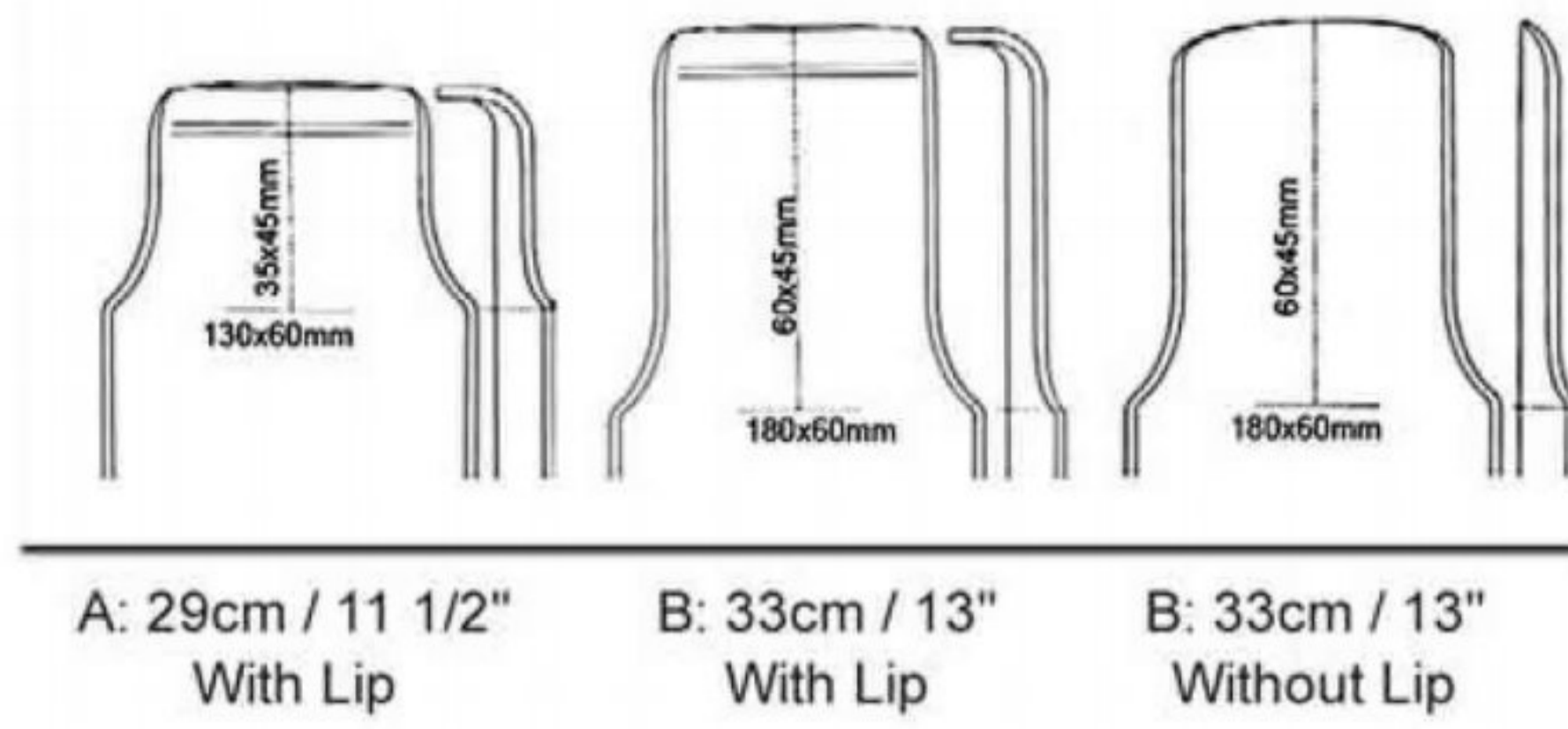

AJ-2291
Hohmann Retractor
40cm / 16"

- A: 22mm Blade
2 Finger Rings Long Round → 
- B: 22mm Blade
1 Finger Ring Short Round → 

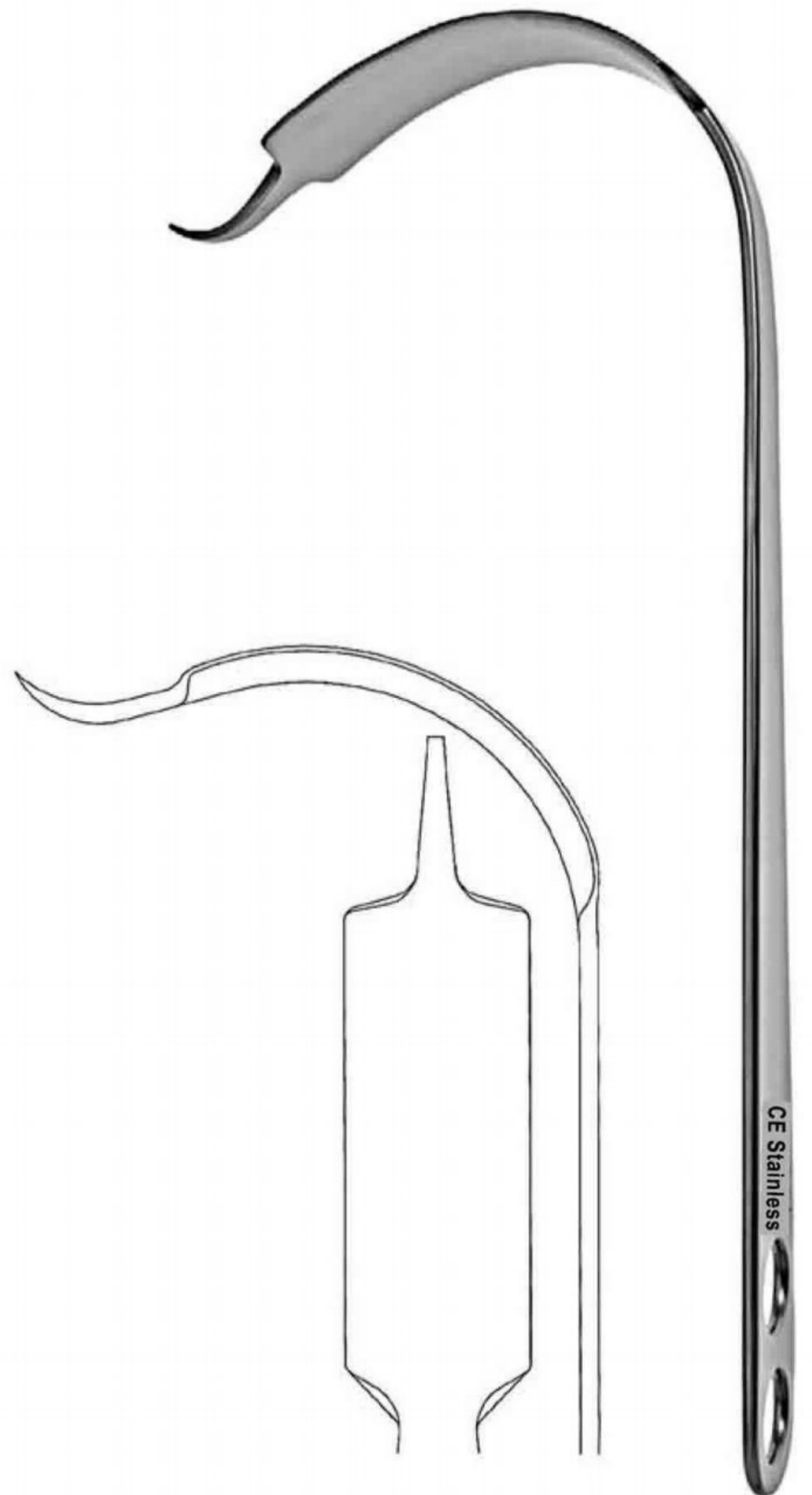

AJ-2292
Hohmann Retractor
33cm / 13"
40mm Blade Width

CHISELS - GOUGES - OSTEOTOMES



AJ-2293
Virchow
Skull Breaker
7.5cm / 3"

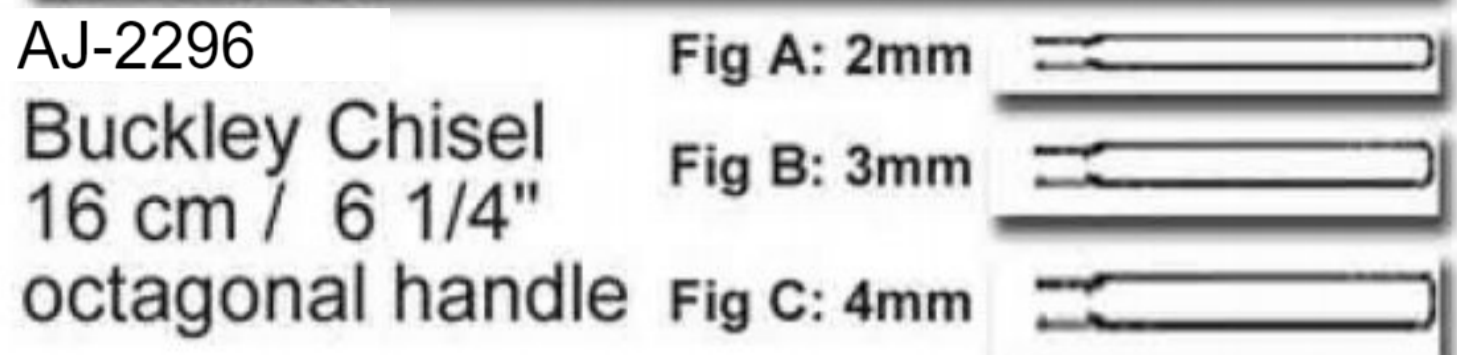

AJ-2296
Buckley Chisel
16 cm / 6 1/4"
octagonal handle

Fig A: 2mm
Fig B: 3mm
Fig C: 4mm

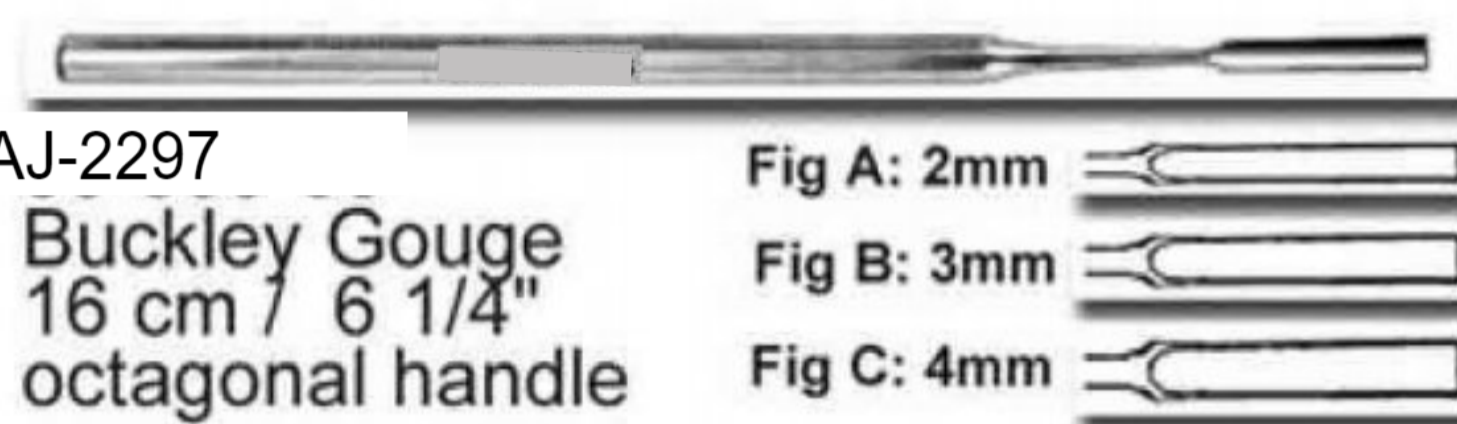

AJ-2297
Buckley Gouge
16 cm / 6 1/4"
octagonal handle

Fig A: 2mm
Fig B: 3mm
Fig C: 4mm

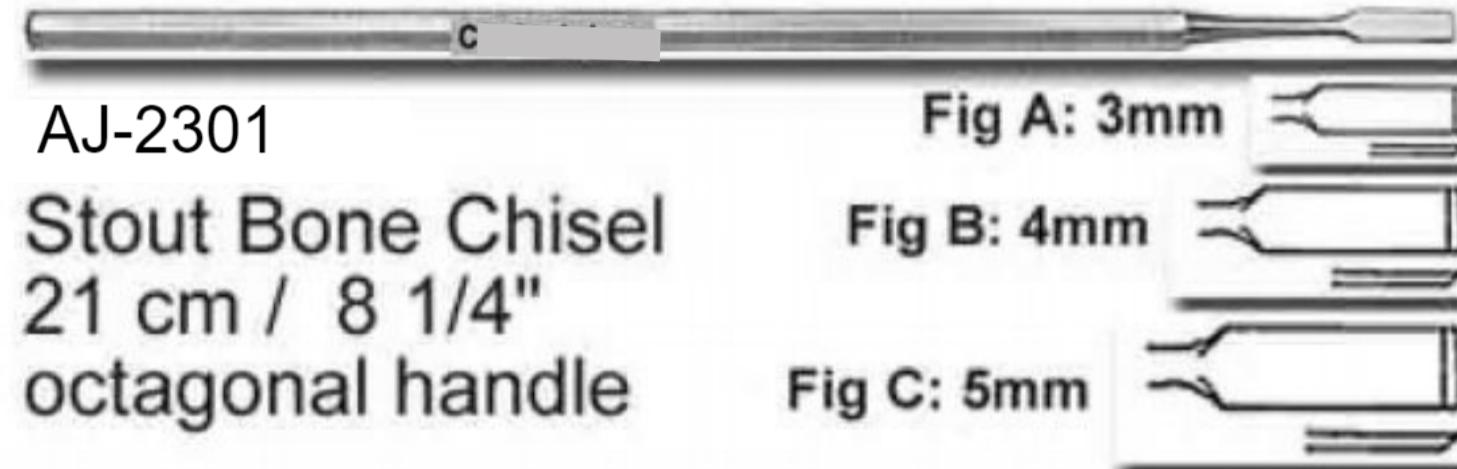

AJ-2301
Stout Bone Chisel
21 cm / 8 1/4"
octagonal handle

Fig A: 3mm
Fig B: 4mm
Fig C: 5mm

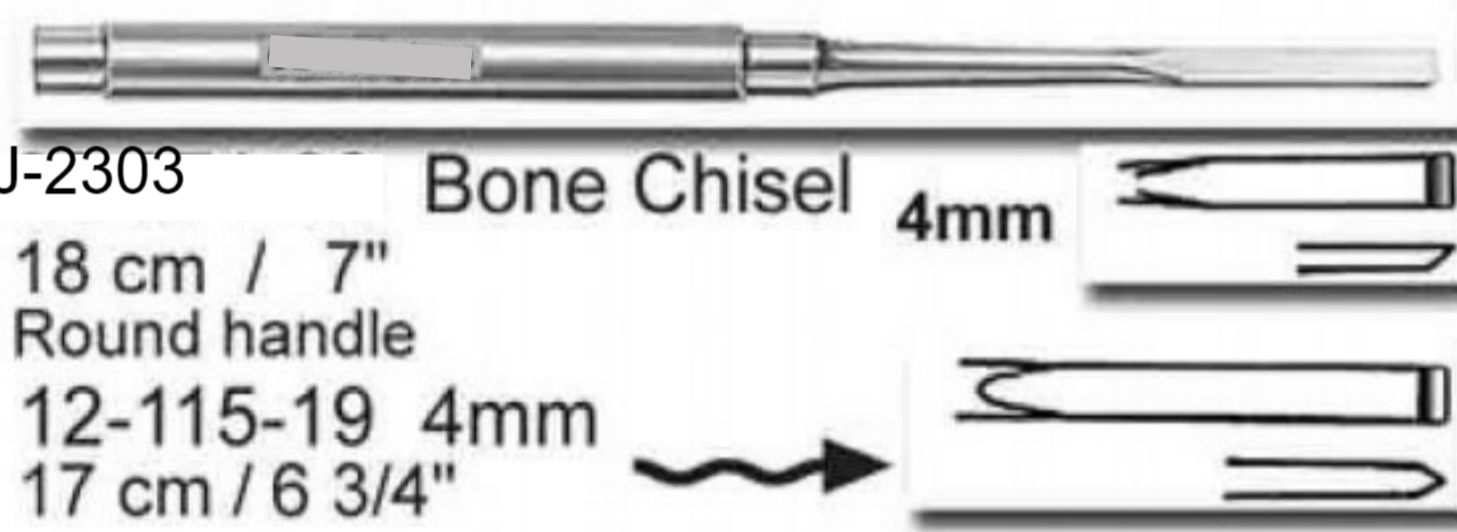

AJ-2303
Bone Chisel
18 cm / 7"
Round handle
12-115-19 4mm
17 cm / 6 3/4"

4mm

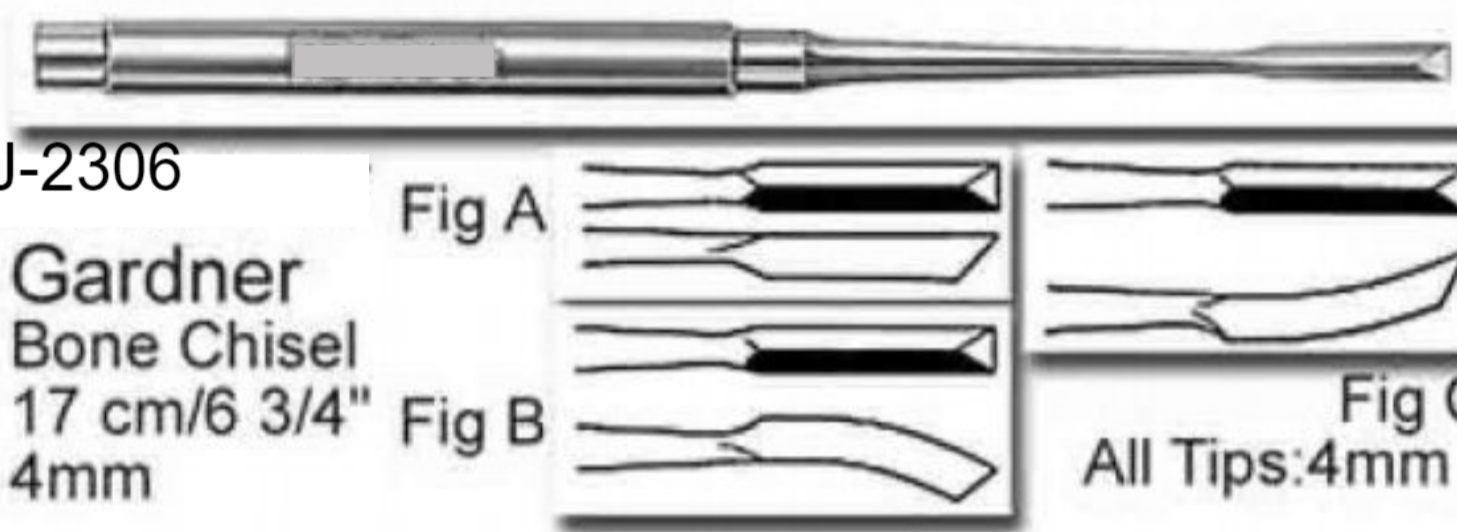

AJ-2306
Gardner
Bone Chisel
17 cm / 6 3/4"
4mm

Fig A
Fig B
All Tips: 4mm

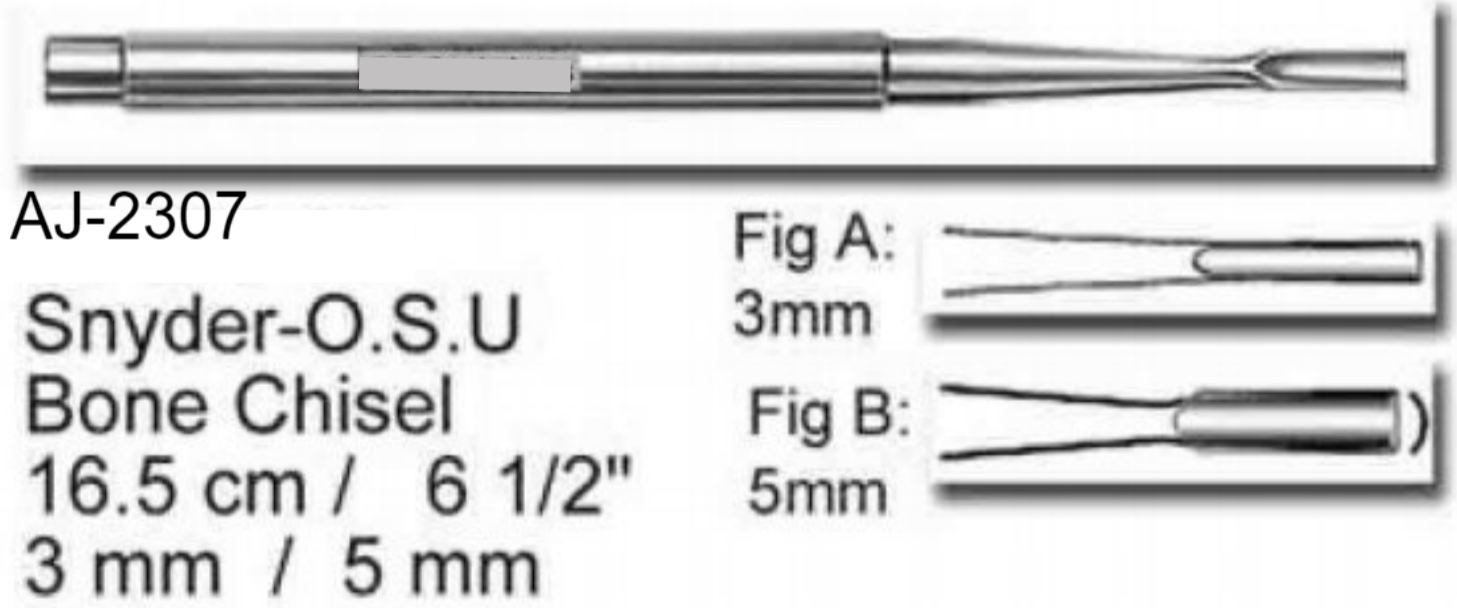

AJ-2307
Snyder-O.S.U
Bone Chisel
16.5 cm / 6 1/2"
3 mm / 5 mm

Fig A: 3mm
Fig B: 5mm



AJ-2294
Bone Chisel
18 cm / 7" Octagonal Handle

4mm

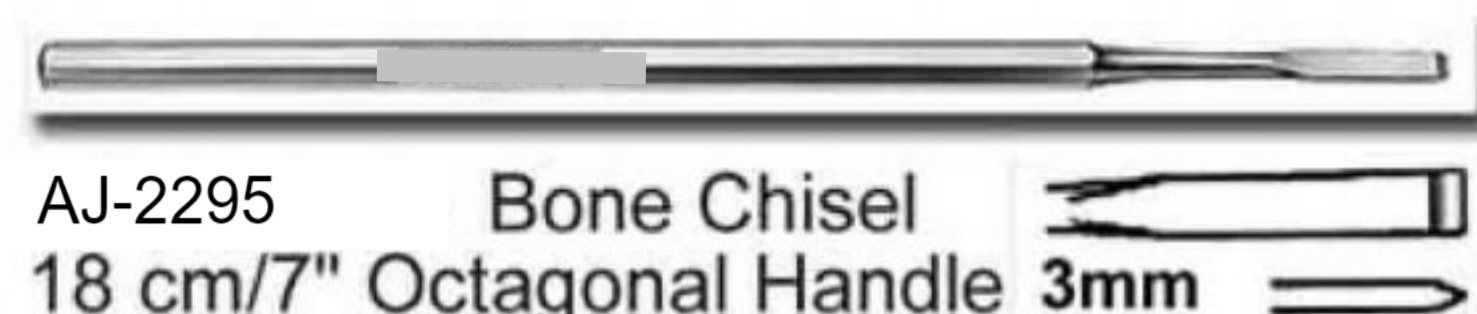

AJ-2295
Bone Chisel
18 cm / 7" Octagonal Handle

3mm

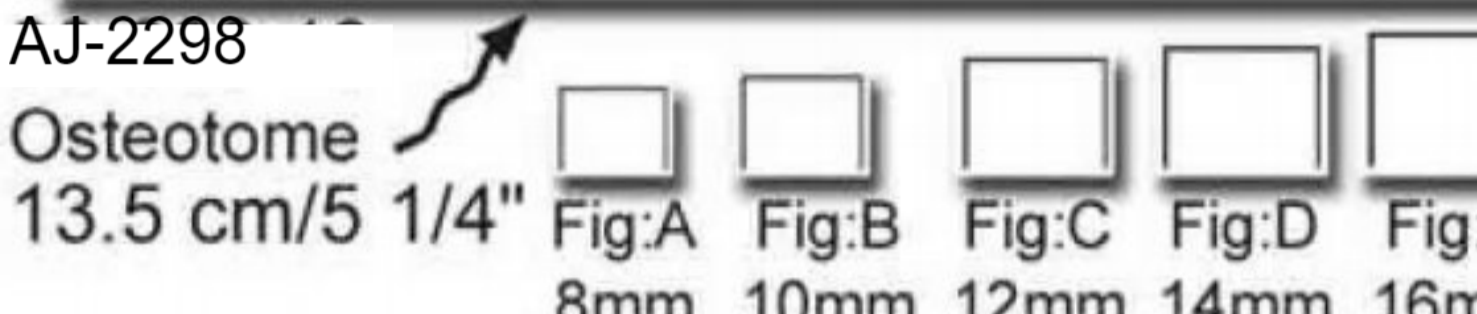

AJ-2298
Osteotome
13.5 cm / 5 1/4"

Fig:A 8mm Fig:B 10mm Fig:C 12mm Fig:D 14mm Fig:E 16mm

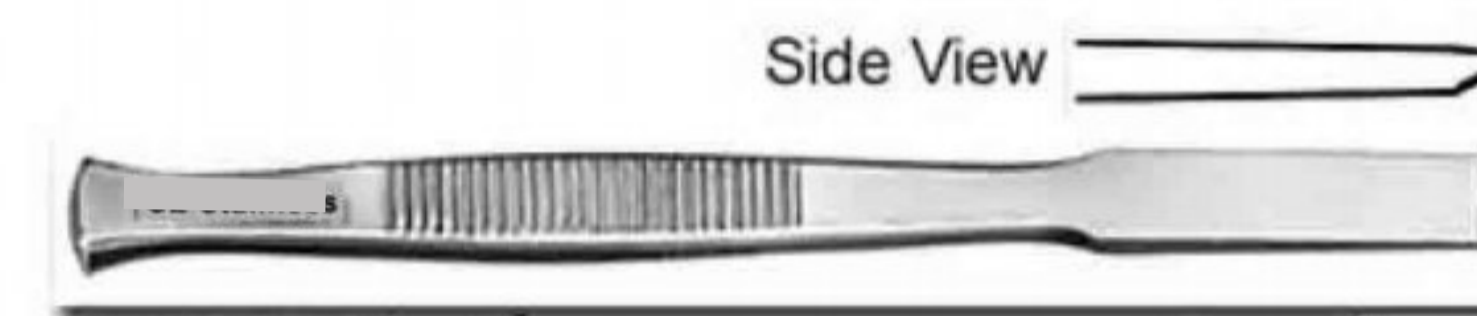

AJ-2302
Chisel
13.5 cm / 5 1/4"

Fig:A 8mm Fig:B 10mm Fig:C 12mm Fig:D 14mm Fig:E 16mm

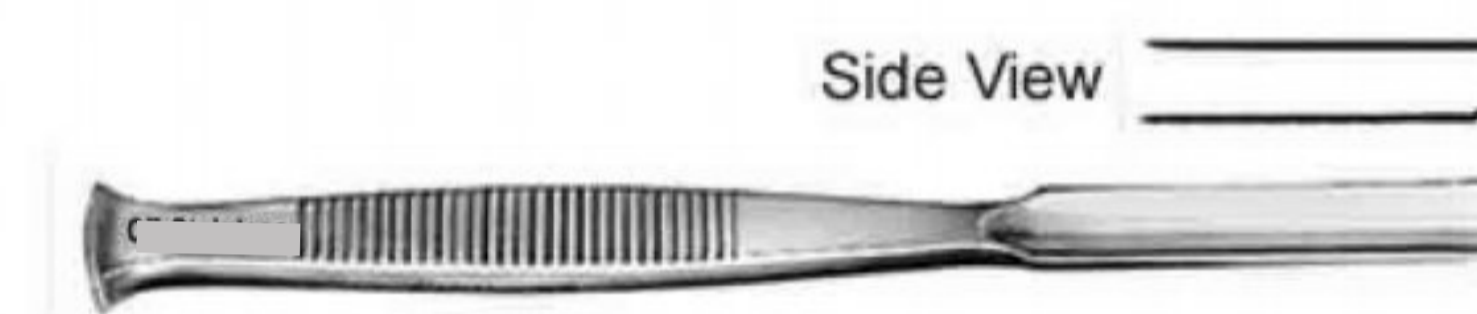

AJ-2304
Gouge
13.5 cm / 5 1/4"

Fig:A 8mm Fig:B 10mm Fig:C 12mm Fig:D 14mm Fig:E 16mm

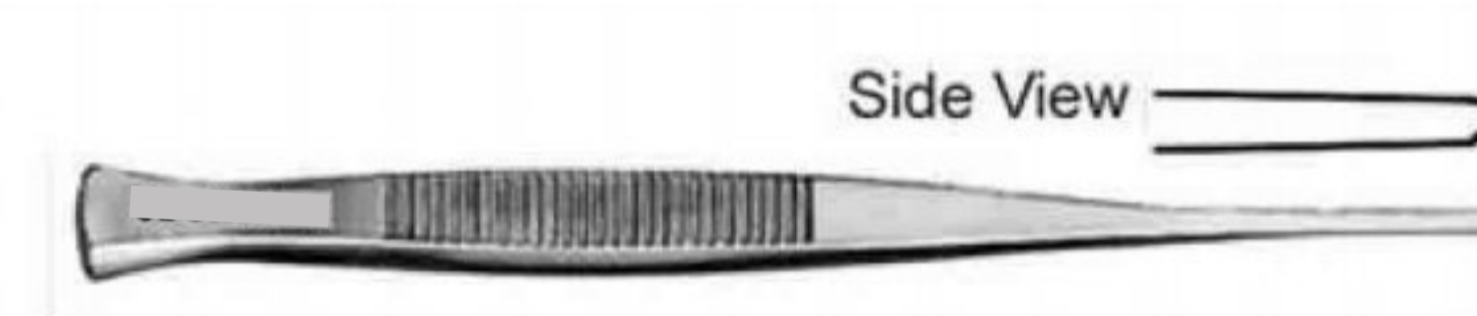

AJ-2308
Partsch Chisel
13.5 cm / 5 1/4"
&
17cm / 6 3/4"

Fig:A 2mm Fig:B 3mm Fig:C 4mm Fig:D 5mm Fig:E 6mm

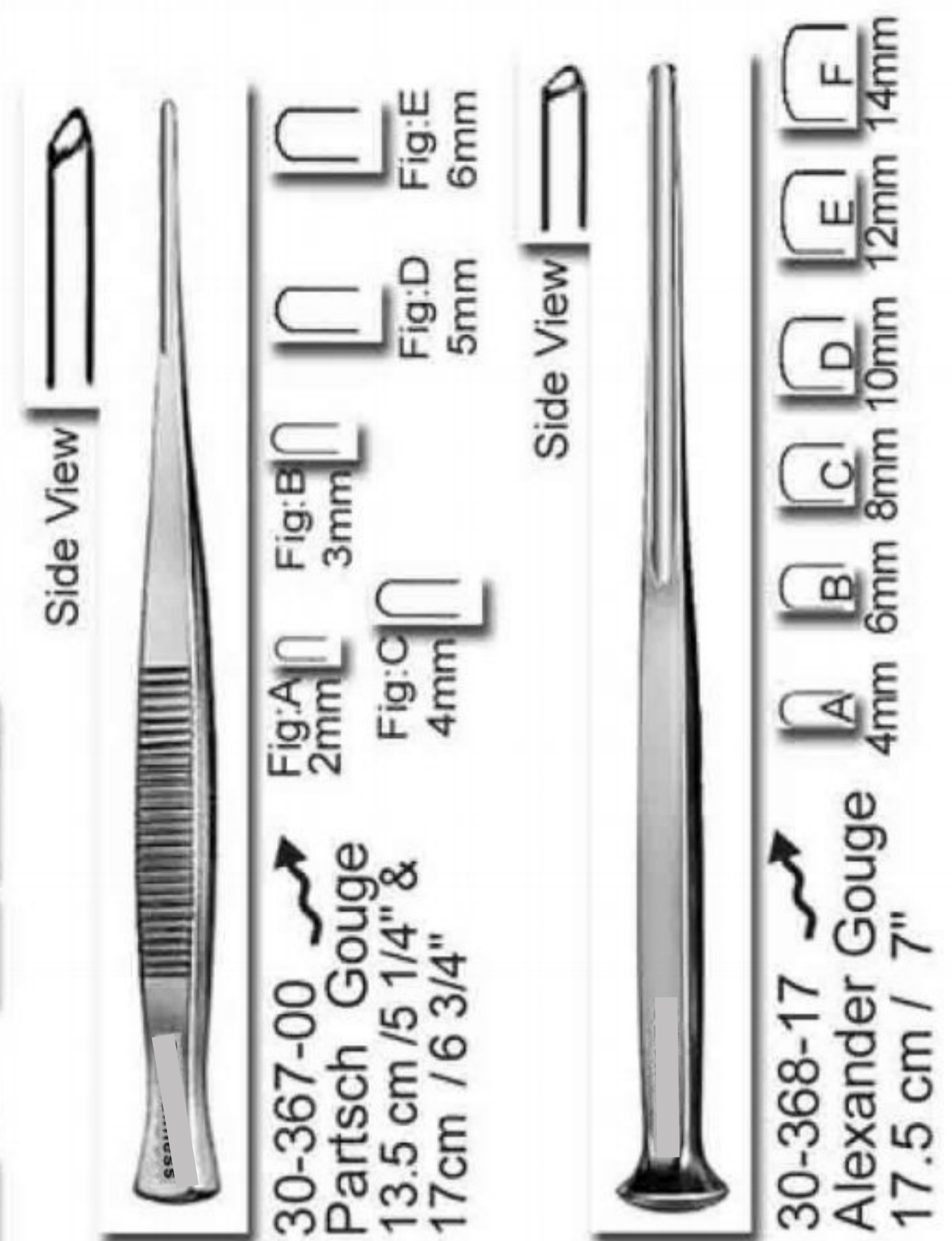

AJ-2305
O.S.U.
Bone Chisel
17 cm / 6 3/4"
7mm

Also available
30-373-17 O.S.U.
17 cm / 6 3/4" 9mm

Available in
15mm
20mm
25mm
30mm
38mm
44mm
50mm

TIP

Three sizes in Lambotte Mini Osteotome (see below)

Available Tip Sizes

2mm / 3mm / 4mm / 6mm / 8mm / 10mm / 12mm / 15mm

AJ-2311 (12.5 cm / 5")
Lambotte, Mini Osteotome

AJ-2312 (17 cm / 6 3/4")
Lambotte, Mini Osteotome
3mm / 4mm / 6mm /
8mm / 10mm / 12mm / 15mm

AJ-2313 (24 cm / 9 1/2")
Lambotte, Osteotome
15mm / 20mm / 25mm /
30mm / 38mm / 44mm / 50mm

TIP

Side View

Curved Tip

Other Lambotte Mini Osteotomes sizes / Tips

For Image, please see photo of above Osteotome.

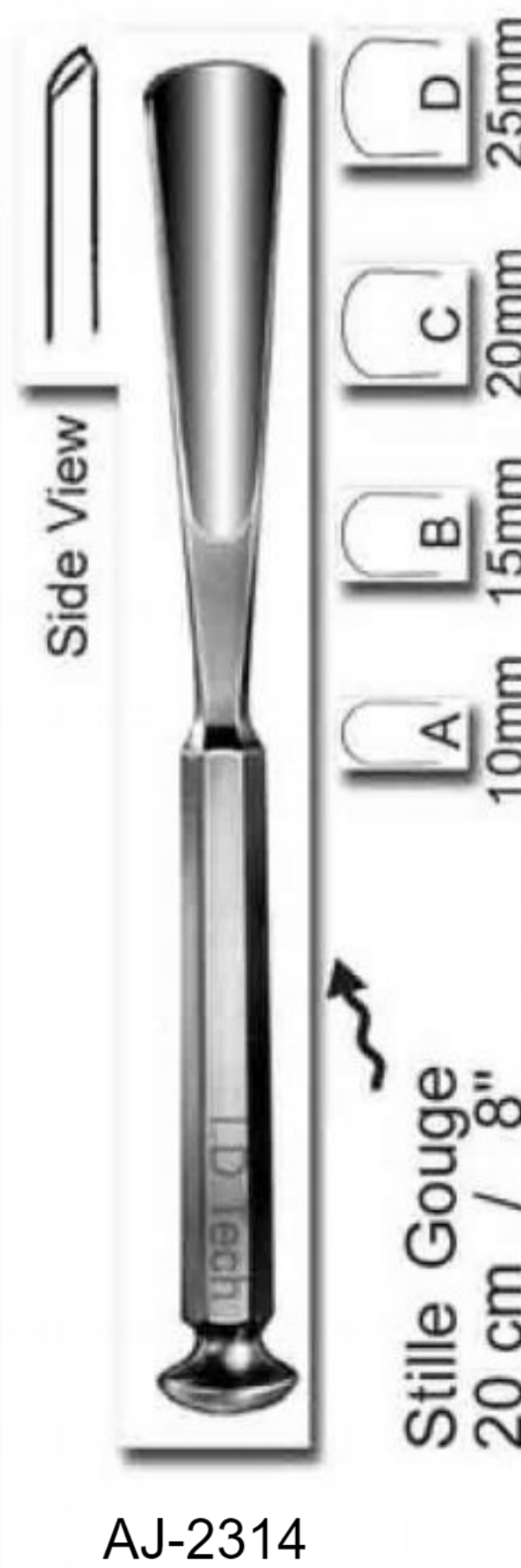

AJ-2314

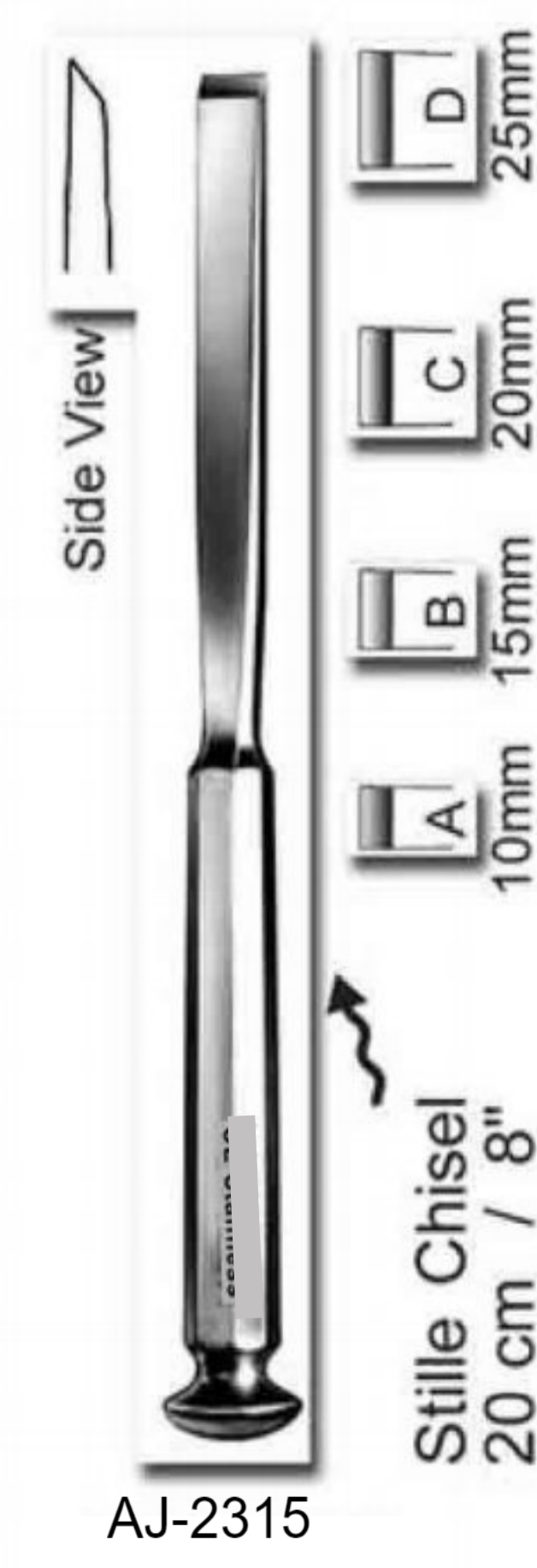

AJ-2315

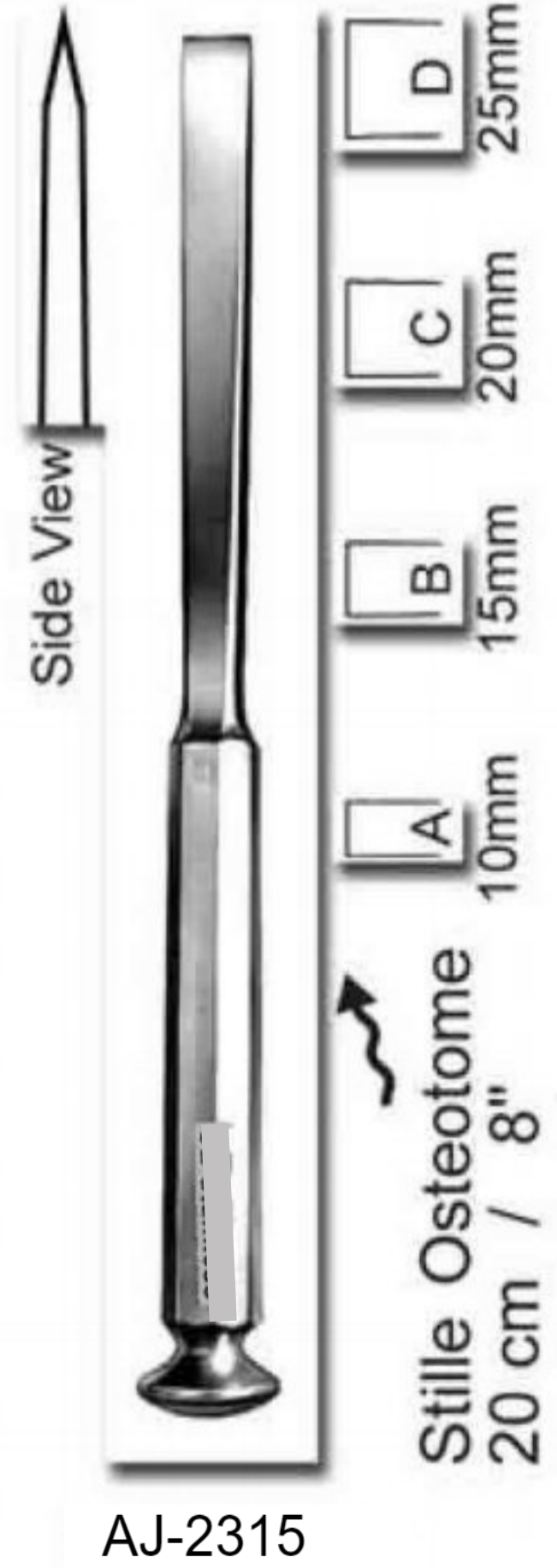

AJ-2315

CHISELS - GOUGES - OSTEOTOMES

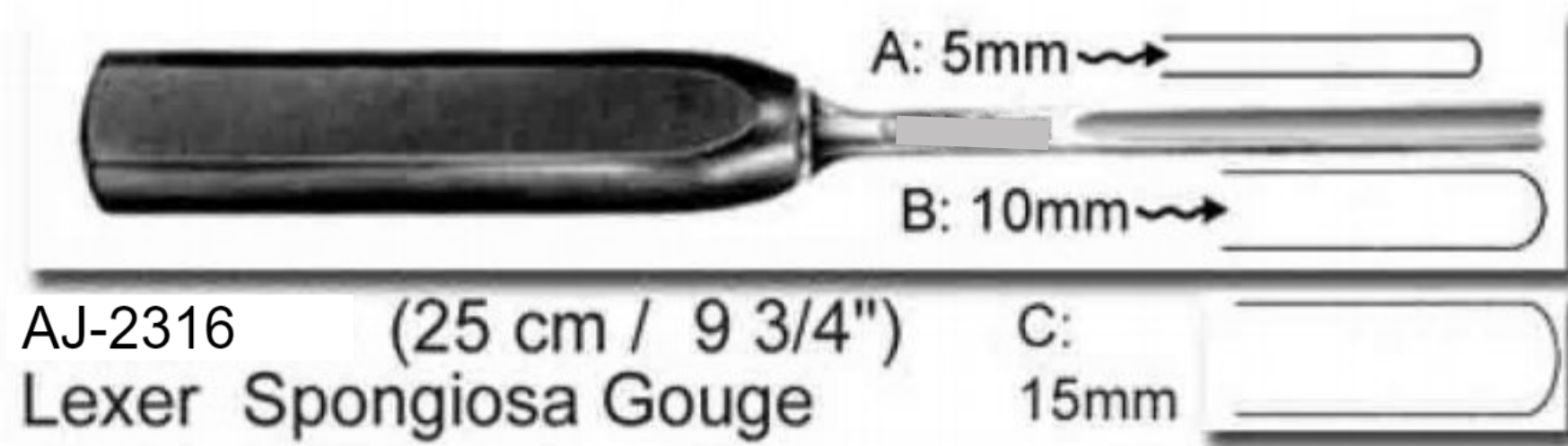

AJ-2316 (25 cm / 9 3/4")
Lexer Spongiosa Gouge

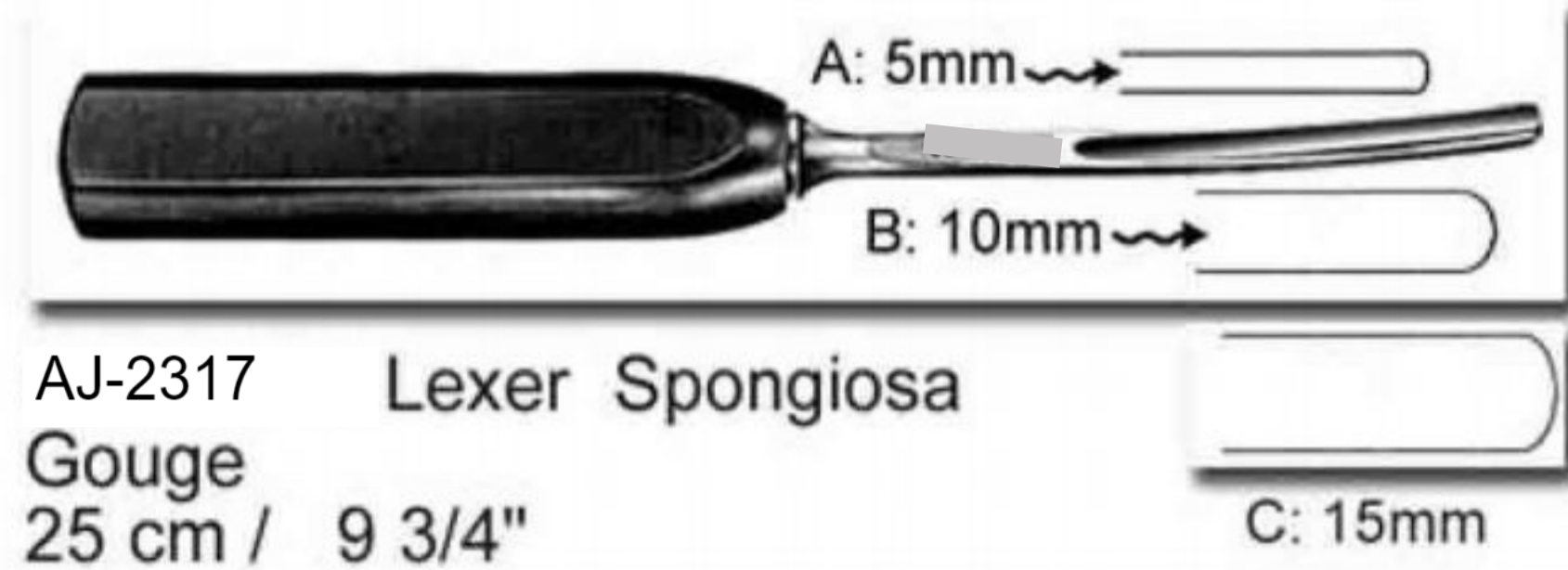

AJ-2317 Lexer Spongiosa
Gouge
25 cm / 9 3/4"

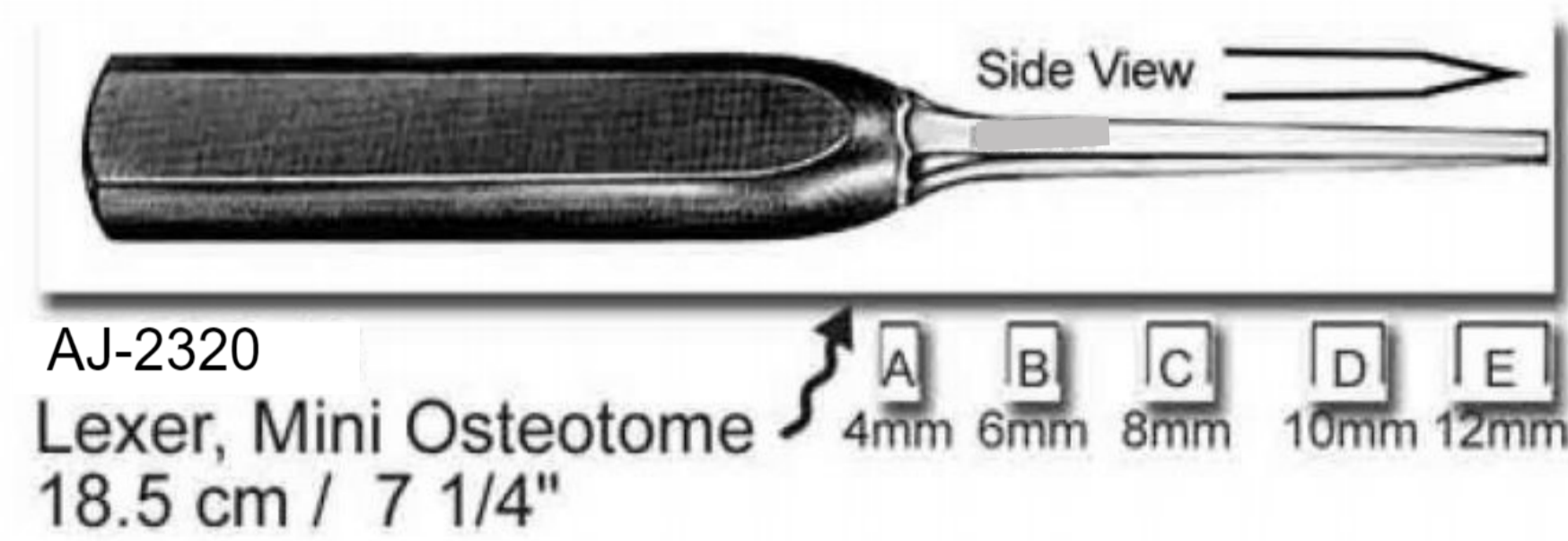

AJ-2320
Lexer, Mini Osteotome
18.5 cm / 7 1/4"

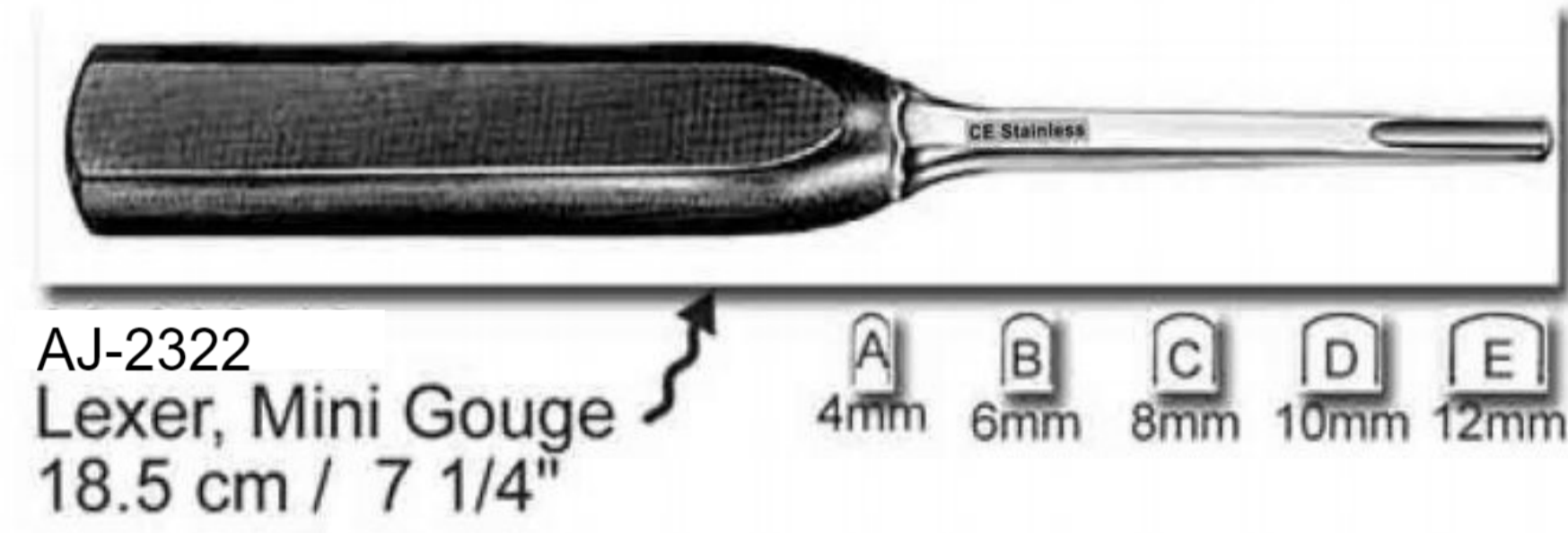

AJ-2322
Lexer, Mini Gouge
18.5 cm / 7 1/4"

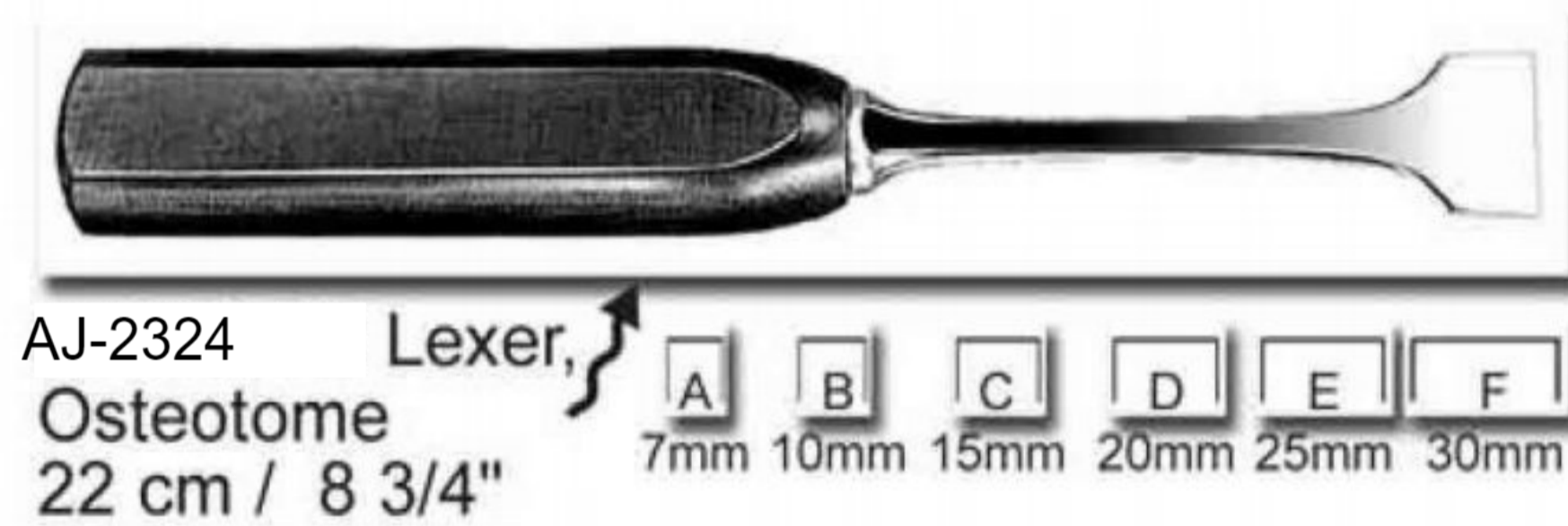

AJ-2324 Lexer,
Osteotome
22 cm / 8 3/4"

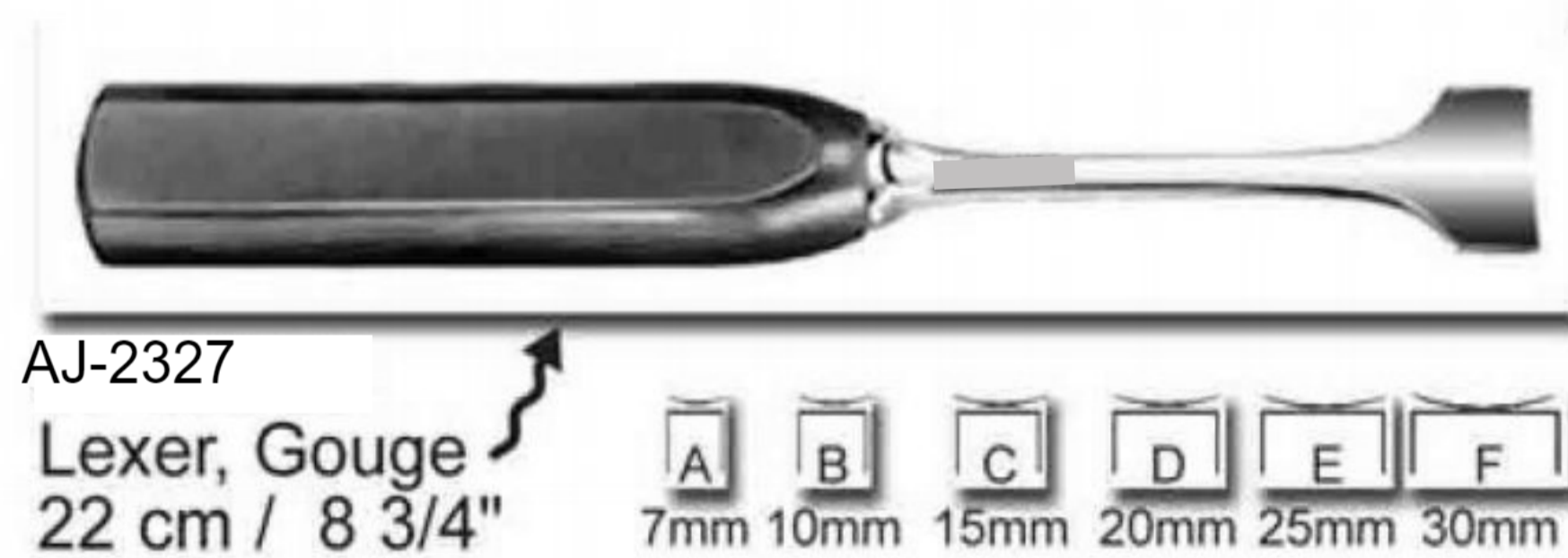

AJ-2327
Lexer, Gouge
22 cm / 8 3/4"

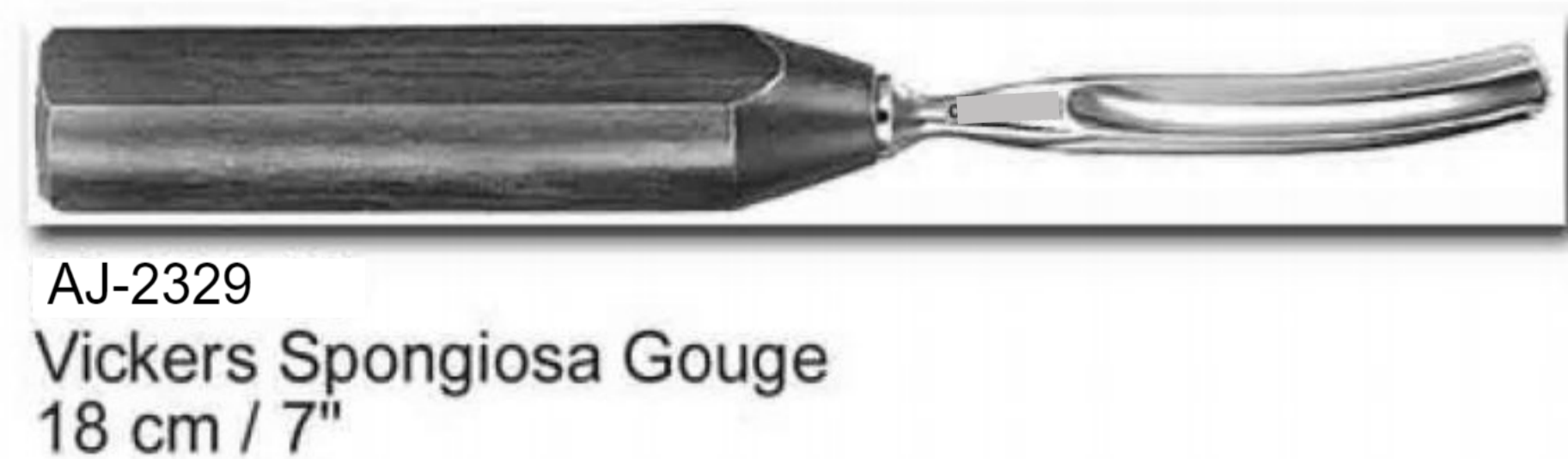

AJ-2329
Vickers Spongiosa Gouge
18 cm / 7"

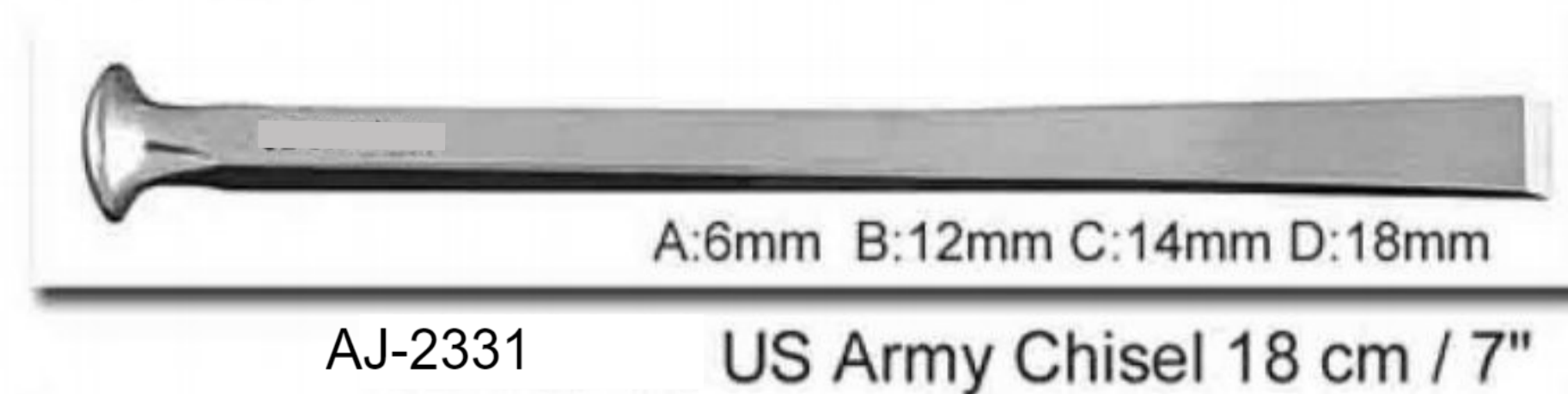

AJ-2331 US Army Chisel 18 cm / 7"

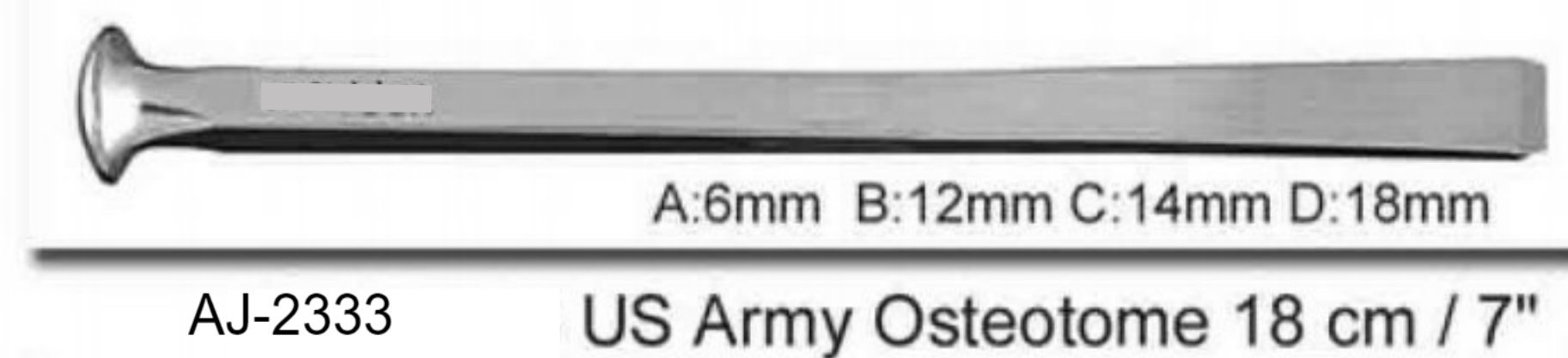

AJ-2333 US Army Osteotome 18 cm / 7"

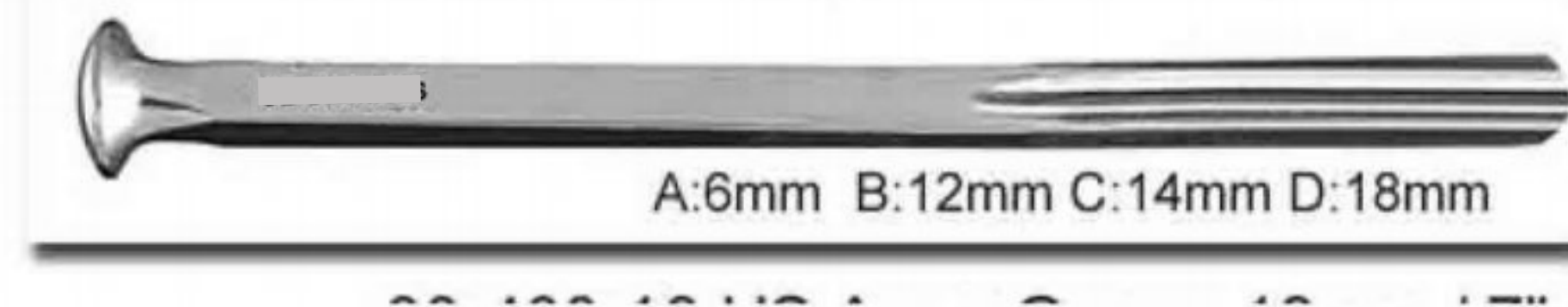

A: 6mm B: 12mm C: 14mm D: 18mm



AJ-2318

Smith-Petersen
Osteotome
20.5 cm / 8"

Available Tips

6mm
9mm
13mm
16mm
19mm
25mm
32mm

TIP

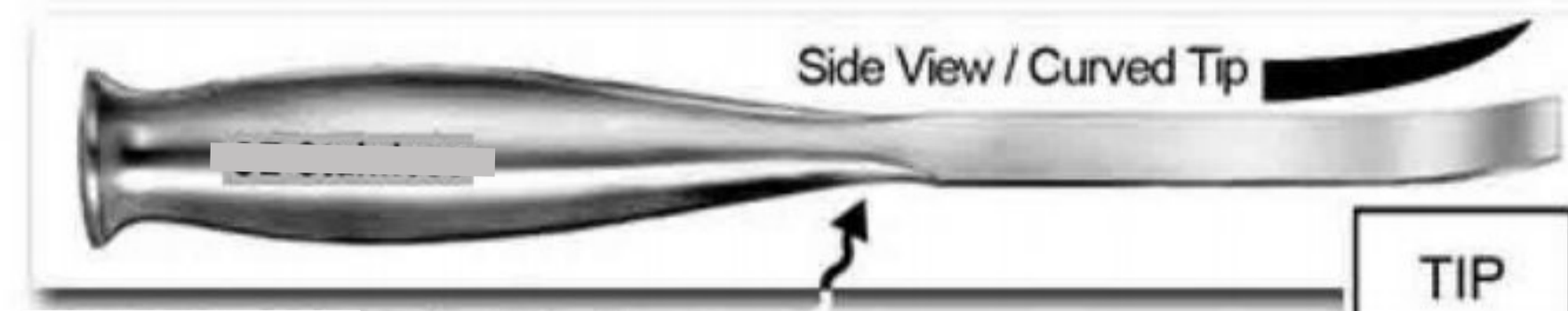

AJ-2319 Smith-Petersen
Osteotome
20.5 cm / 8"

6mm / 9mm / 13mm /
16mm / 19mm / 25mm / 32mm

TIP



AJ-2321 Smith-Petersen Gouge
20.5 cm / 8"

TIP

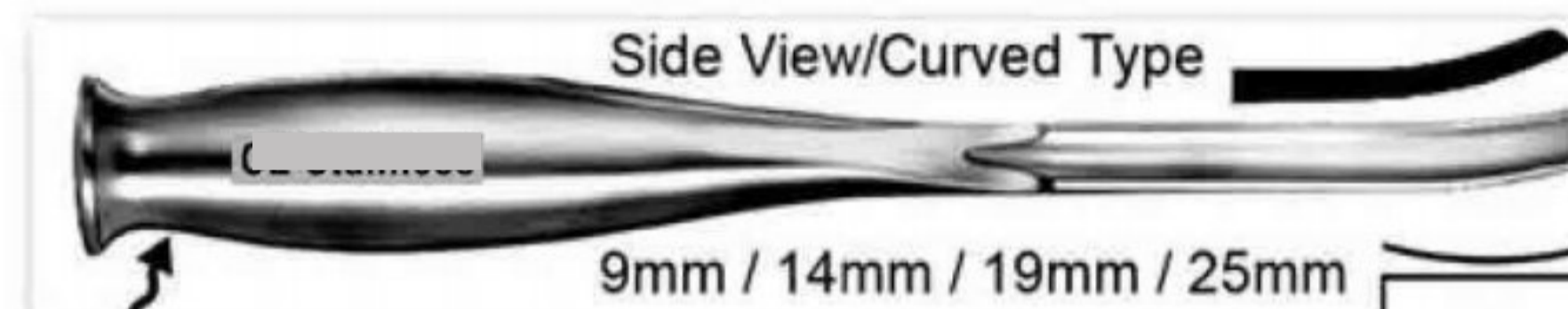

AJ-2323 Smith-Petersen Gouge
20.5 cm / 8"

TIP



AJ-2325 Hoke Osteotome
17 cm / 6 3/4"

3mm / 5mm /
6mm / 8mm / 9mm

TIP



AJ-2326 Hibbs Osteotome
24.5 cm / 9 3/4"

6mm / 13mm / 19mm / 25mm / 32mm

TIP



AJ-2328 Hibbs Chisel
24.5 cm / 9 3/4"

6mm / 13mm / 19mm / 25mm / 32mm

TIP



AJ-2330 Hibbs Gouge
24.5 cm / 9 3/4"

6mm / 13mm / 19mm / 25mm / 32mm

TIP

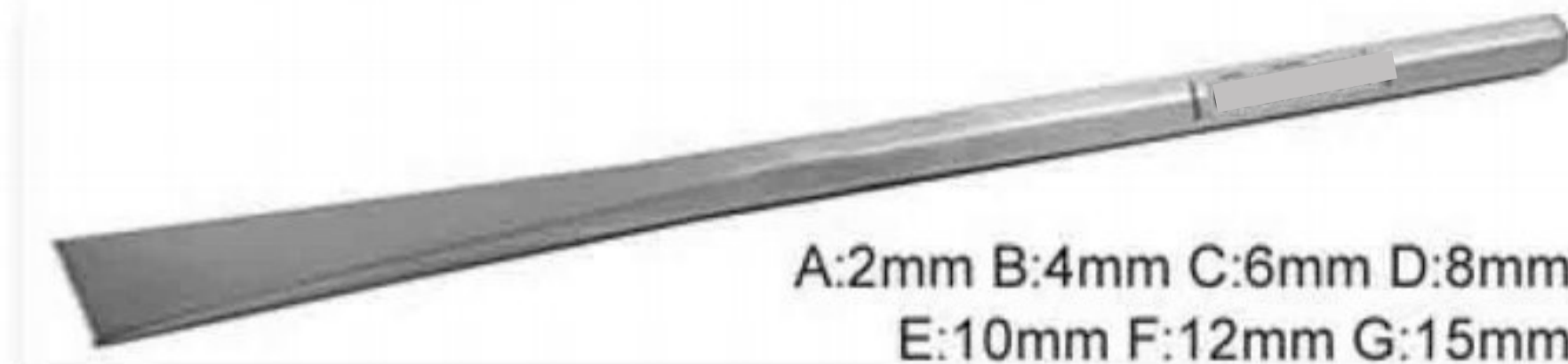

AJ-2332 Sheehan Osteotome 16cm / 6 1/2"

A: 2mm B: 4mm C: 6mm D: 8mm
E: 10mm F: 12mm G: 15mm



B: Curved / Left

C: Curved / Right

A: Straight

AJ-2332 Sheehan Osteotome 16cm / 6 1/2"

CHISELS - GOUGES - OSTEOTOMES

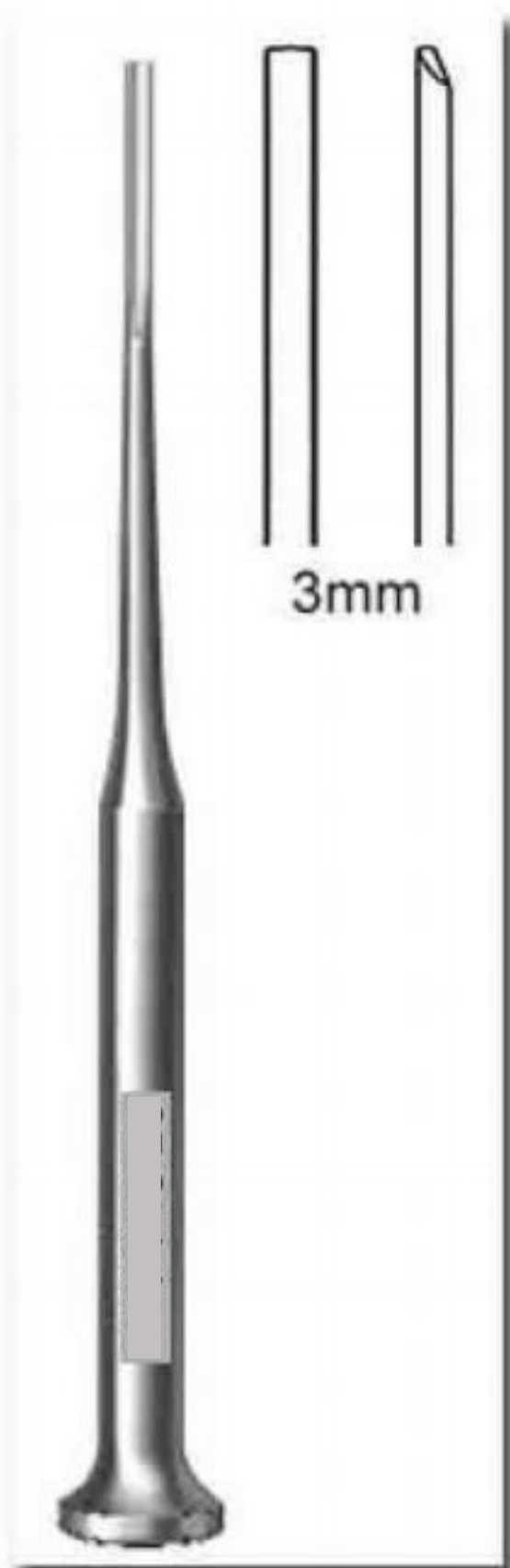

AJ-2334

Shoulder Penetrating Gouge 21cm/8 1/2"

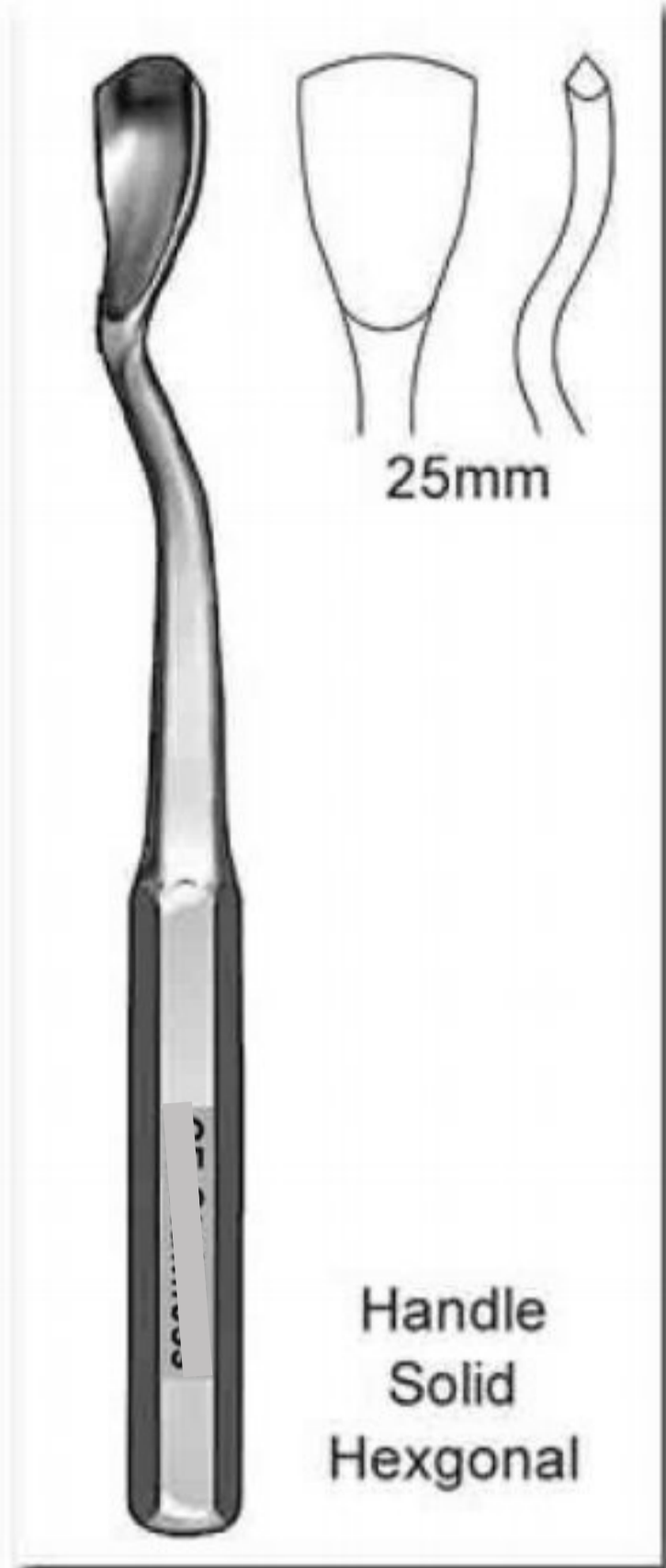

AJ-2335

Swan Neck Gouge 23cm/9"

Handle Solid Hexagonal

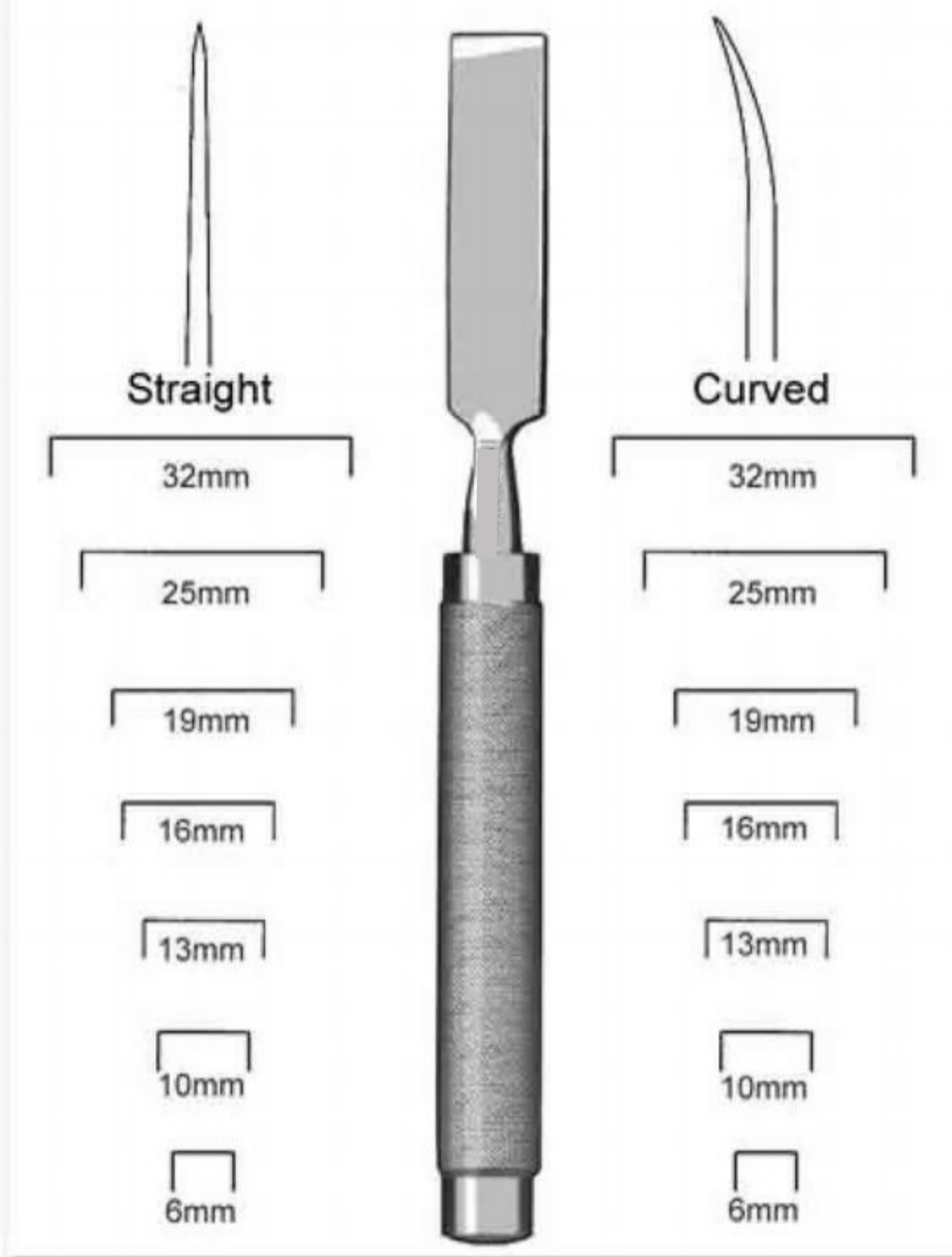

AJ-2336

Cobb Osteotome 28cm/11"

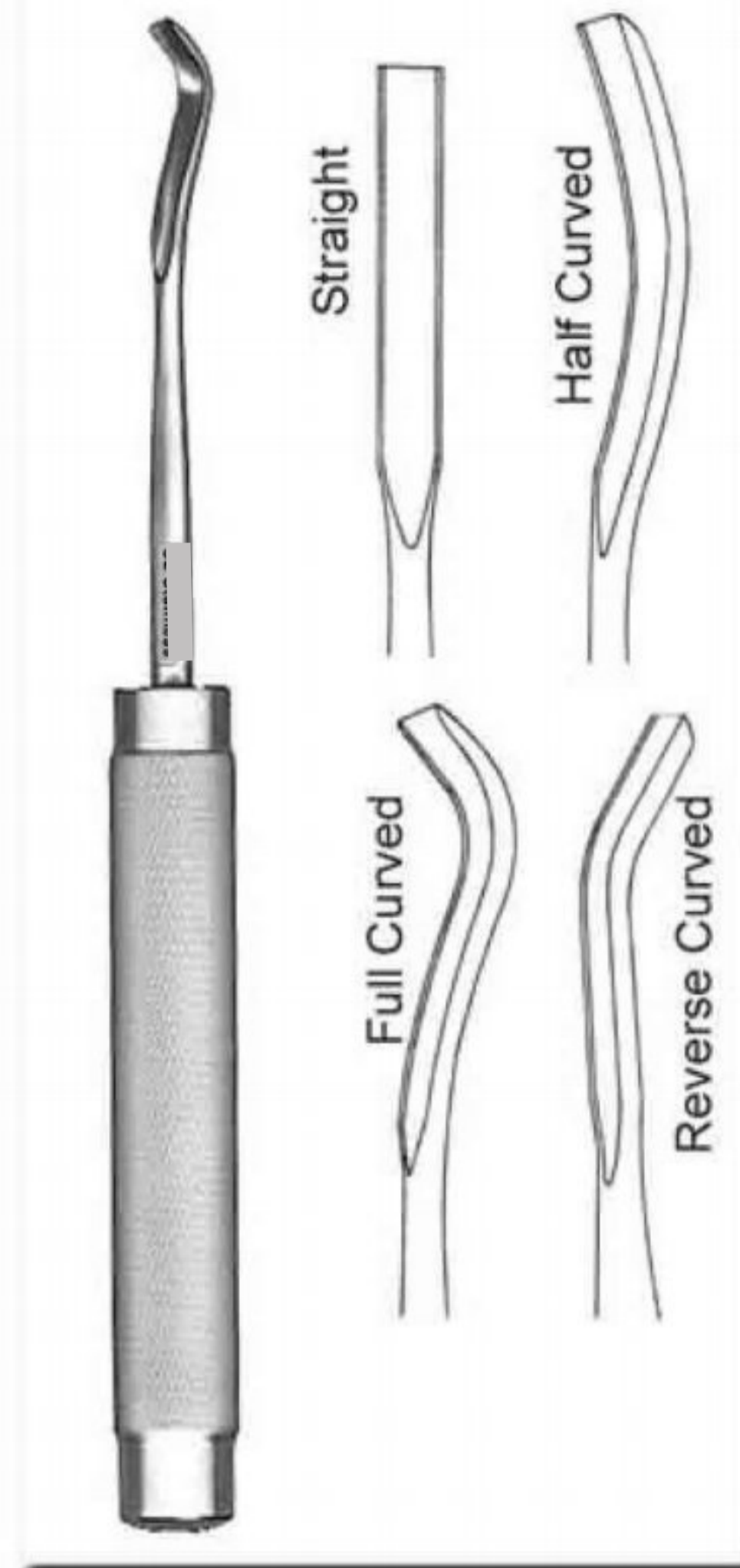

AJ-2337

Cobb Gouge 28cm/11"

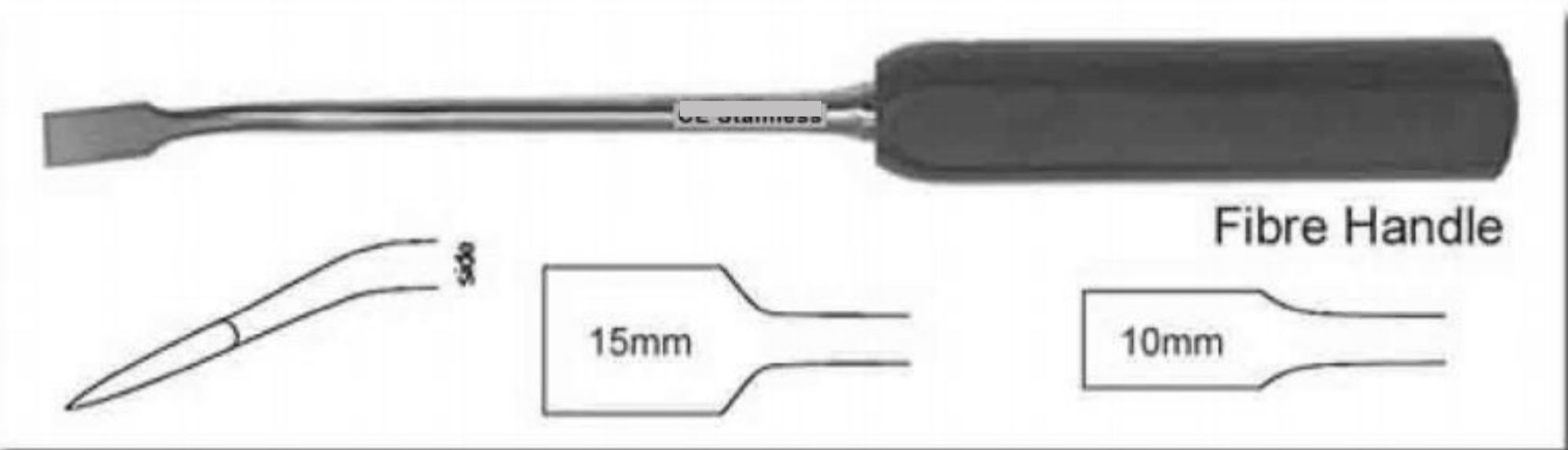

AJ-2338

Lexer Osteotome Angled / 28cm/11"



AJ-2339

Cinelli Osteotome 15.5cm/6 1/2"

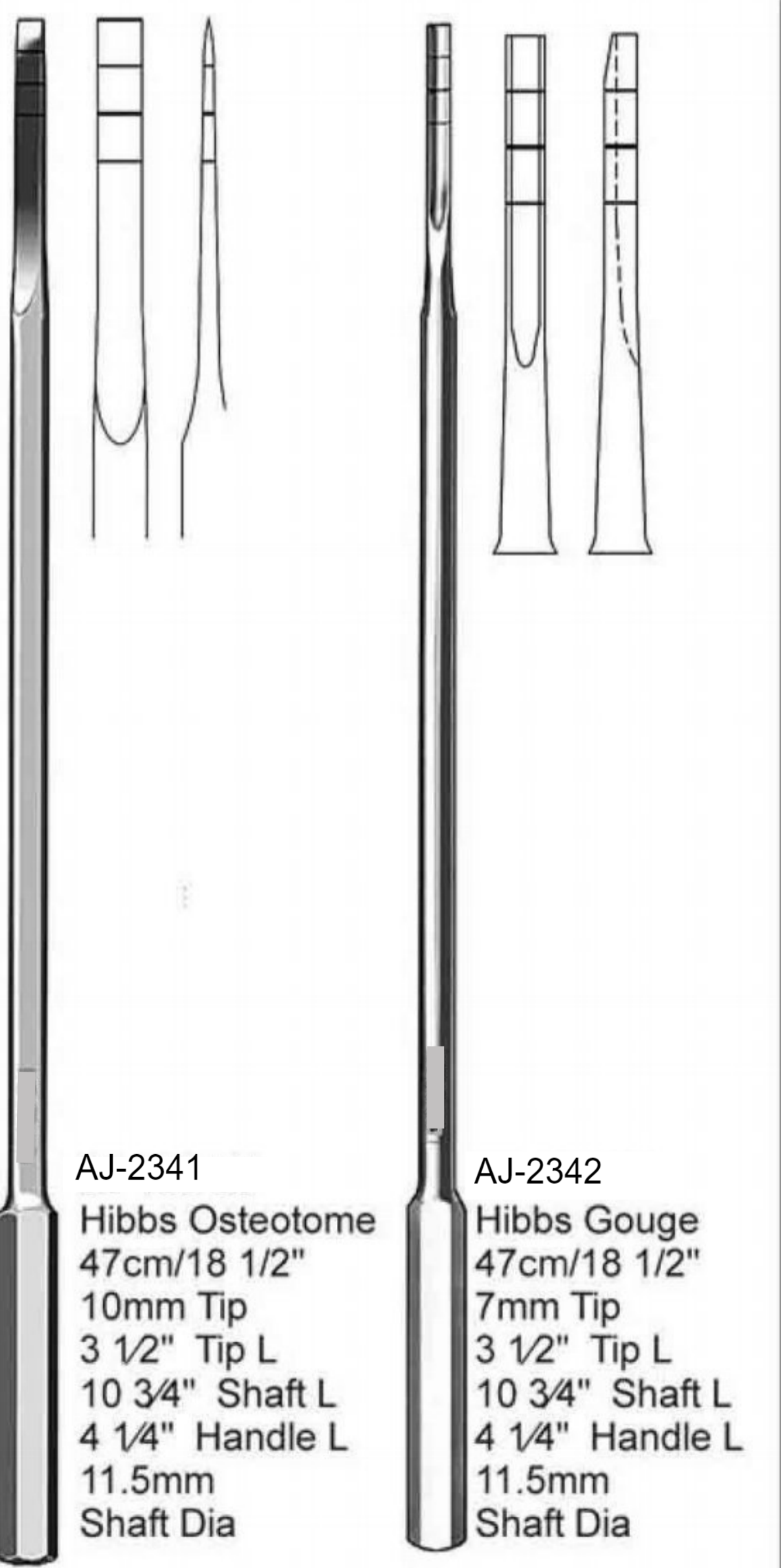

AJ-2341

Hibbs Osteotome 47cm/18 1/2"
10mm Tip
3 1/2" Tip L
10 3/4" Shaft L
4 1/4" Handle L
11.5mm Shaft Dia

AJ-2342

Hibbs Gouge 47cm/18 1/2"
7mm Tip
3 1/2" Tip L
10 3/4" Shaft L
4 1/4" Handle L
11.5mm Shaft Dia



AJ-2343

Spinal Fusion Gouge 24cm/9 1/2"
6mm Tip

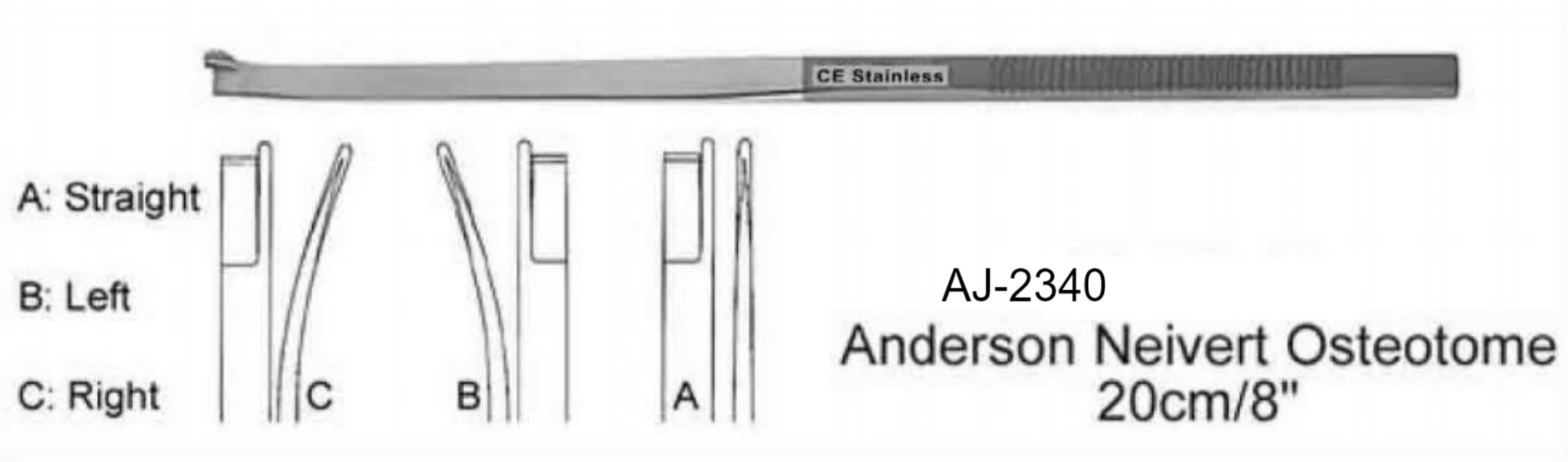

AJ-2340

Anderson Neivert Osteotome 20cm/8"

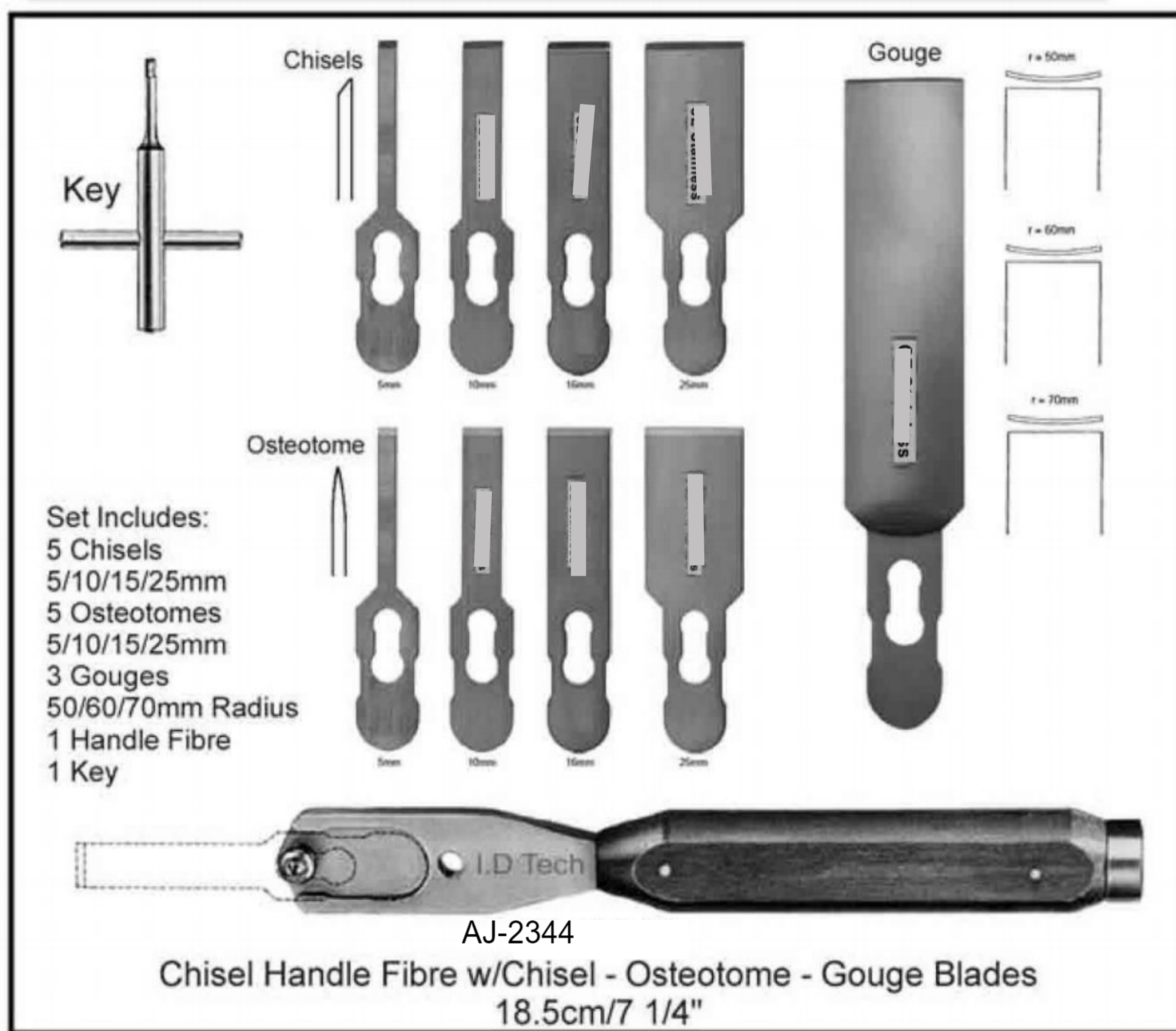

Set Includes:
5 Chisels
5/10/15/25mm
5 Osteotomes
5/10/15/25mm
3 Gouges
50/60/70mm Radius
1 Handle Fibre
1 Key

AJ-2344

Chisel Handle Fibre w/Chisel - Osteotome - Gouge Blades 18.5cm/7 1/4"

BONE CURETTES

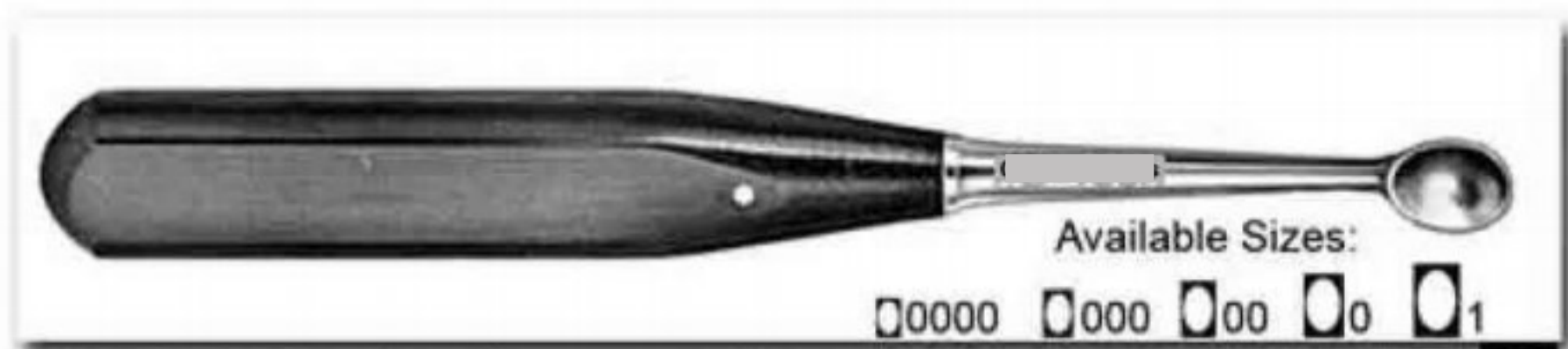

AJ-2345 (18.5 cm / 7 1/4")
Volkmann Bone Curette
oval with plastic handle



AJ-2347 A / B / C
Volkmann Bone Curette,
double-ended (oval / round).
Available in 3 sizes (Length)
A: 13 cm / 5"
B: 16 cm / 6 1/4"
C: 20 cm / 8"



AJ-2350 Bone Curette,
double-ended (round / oval) 21 cm / 8 1/4"

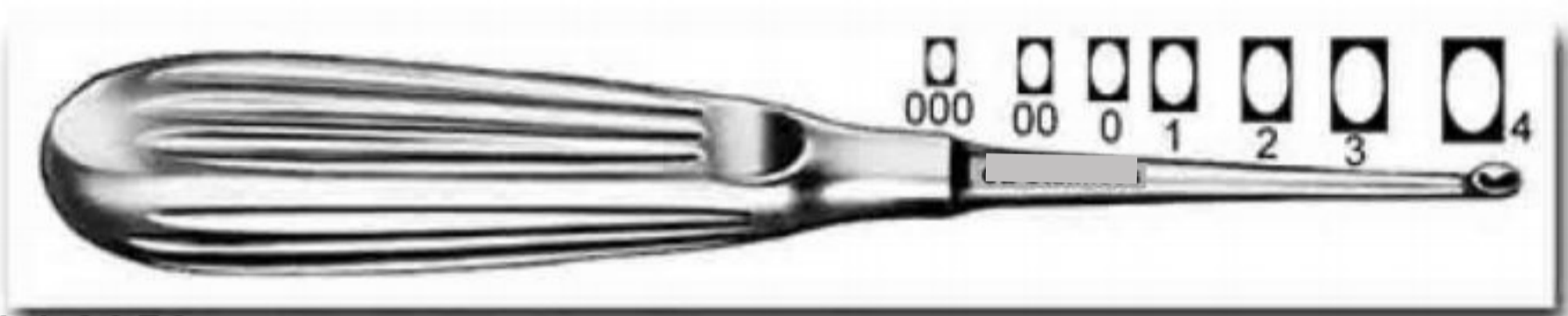

AJ-2352 Schede Bone Curette
17 cm / 6 3/4" oval with hollow handle



AJ-2354 Volkmann Bone Curette
17 cm / 6 3/4" oval, with hollow handle



AJ-2356 Bruns Bone Curette
17 cm / 6 3/4" Round, with hollow handle



AJ-2358 Spratt Bone Curette
17 cm / 6 3/4"
Oval, with hollow handle

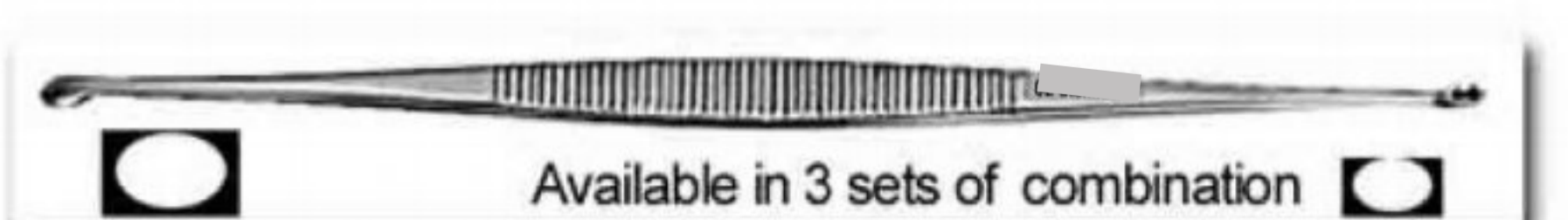

AJ-2360 A / B / C
Williger Bone Curette,
double-ended 13.5 cm / 5 1/4"



AJ-2362 A / B / C Williger
Bone Curette, 17 cm / 6 3/4"
double-ended oval / oval

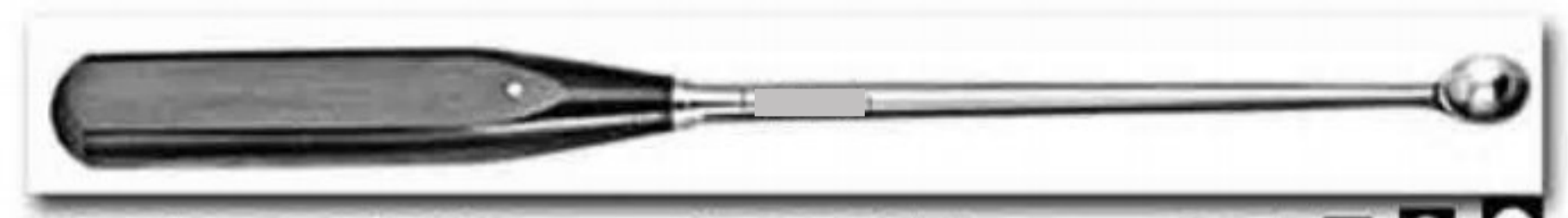

AJ-2346 (27.5 cm / 10 3/4")
Volkmann Bone Curette
oval with plastic handle



AJ-2348 Bruns Bone Curette
23 cm / 9" oval, solid



AJ-2349 A / B / C
Scoville Bone Curette
25 cm / 9 3/4"
oval, with hollow handle



AJ-2351 Simon Bone Curette
25 cm / 9 3/4"
oval, with hollow handle



AJ-2353 Modell USA
Bone Curette 16 cm / 6 1/4"
Oval, with hollow handle



AJ-2355 Modell USA
Bone Curette 15.5 cm / 6 "
Oval, with hollow handle



AJ-2357 Modell USA
Bone Curette 15.5 cm / 6 "
Oval, with hollow handle



AJ-2359 Halle Bone Curette
21 cm / 8 1/4" oval, malleable shaft,
with hollow handle

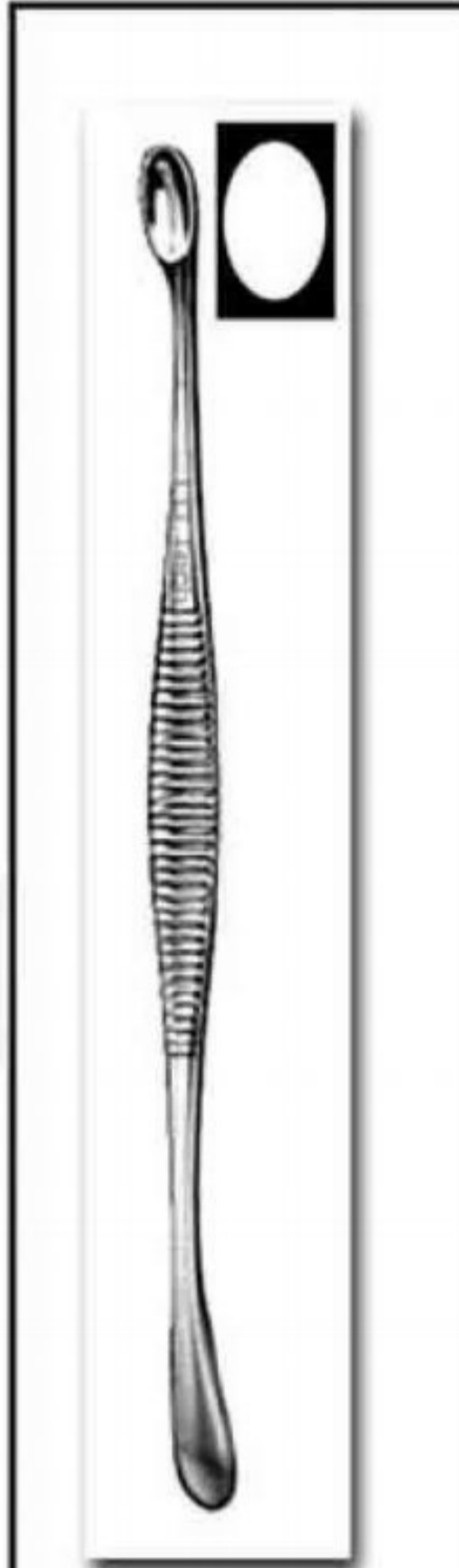

30-431-00 A / B / C
Volkmann
Bone Curette,
double-ended

Available in 3 sizes
(Length)
A: 12.5 cm / 5"
B: 14.5 cm / 5 3/4"
C: 17 cm / 6 3/4"

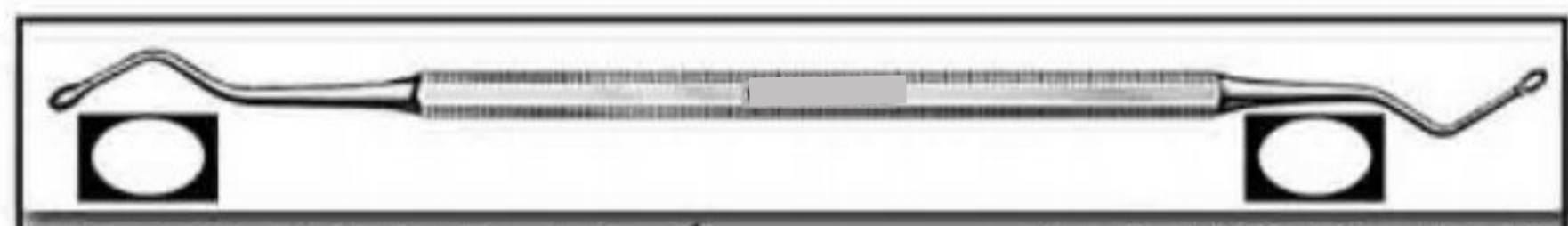

AJ-2361 A / B / C
Hemingway-Martin
Bone Curette, double-ended
18.5 cm / 7 1/4"
octagonal handle oval / oval

For 18cm:30-429-00 A / B / C (3 same order sets)
Hemingway Bone Curette, double-ended 18 cm/7"
octagonal handle oval / oval (For illustration see 12-374-18)

BONE CURETTES

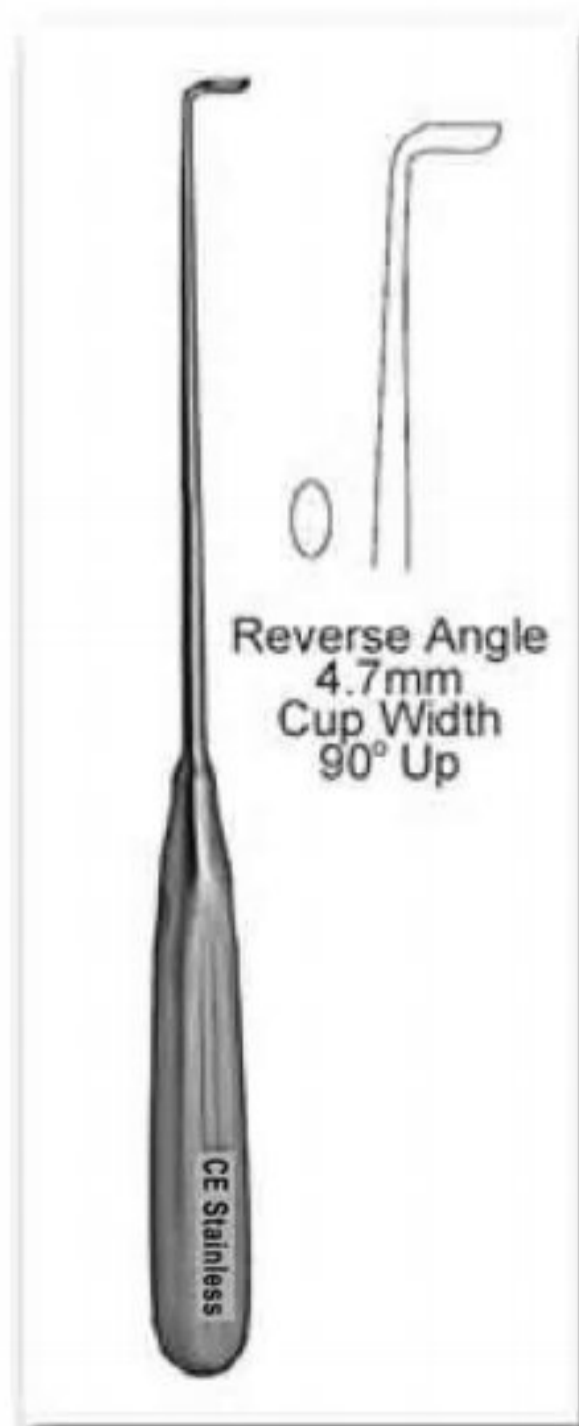
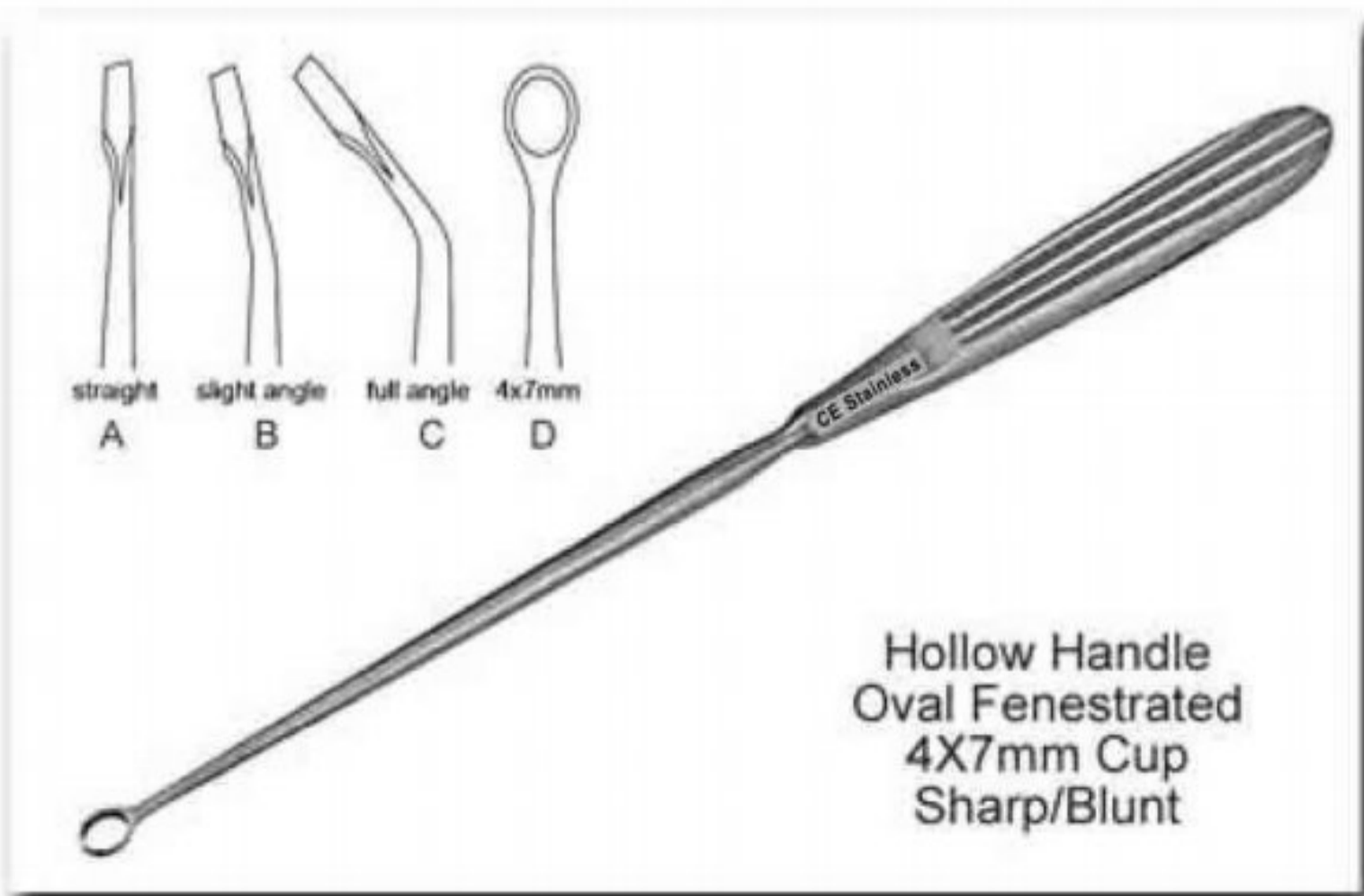
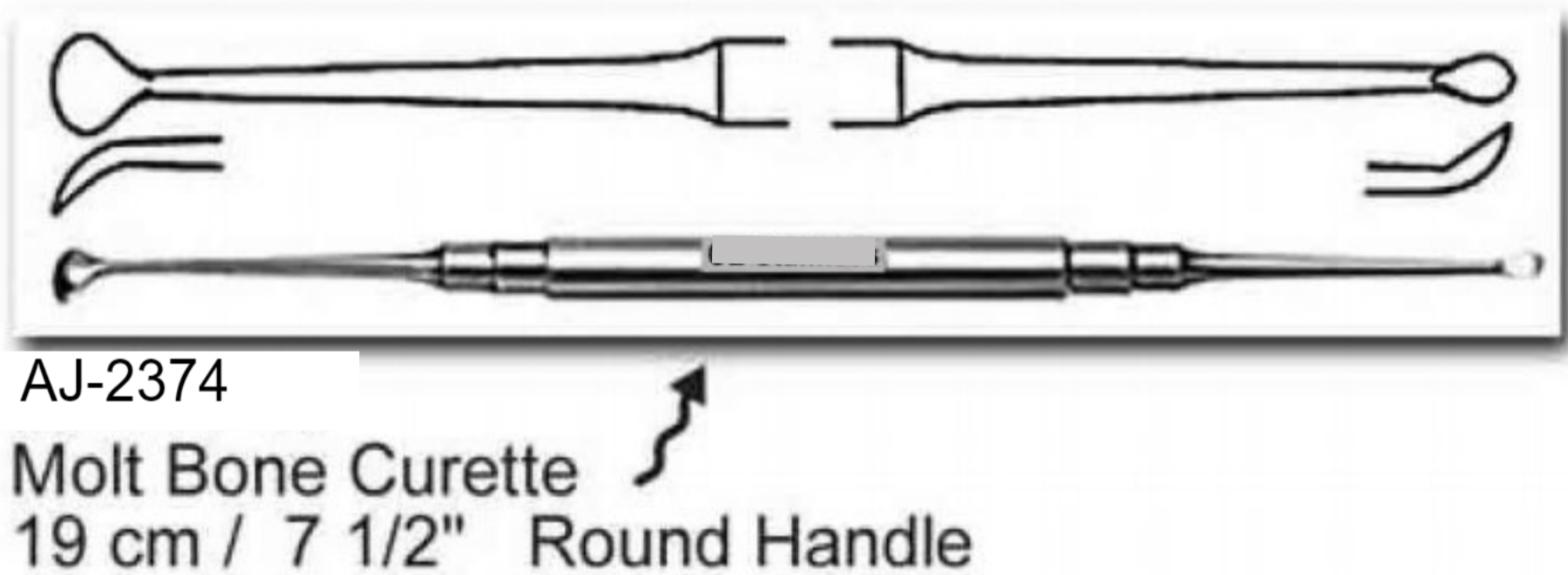
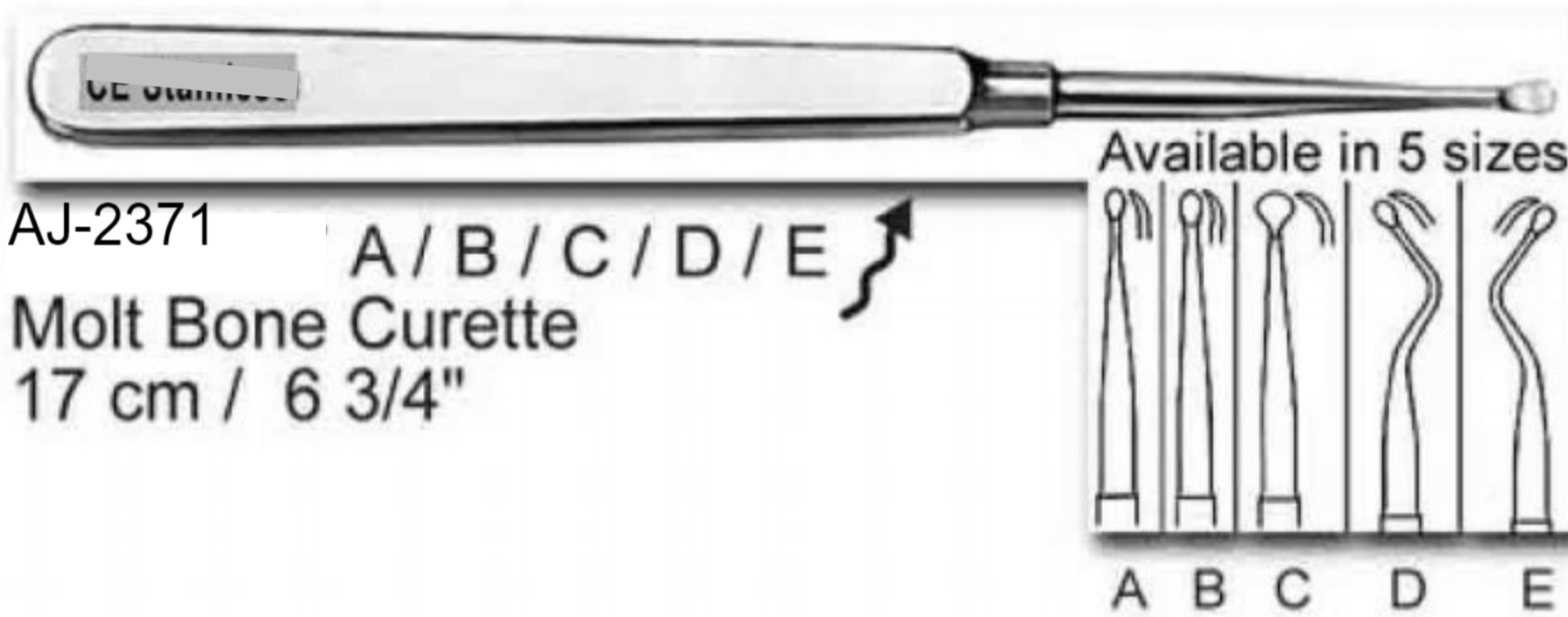
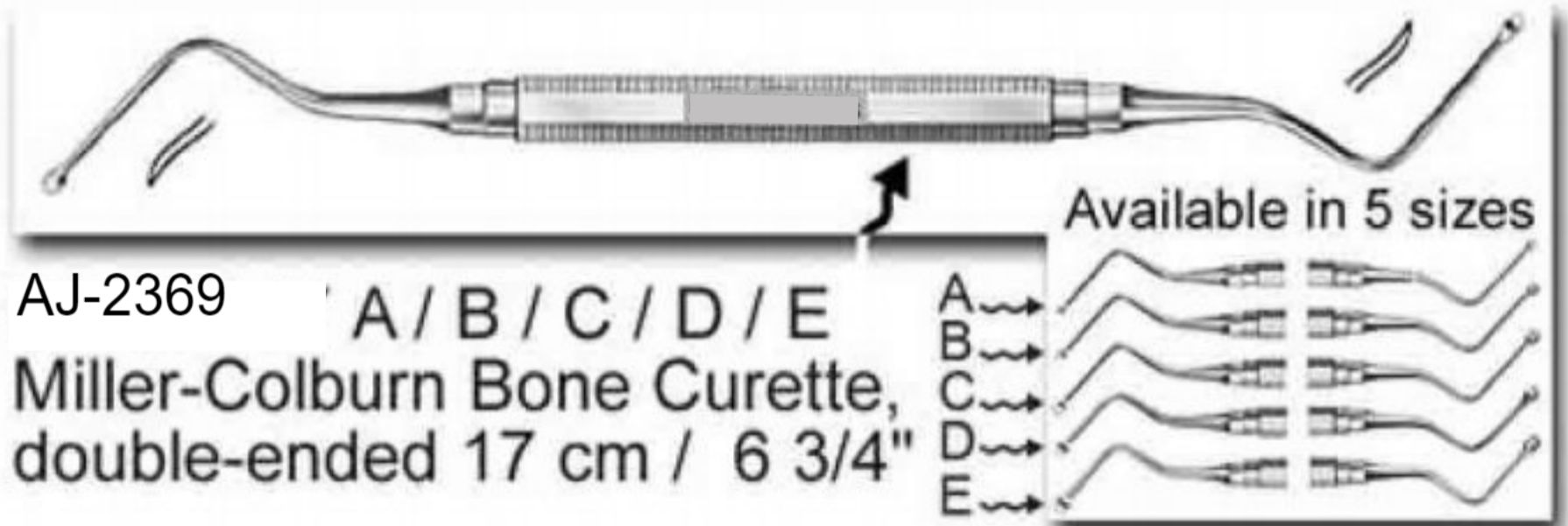
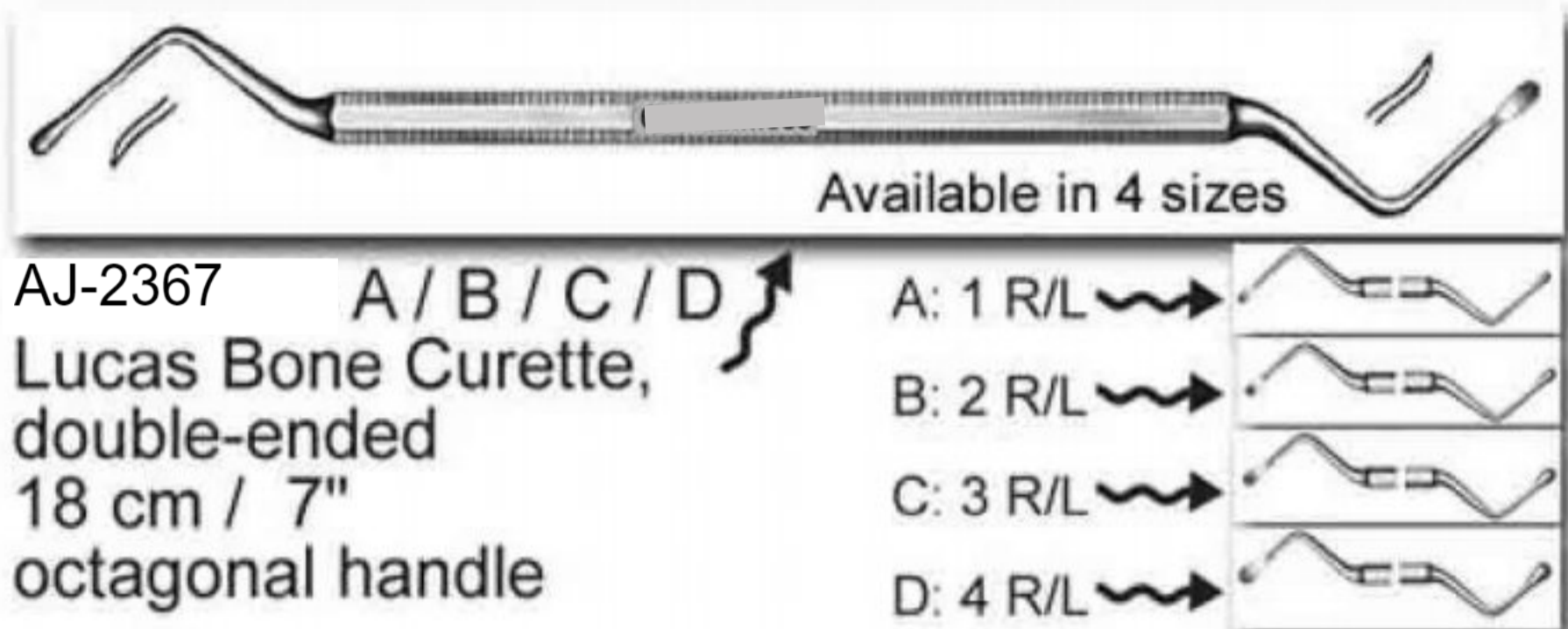
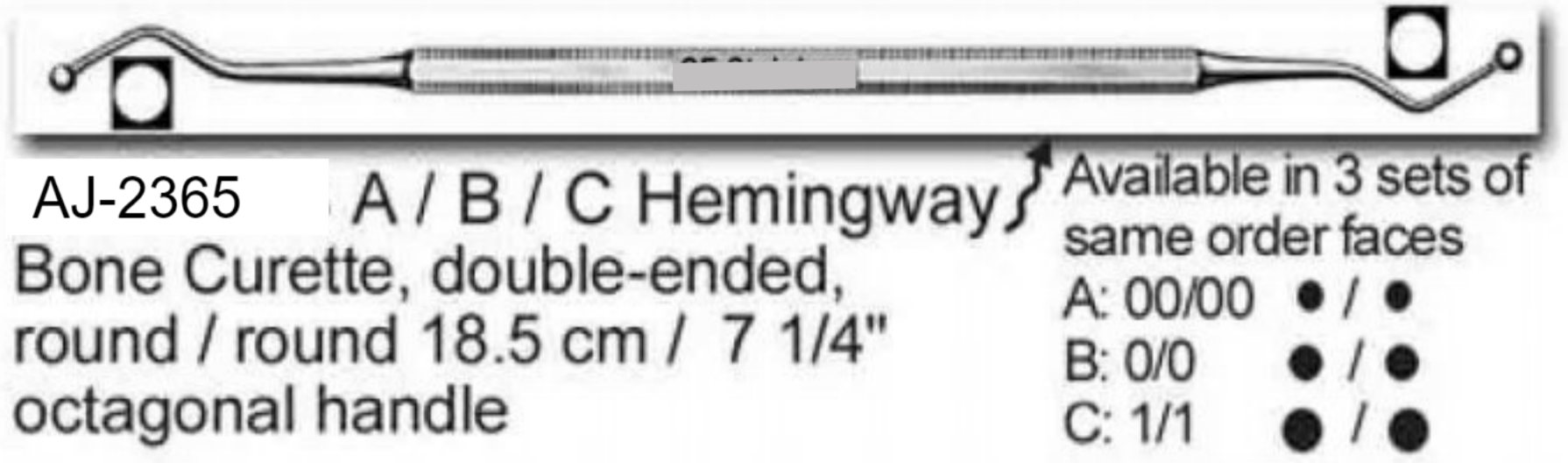
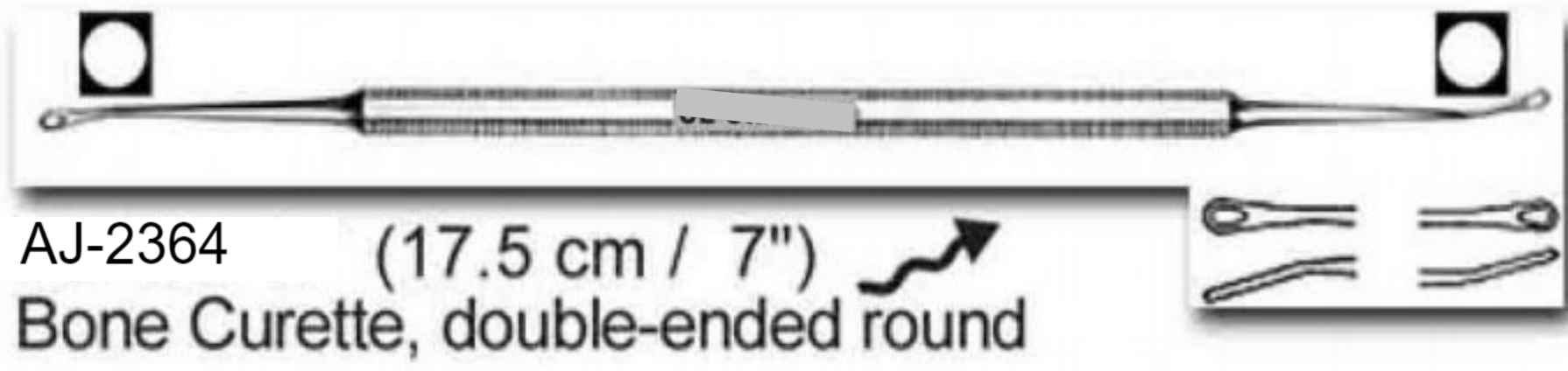

A: 25 cm / 10" #0 6mm Cup
 B: 25 cm / 10" #2 8mm Cup
 C: 26 cm / 10 1/2" #6 14mm Cup
 D: 28 cm / 11 1/2" #0 6mm Cup
 E: 28 cm / 11 1/2" #2 8mm Cup
 F: 30 cm / 12 1/2" #6 14mm Cup

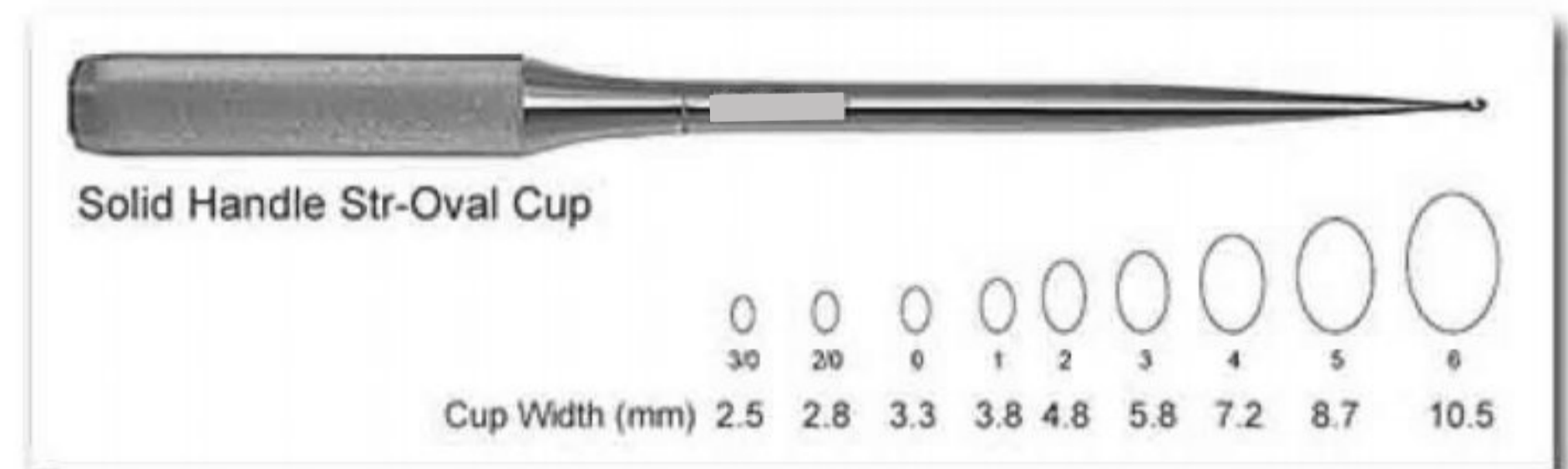
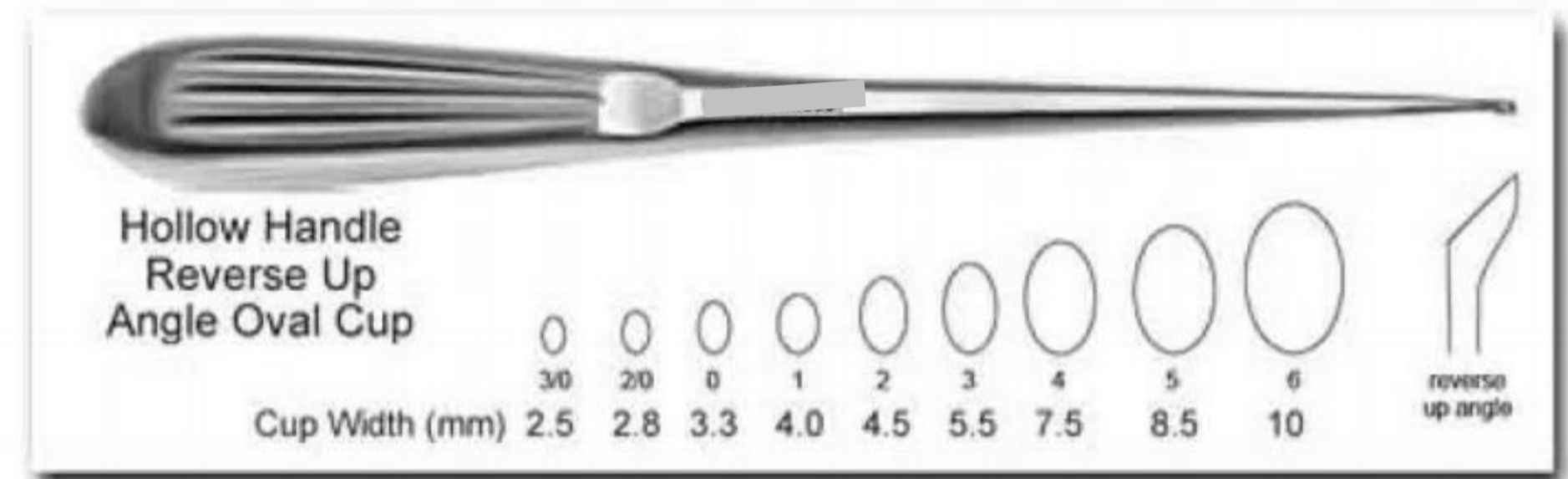
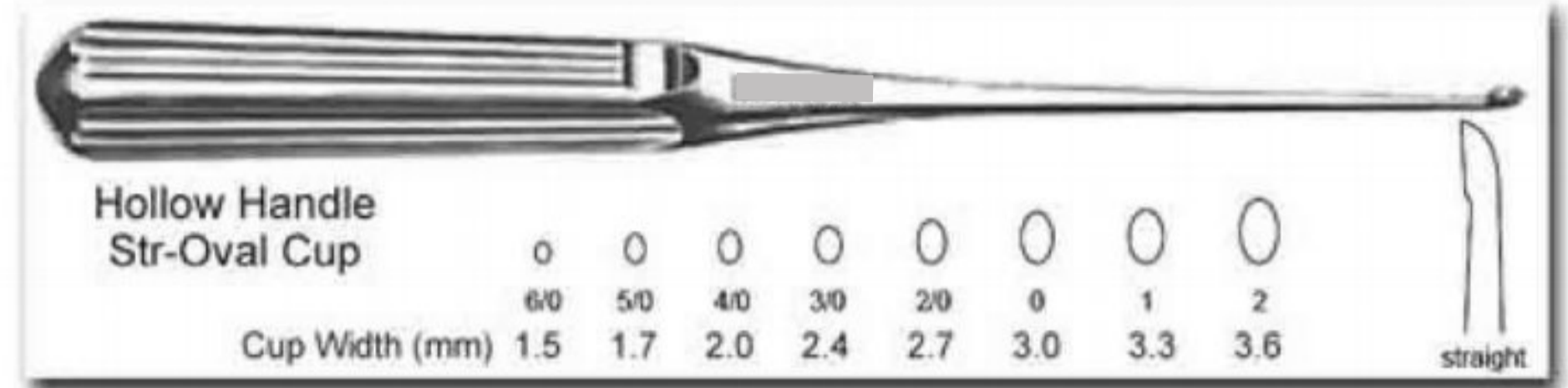
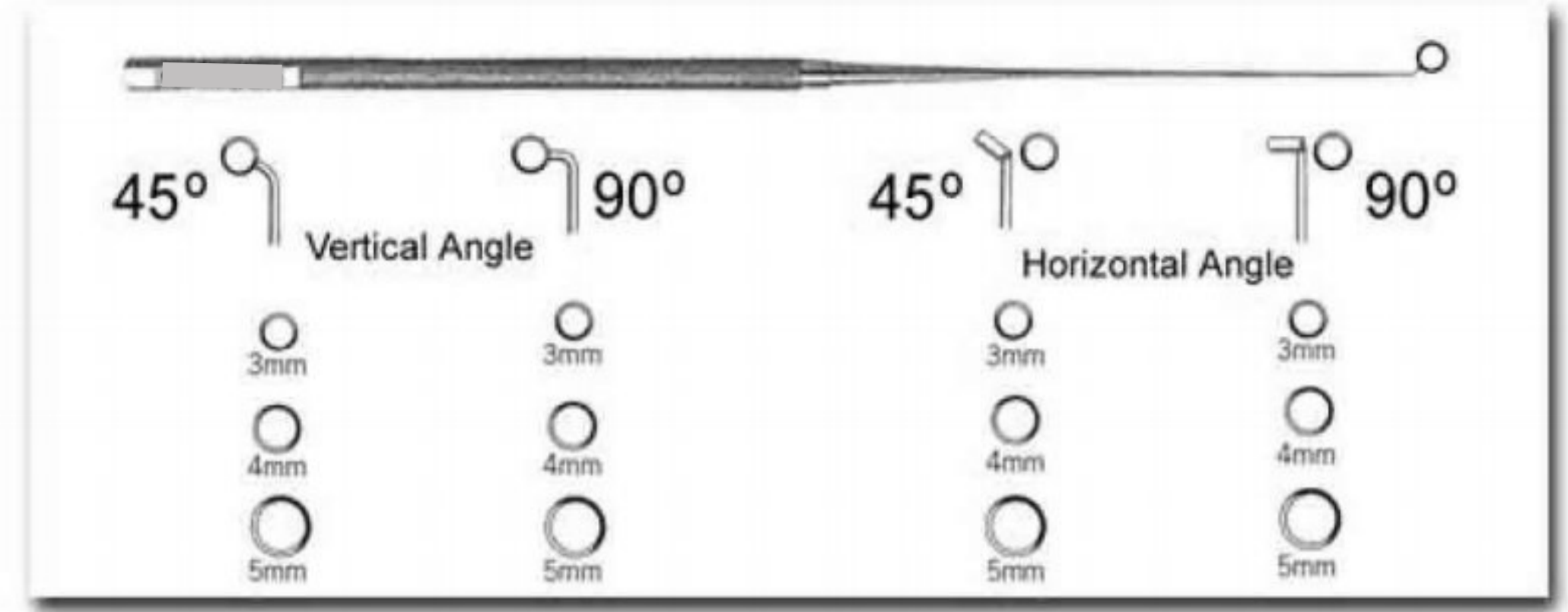

BONE CURETTES

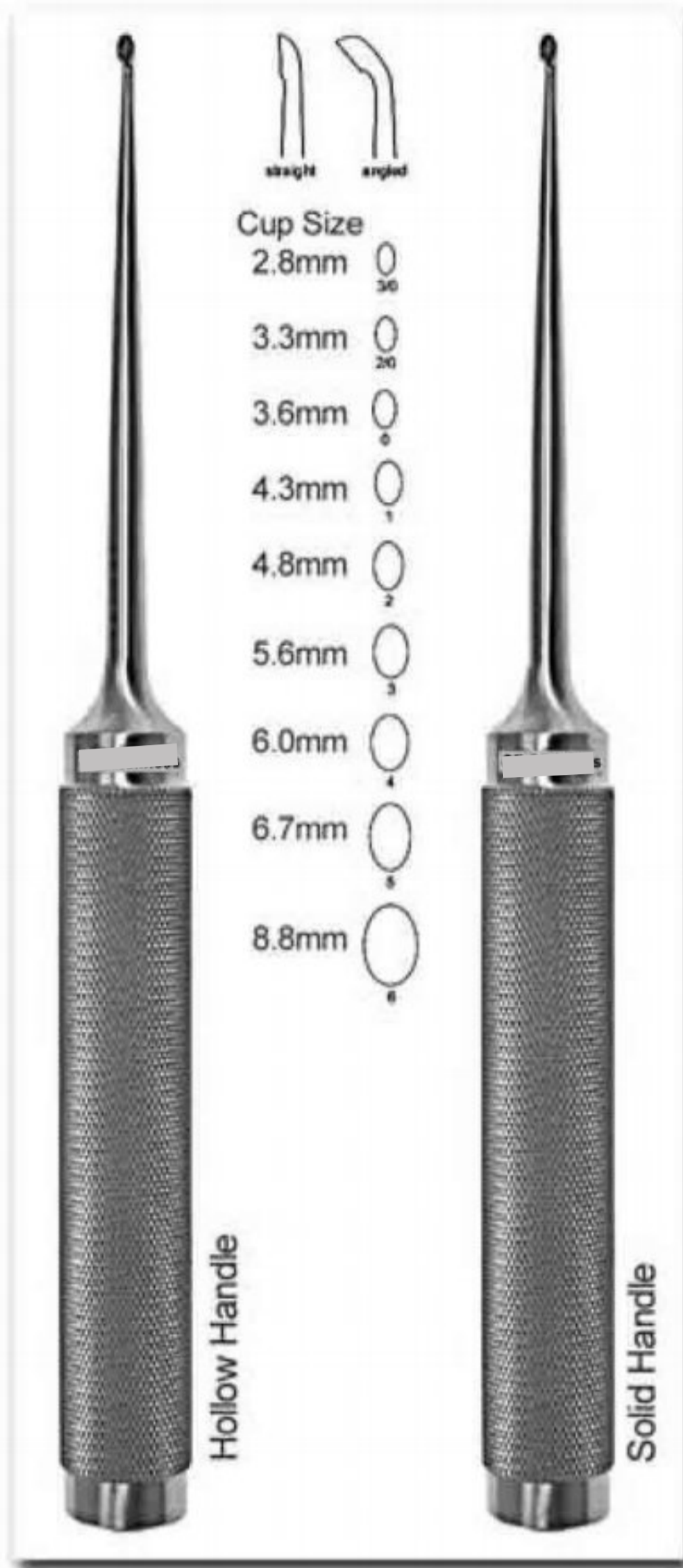

AJ-2379
Cobb Curette Oval Cups
28 cm / 11"



AJ-2380
Cobb Curette Oval Cups
28 cm / 11"

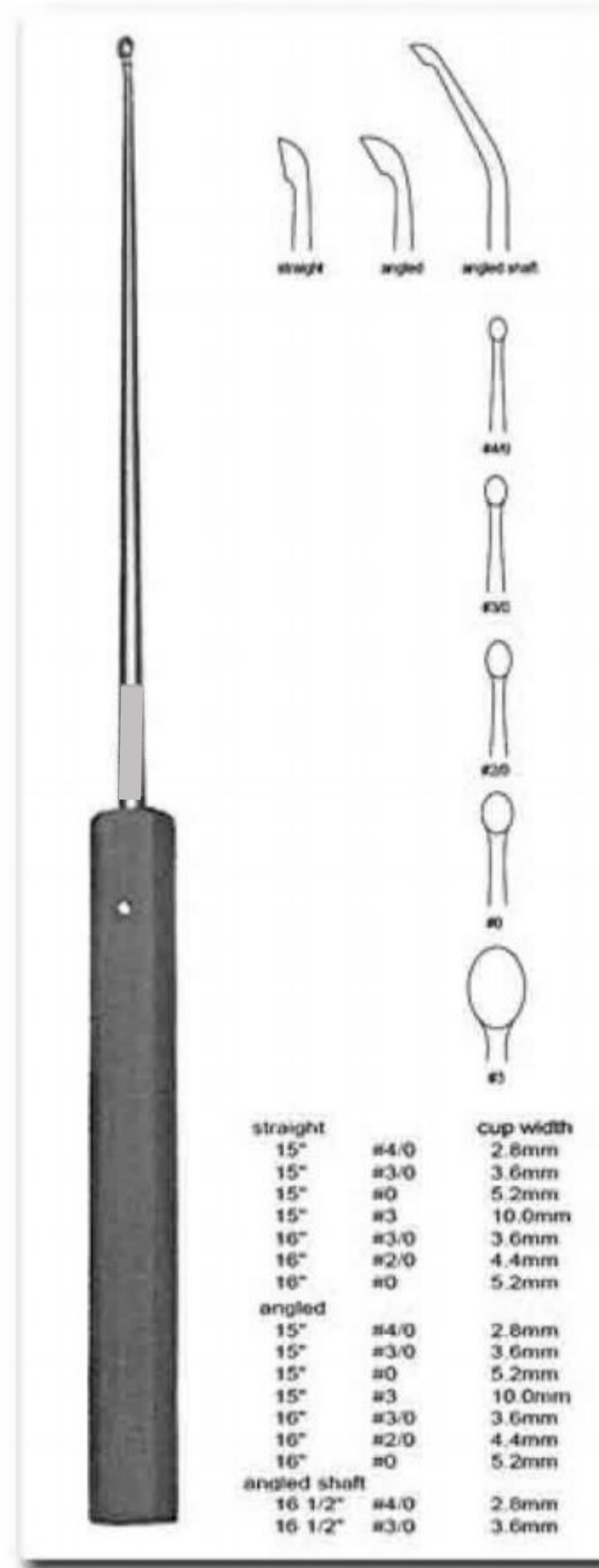

AJ-2381
Syptert Curette Long Delicate Shaft



AJ-2382
Cone Ring Curette
23 cm / 9"



- A: Straight 8mm Sharp/Blunt
- B: Straight 11mm Sharp/Blunt
- C: Angled 8mm Sharp/Sharp
- D: Angled 11mm Sharp/Sharp
- E: Angled 8mm Sharp/Sharp Right Cvd
- F: Angled 11mm Sharp/Sharp Right Cvd
- G: Angled 8mm Sharp/Sharp Left Cvd
- H: Angled 11mm Sharp/Sharp Left Cvd

AJ-2383 Zielke Ring Curette 34 cm / 13 1/2" TEFLON Handle

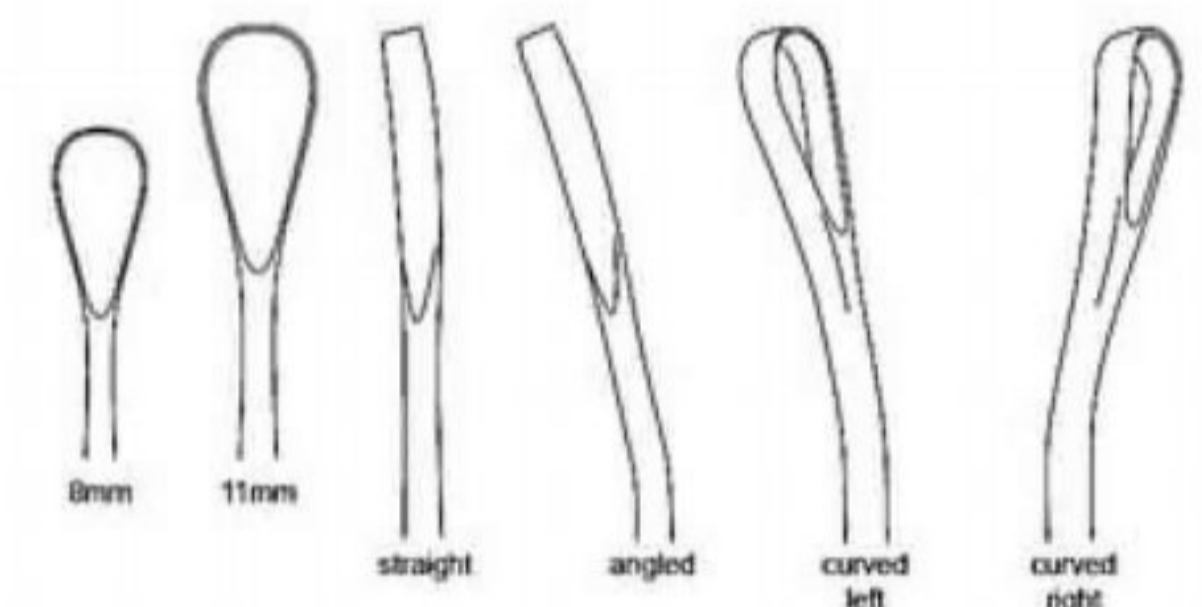

AJ-2384 Cone Ring Curette Endoscopic Fibre Handle

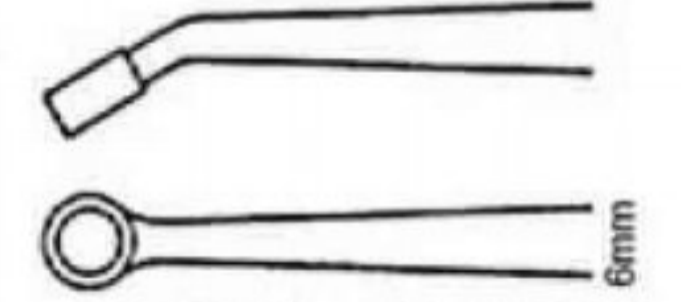

20" Angled 30°
6mm Diameter
3 1/2" Tip Length
10" Shaft Length
6 1/2" Handle Length
.45" (11.5mm)
Shaft Diameter

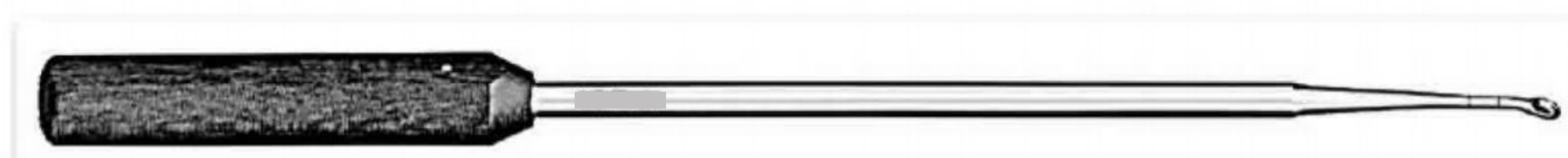
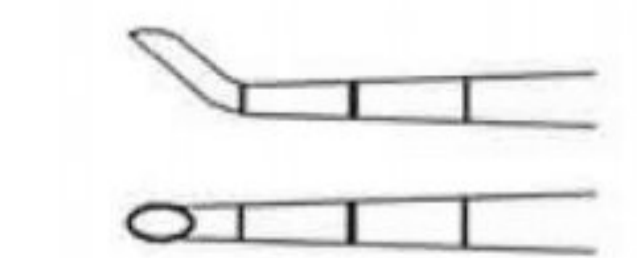

AJ-2385 Epstein Curette Endoscopic Fibre Handle

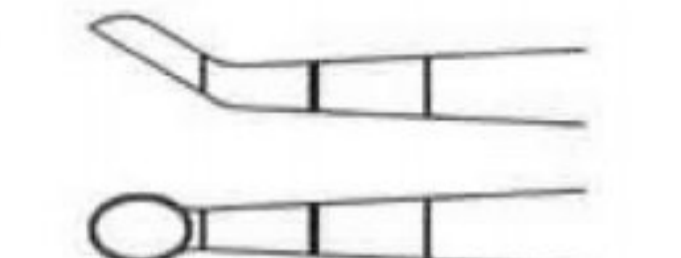

20" Reverse
Angled 30°
6mm x 9mm cup
3 1/2" Tip Length
10" Shaft Length
6 1/2" Handle Length
.45 (7.2mm)
Shaft Diameter

ELEVATORS

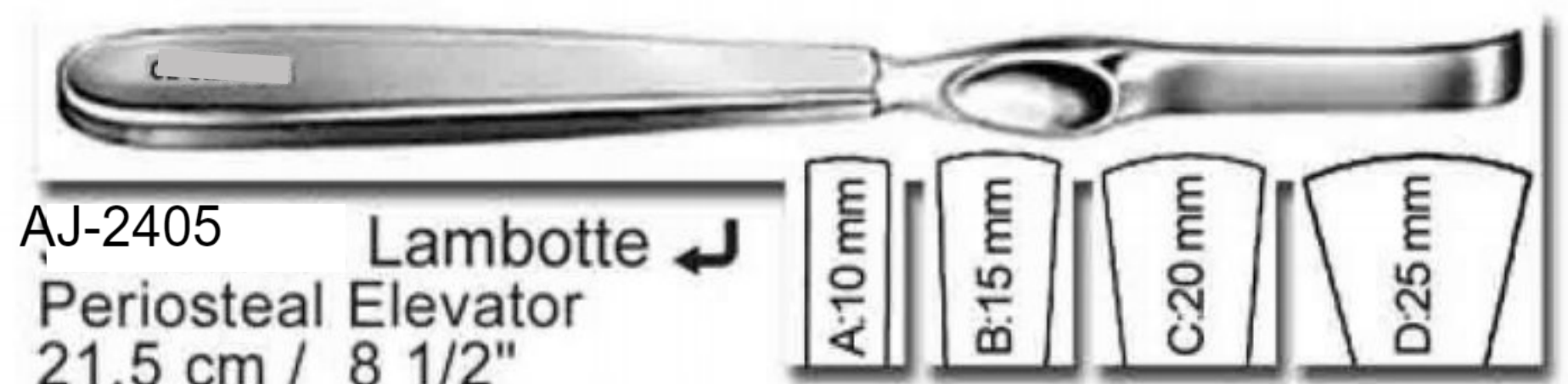
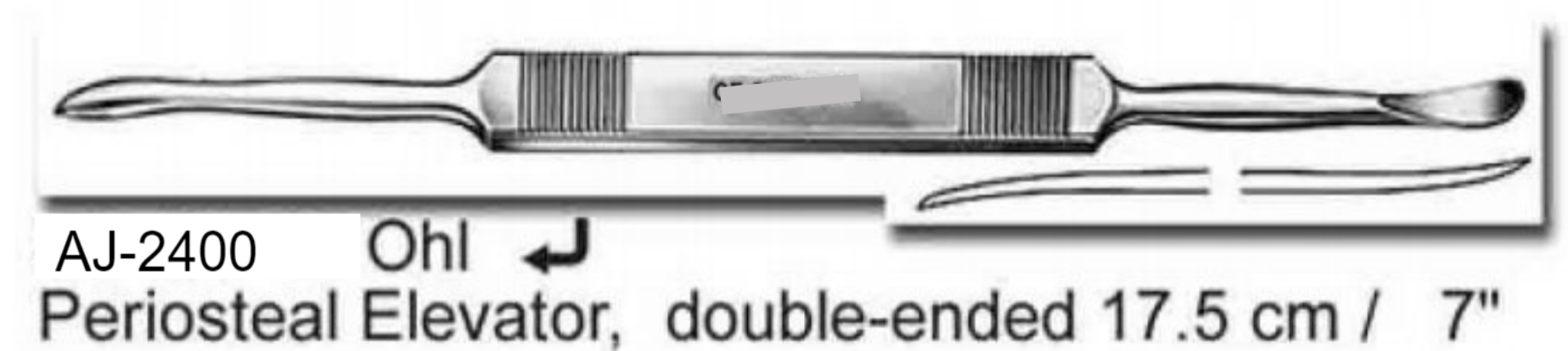
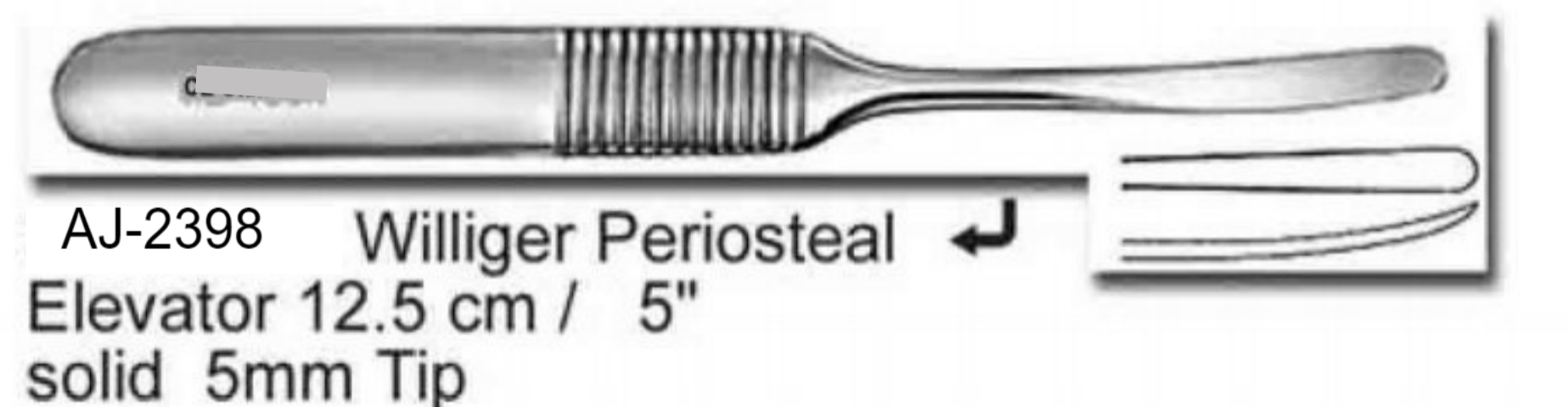
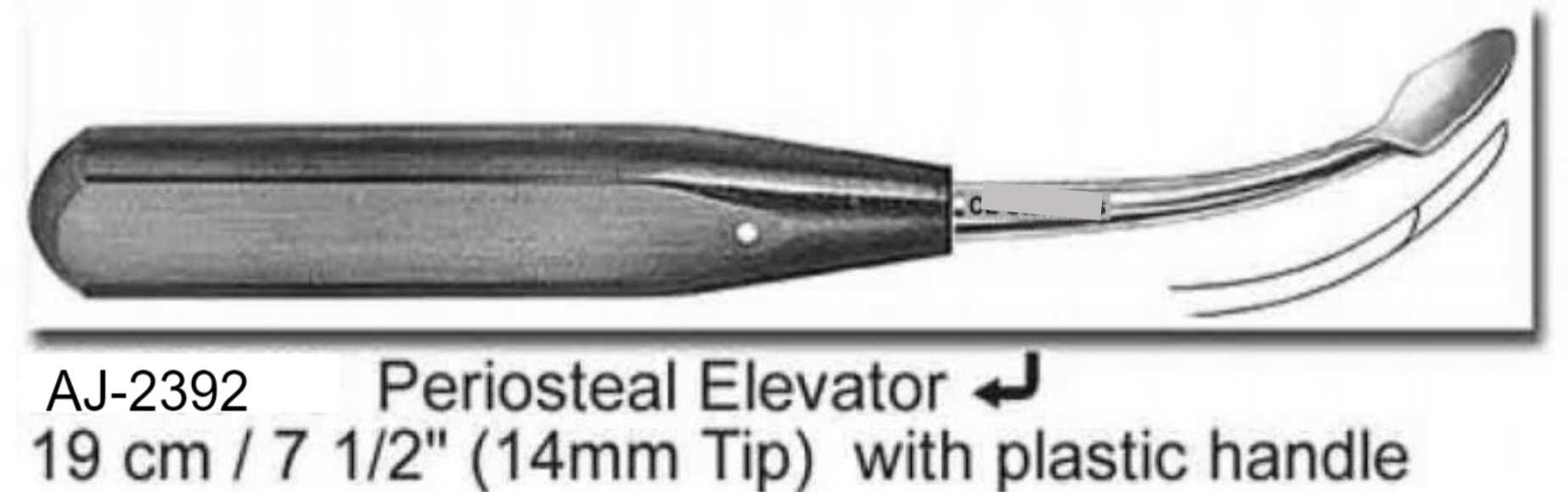
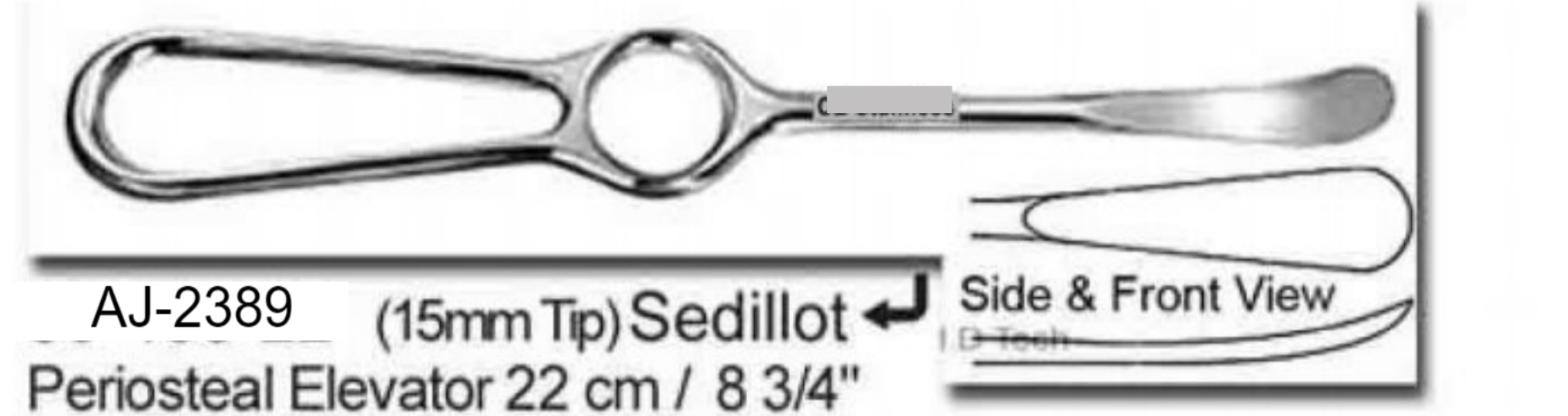
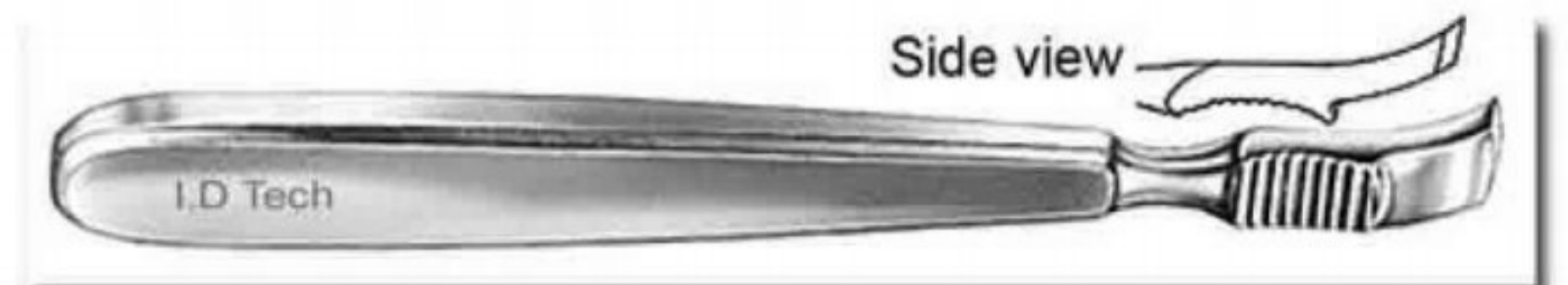
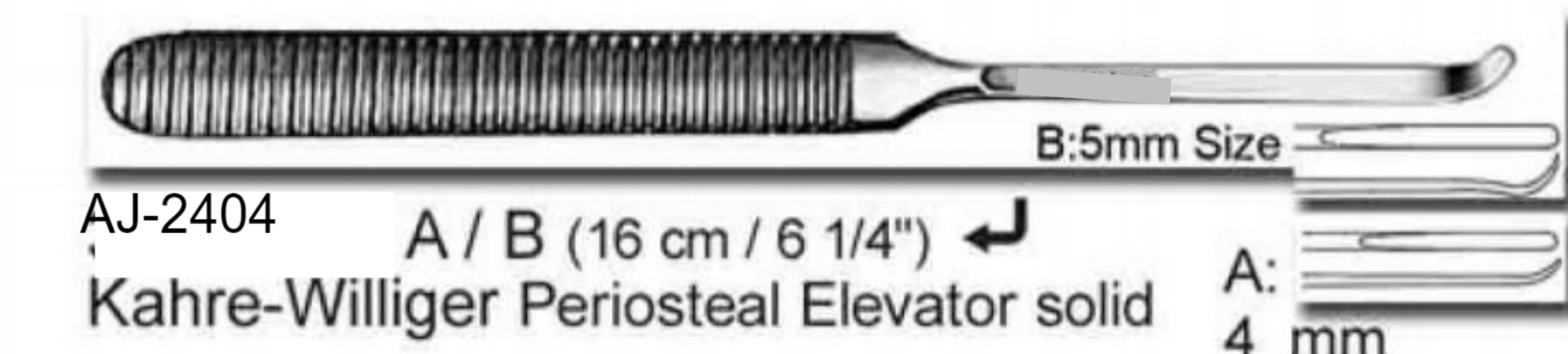
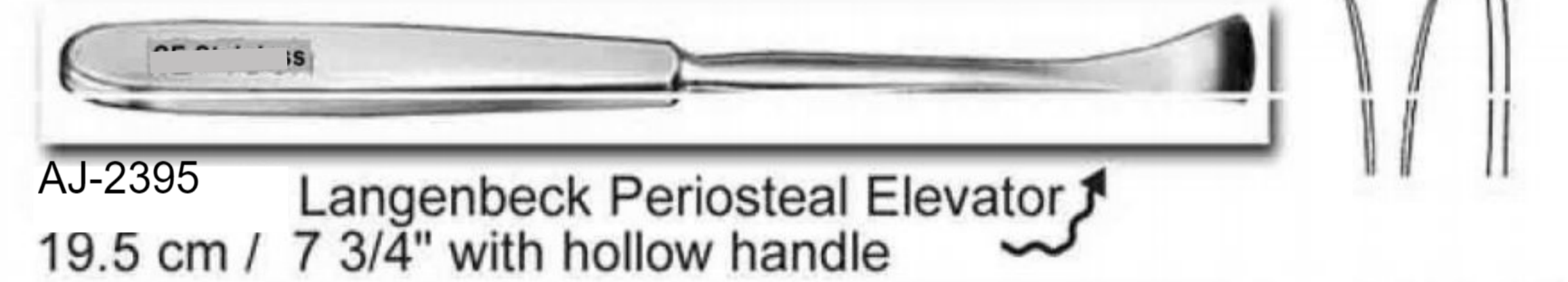
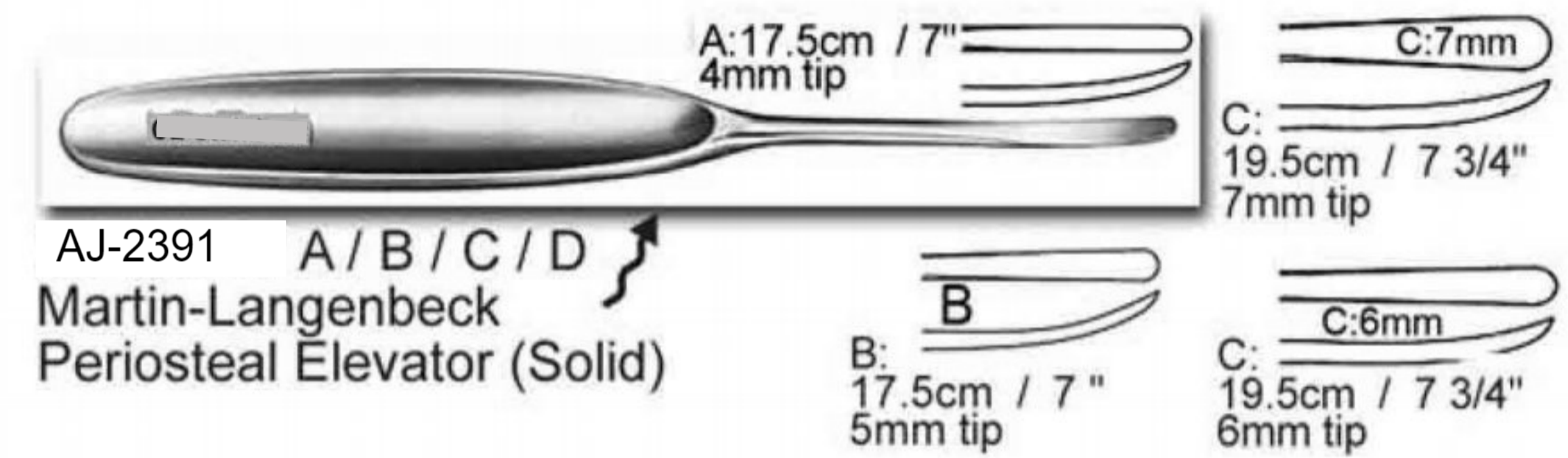
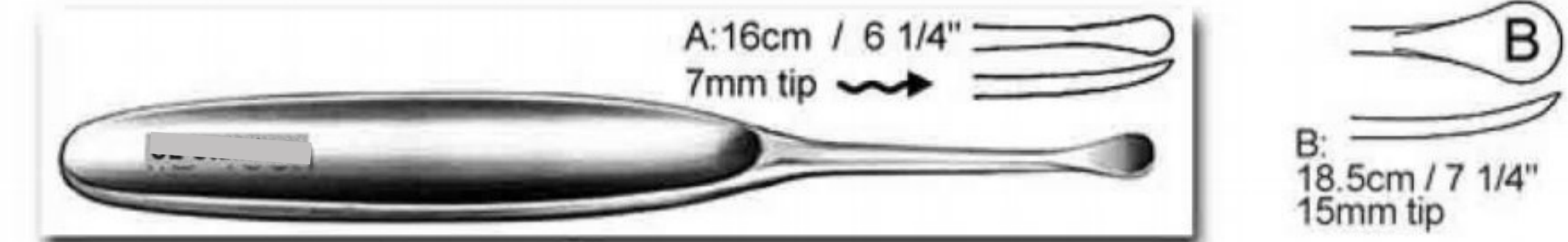
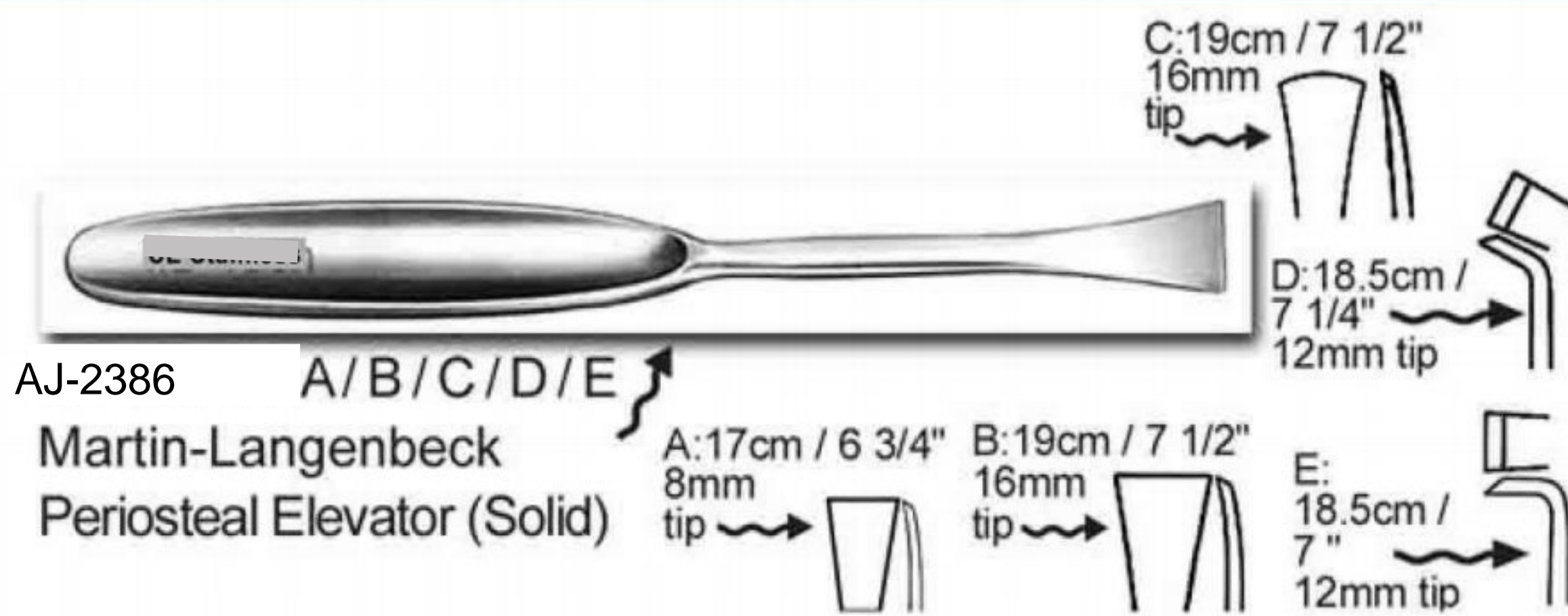

ELEVATORS

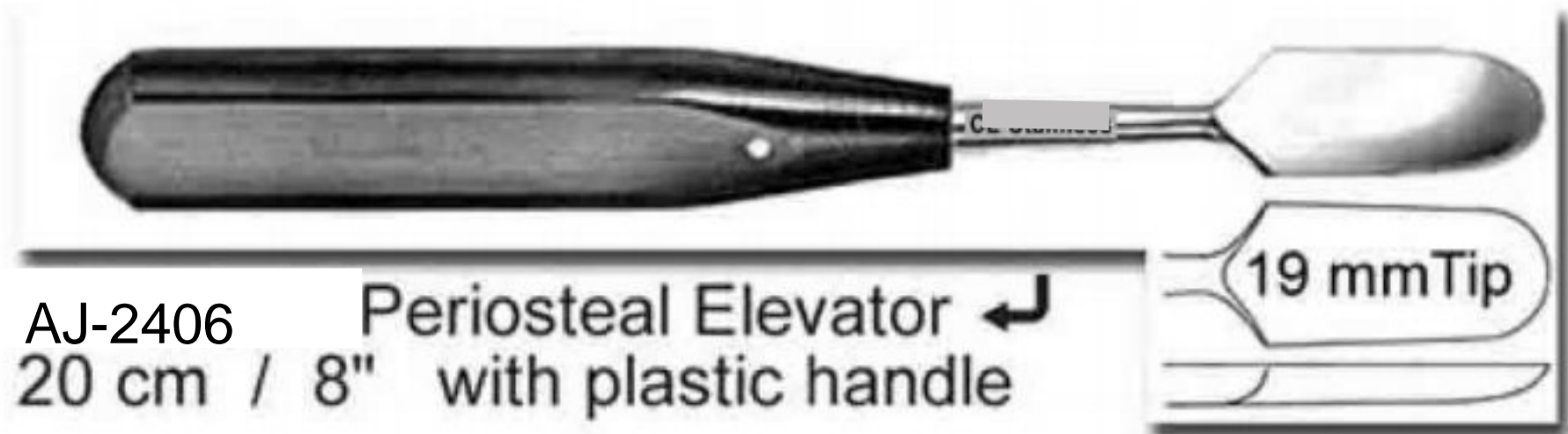

AJ-2406 Periosteal Elevator
20 cm / 8" with plastic handle



AJ-2408 A / B Periosteal Elevator
17 cm / 6 3/4" with hollow handle

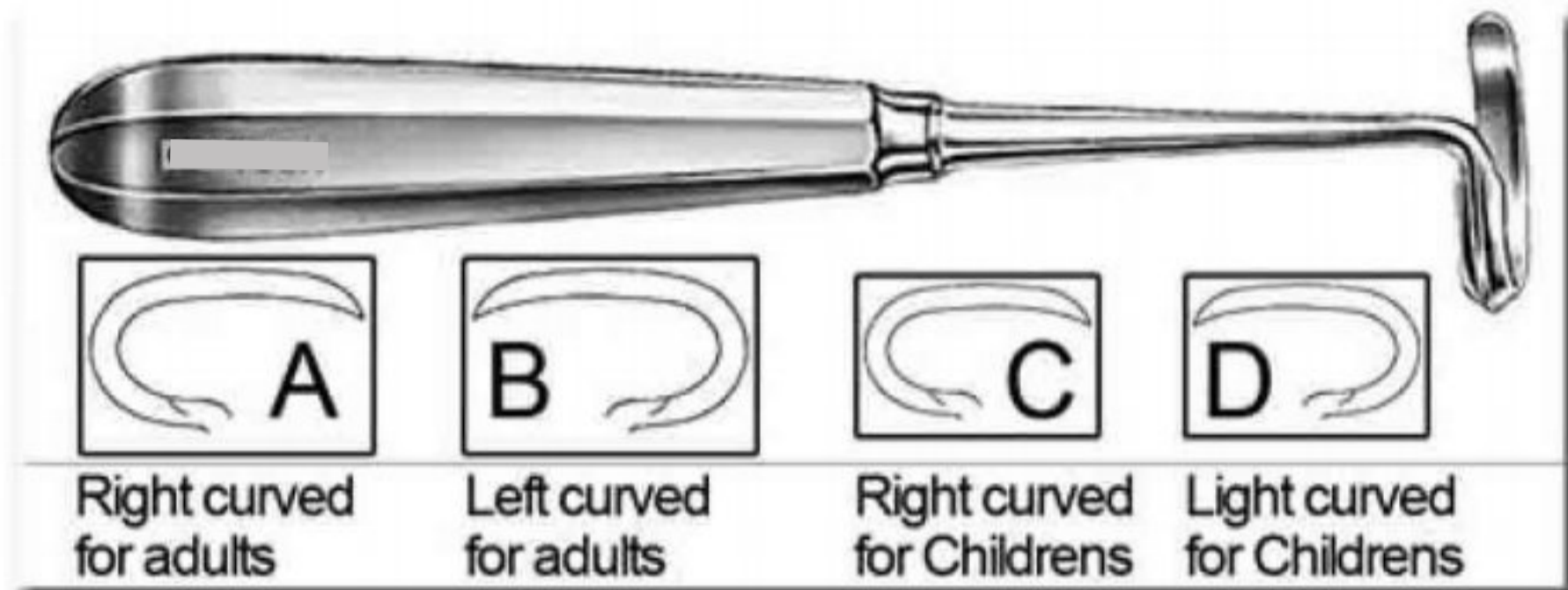

AJ-2410 A / B / C / D Doyen Rib Raspatory
17.5 cm / 7" Rib Raspatories with hollow handle

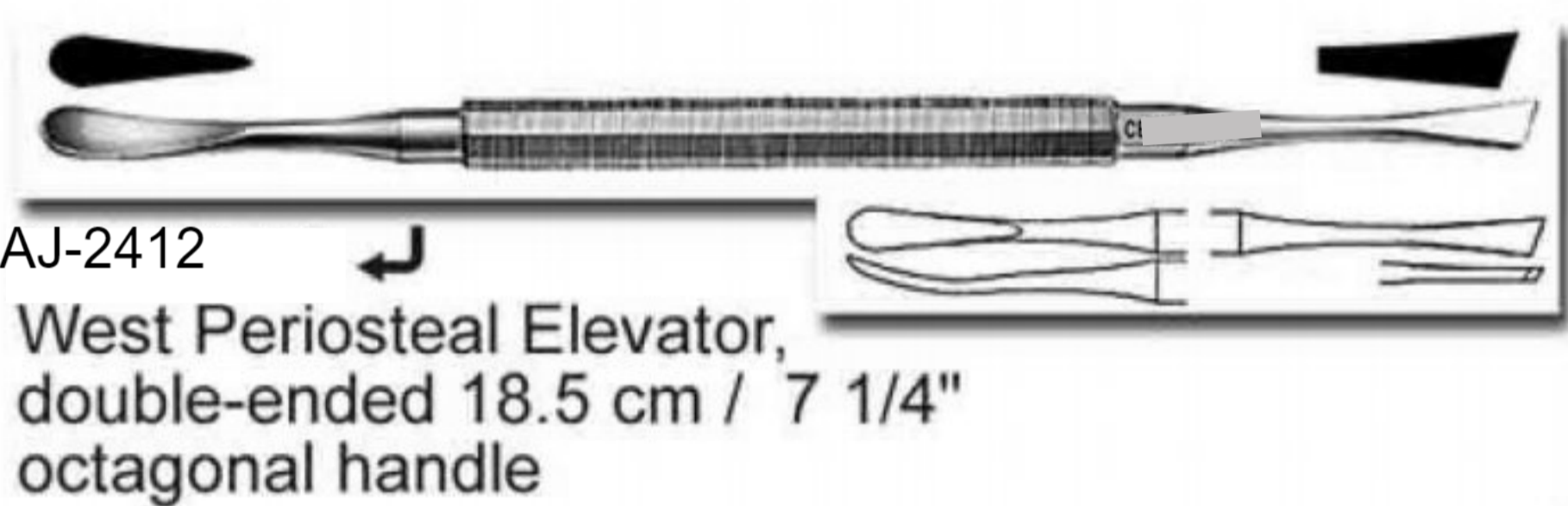

AJ-2412 West Periosteal Elevator,
double-ended 18.5 cm / 7 1/4"
octagonal handle

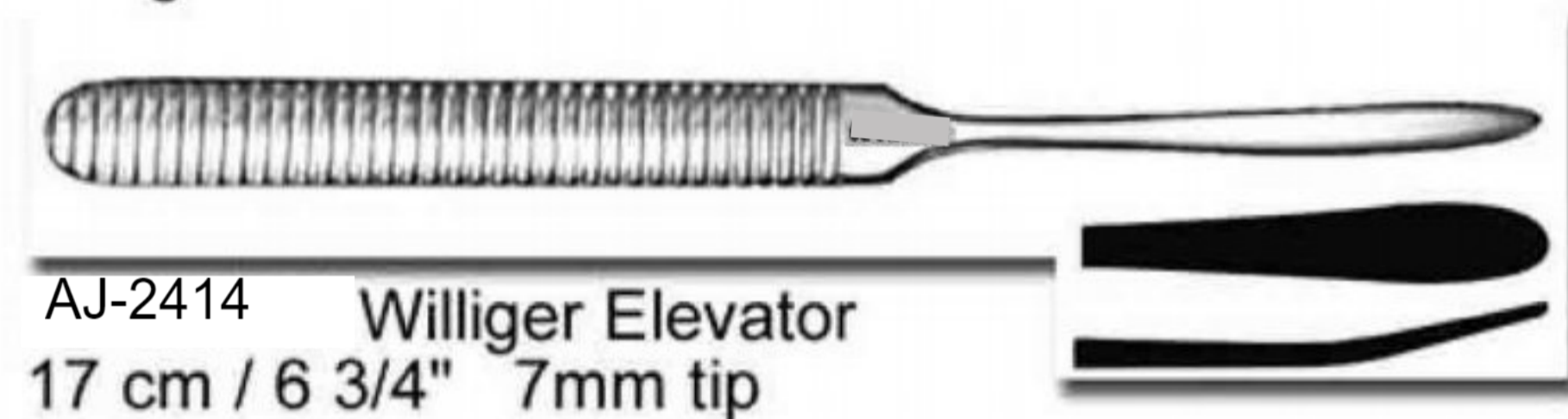

AJ-2414 Williger Elevator
17 cm / 6 3/4" 7mm tip

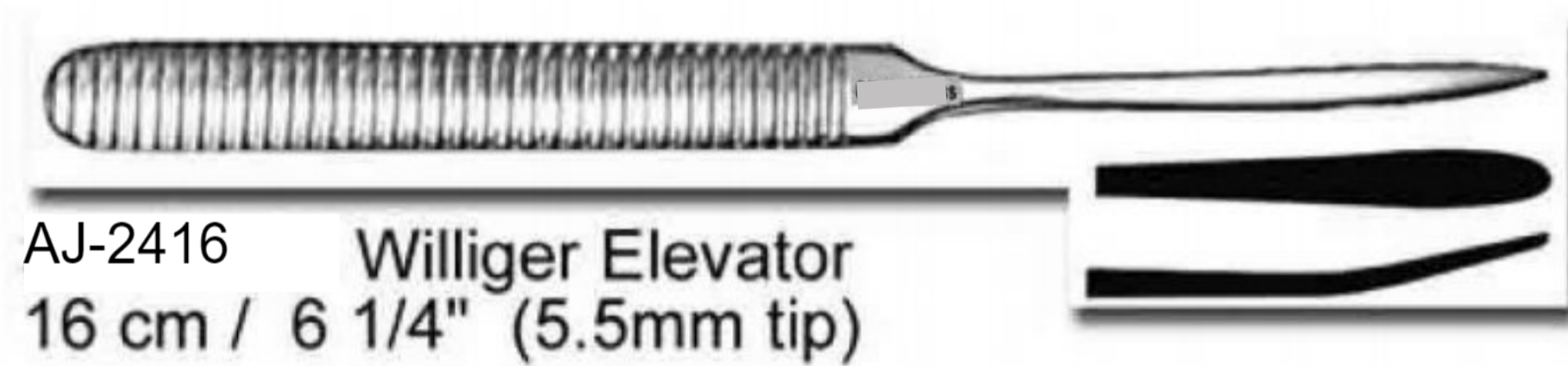

AJ-2416 Williger Elevator
16 cm / 6 1/4" (5.5mm tip)

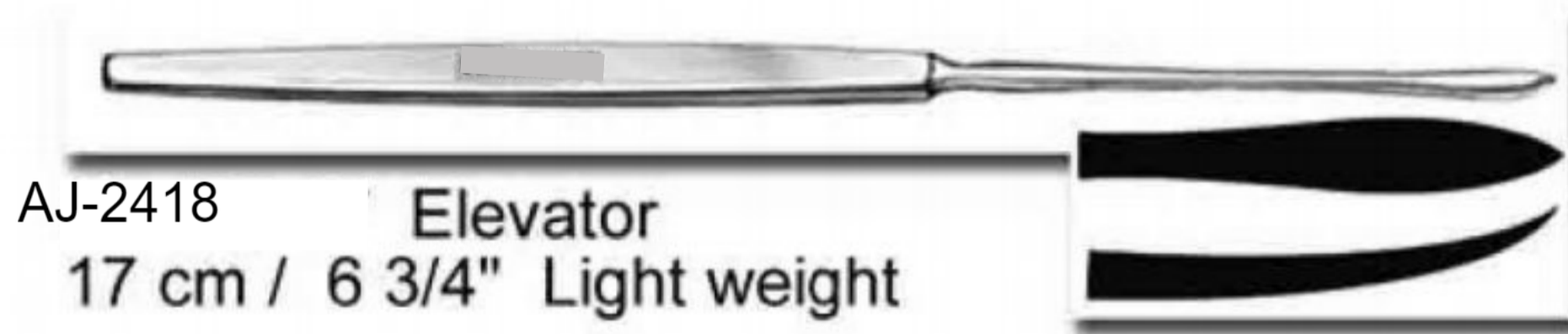

AJ-2418 Elevator
17 cm / 6 3/4" Light weight

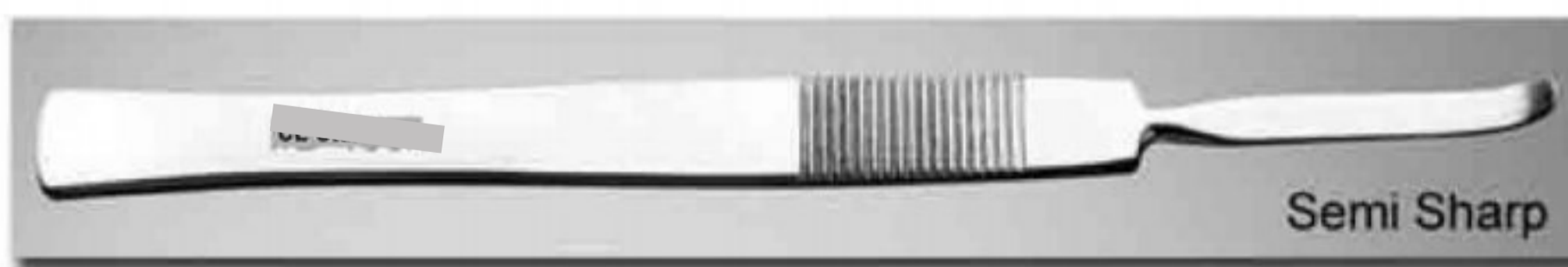

AJ-2420 McKenty Elevator
14 cm / 5 1/2" 4mm / 5mm

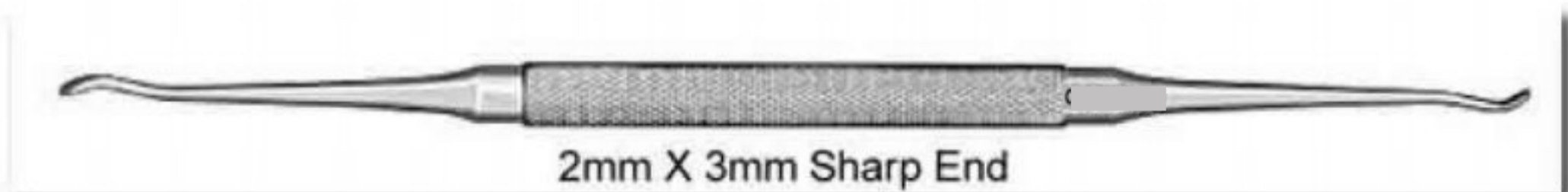

AJ-2422 Kleinert Kutz
Elevator 14 cm / 5 1/2" 2mm X 3mm Sharp End



AJ-2424 Penfield Elevator Endoscopic
38 cm / 15" 5mm Semi Sharp / 1X10mm Blunt Hook

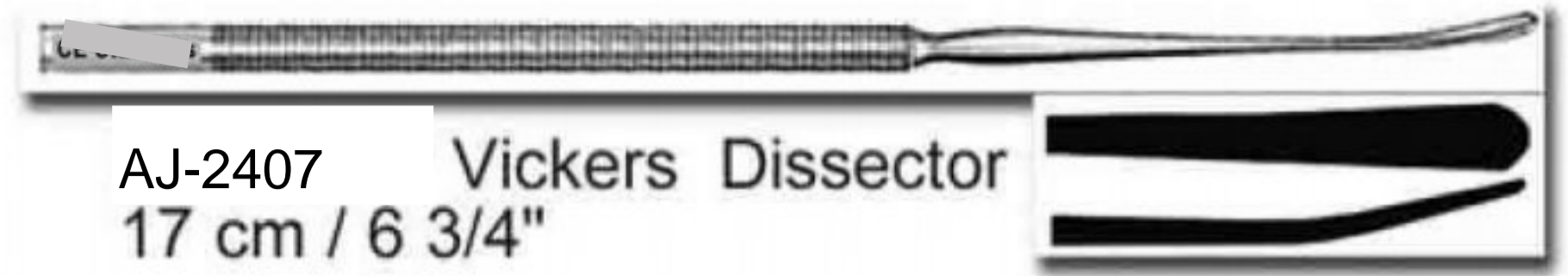

AJ-2407 Vickers Dissector
17 cm / 6 3/4"

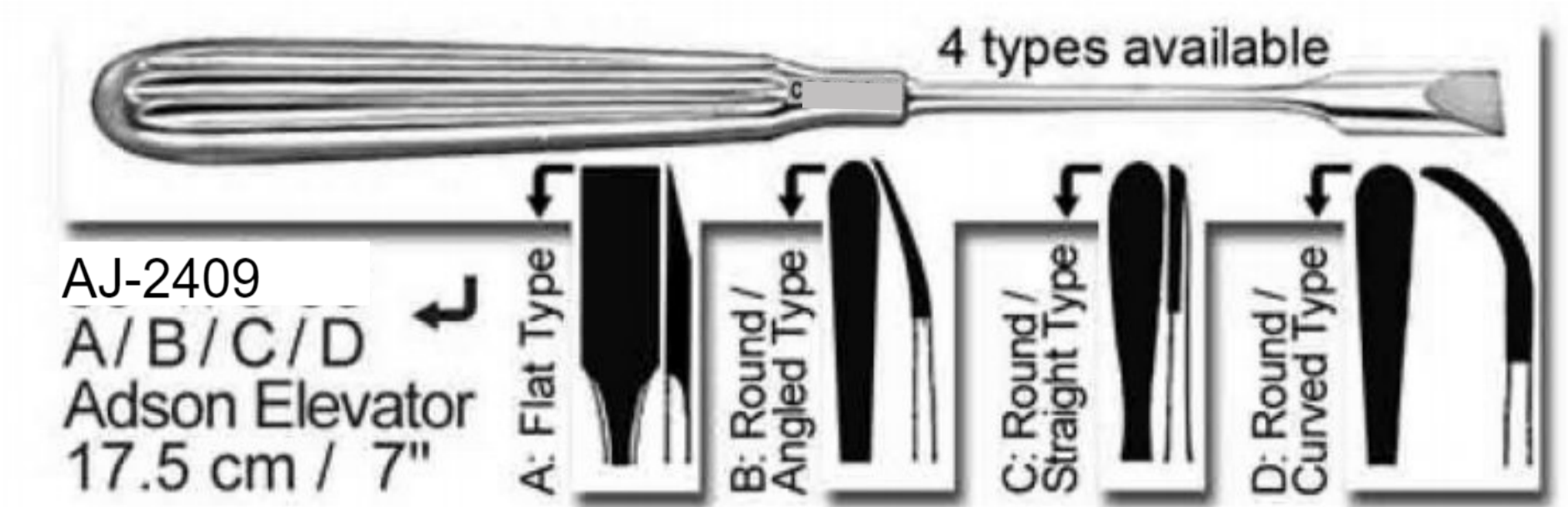

AJ-2409 A/B/C/D Adson Elevator
17.5 cm / 7"

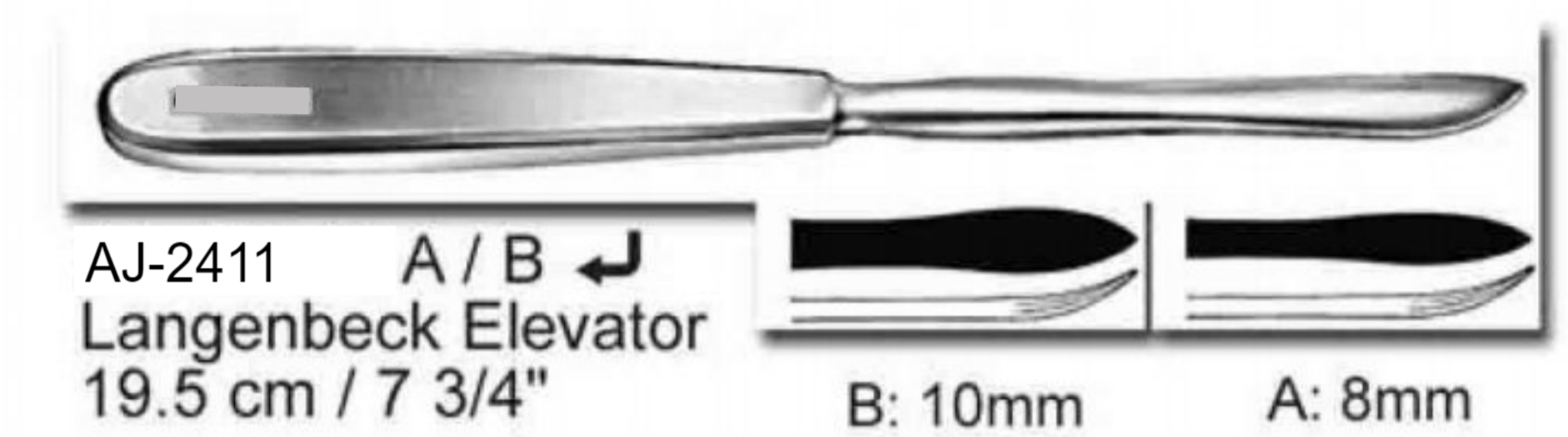

AJ-2411 A / B Langenbeck Elevator
19.5 cm / 7 3/4"

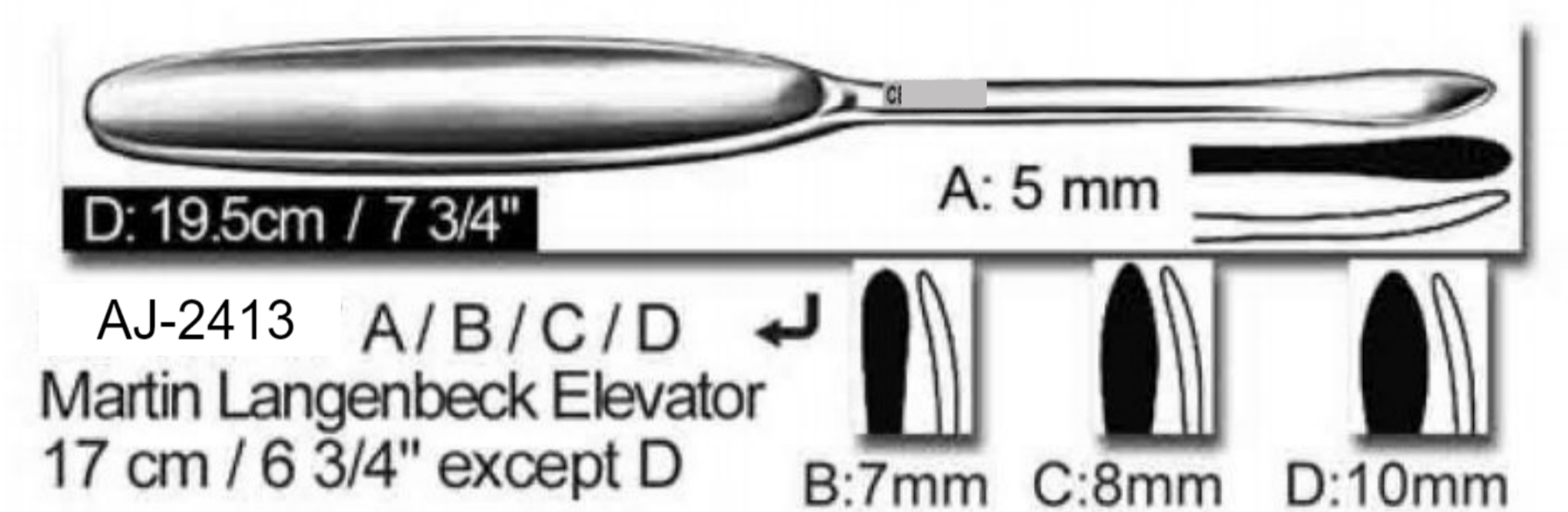

AJ-2413 A/B/C/D Martin Langenbeck Elevator
17 cm / 6 3/4" except D

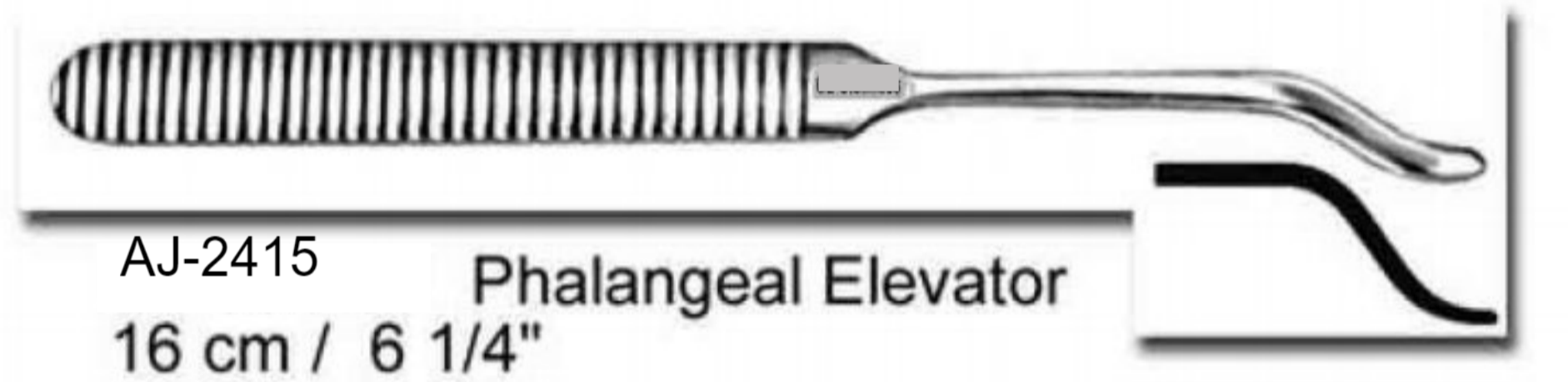

AJ-2415 Phalangeal Elevator
16 cm / 6 1/4"

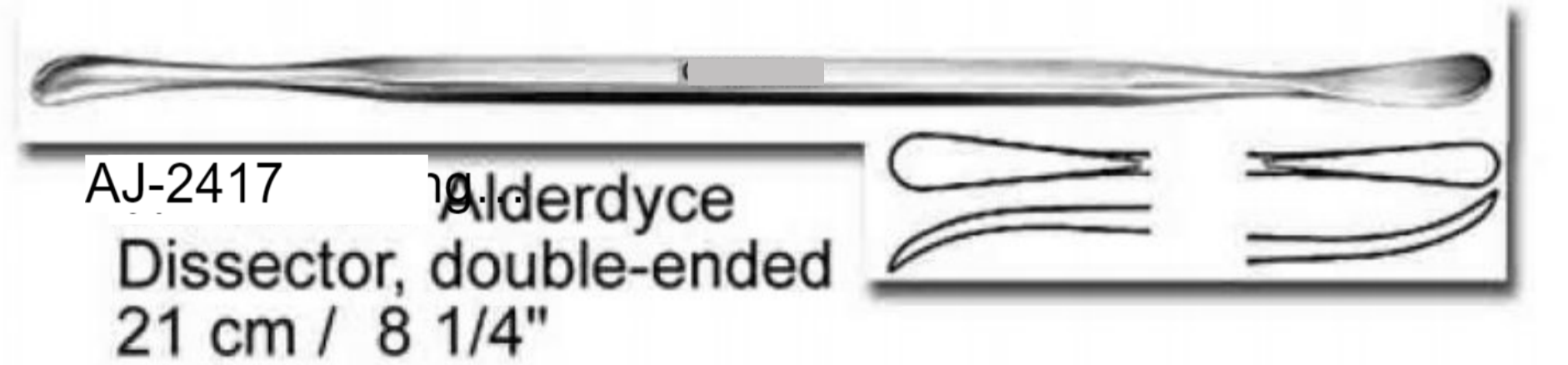

AJ-2417 Alderdyce Dissector,
double-ended 21 cm / 8 1/4"

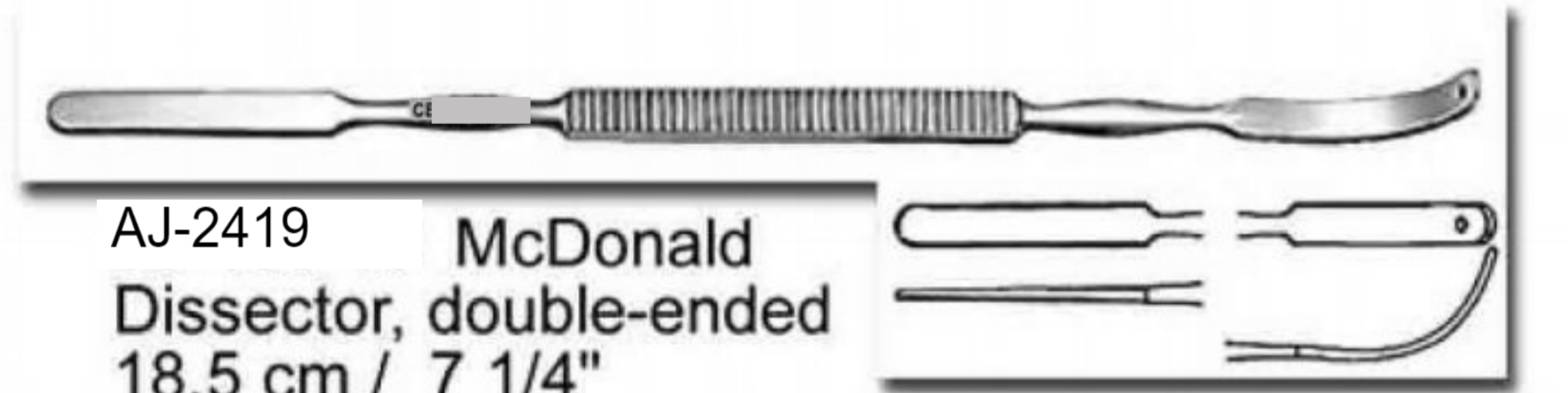

AJ-2419 McDonald Dissector,
double-ended 18.5 cm / 7 1/4"

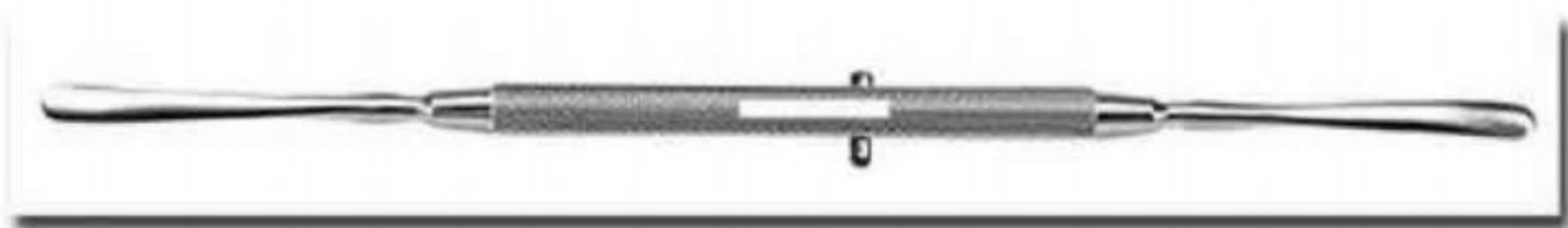

AJ-2421 Freer Elevator
19 cm / 7 1/2"



AJ-2423 Smithwick Hook and Dissector
30 cm / 12" 5mm Semi Sharp / 1X10mm Blunt Hook

ELEVATORS

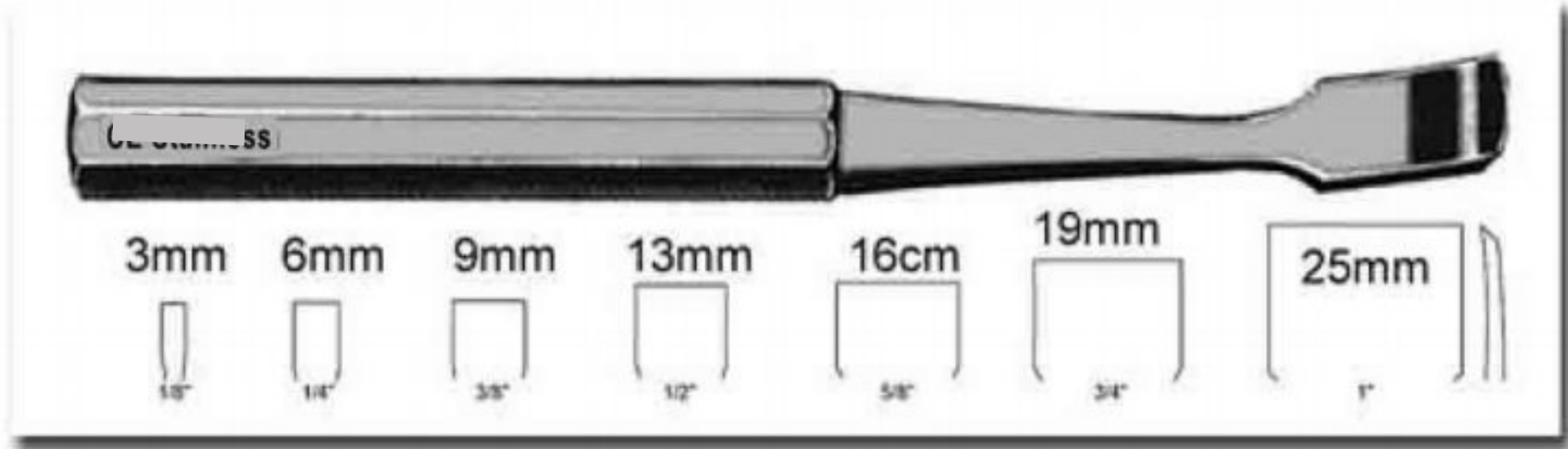

AJ-2425 Key Elevator 19 cm / 7 1/2" Sharp Edge



AJ-2426 Sayre Elevator 16 cm / 6 1/2"
A: Sharp / Blunt B: Blunt/ Blunt

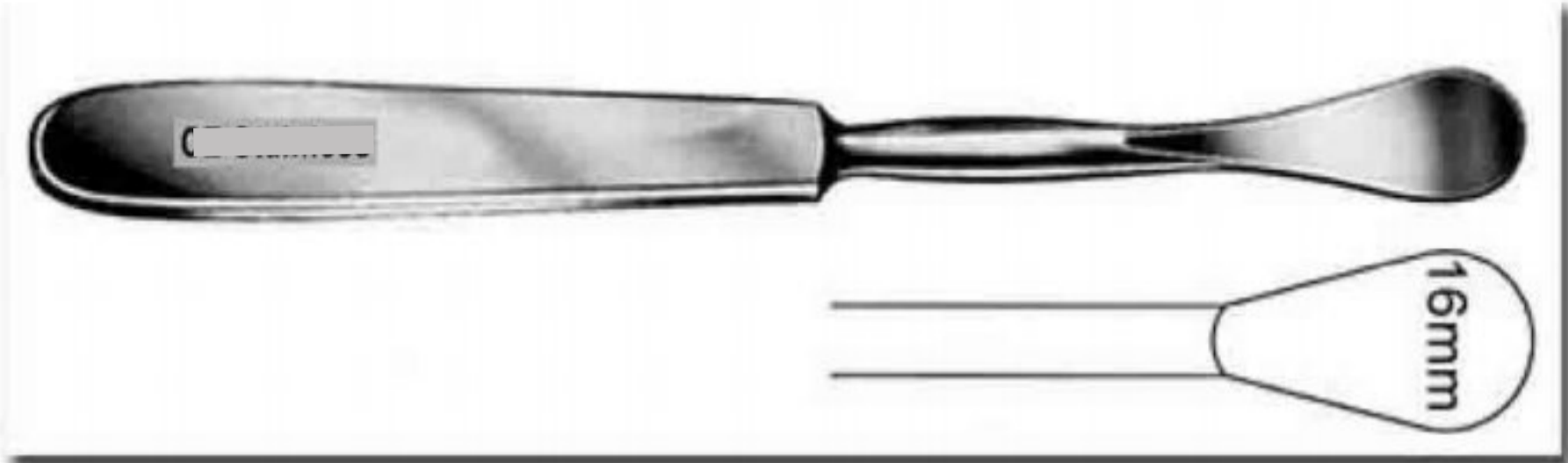

AJ-2427 Sedilot Elevator 18 cm / 7" Sharp Edge

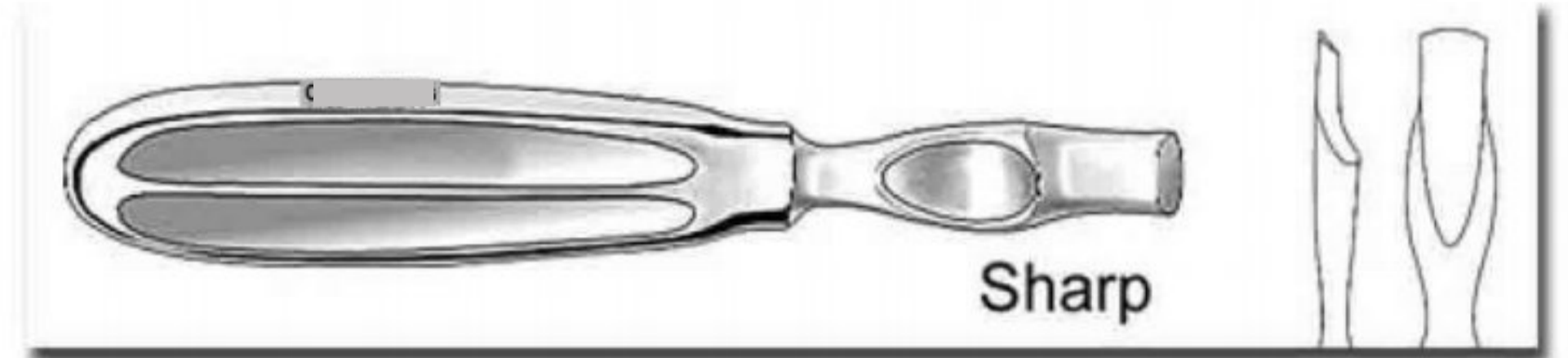

AJ-2428 Kirmission Periosteal Respiratory 17 cm / 6 3/4"



AJ-2429 Alexander Periosteal Respiratory
20 cm / 8" / 12mm Sharp

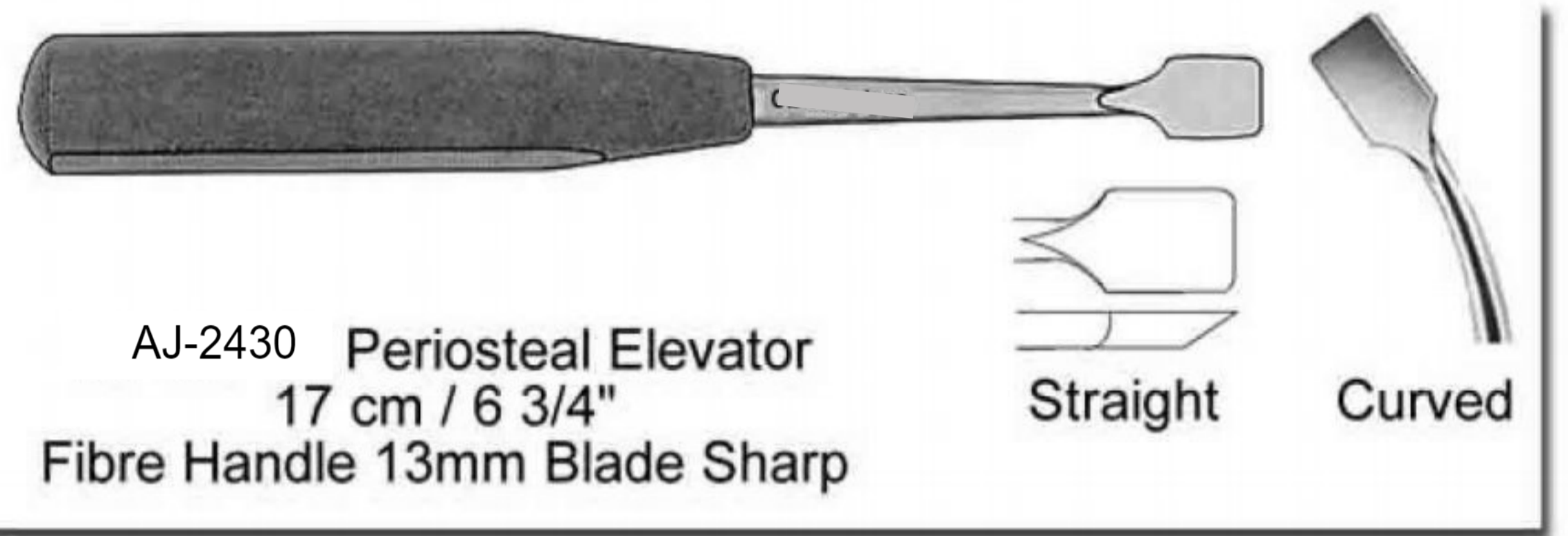

AJ-2430 Periosteal Elevator
17 cm / 6 3/4"
Fibre Handle 13mm Blade Sharp

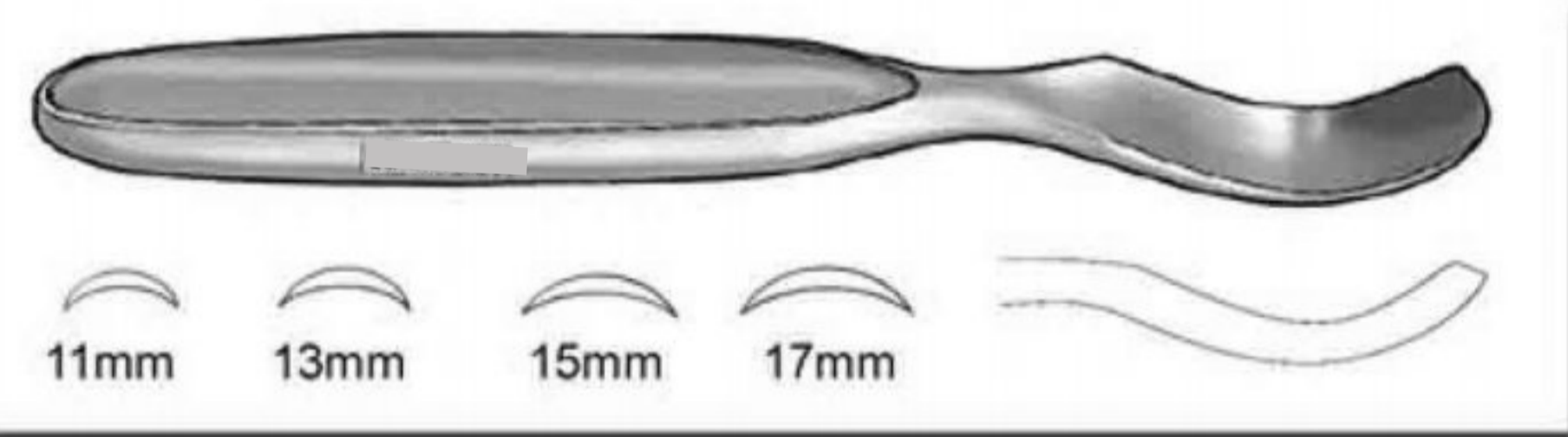

AJ-2431 McGlamry Metatarsal Elevator
16 cm / 6 1/2" Sharp



AJ-2432 Crego Periosteal Elevator
19 cm / 7 3/4" Sharp
A: 14mm Full Curves B: 14mm Slight Curves
C: 7mm Full Curves D: 7mm Slight Curves



AJ-2433 Chandler Elevator Blunt

A: 19cm / 7 1/2" 13mm B: 20cm / 8" 19mm
C: 23cm / 9" 25mm D: 25.5cm / 10" 30mm

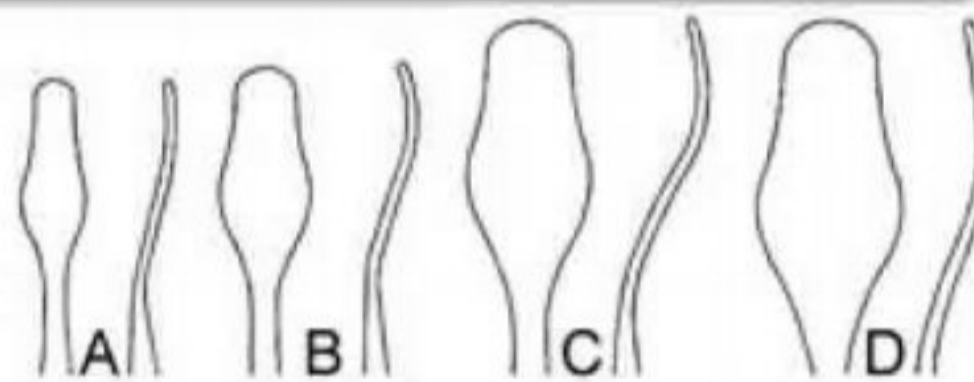

AJ-2434 Darrach Elevator Blunt

Small
A: 26cm / 10 1/4" 13mm Width at Tip
Medium
B: 26cm / 10 1/4" 20mm Width at Tip
Large
C: 35cm / 13 3/4" 25mm Width at Tip

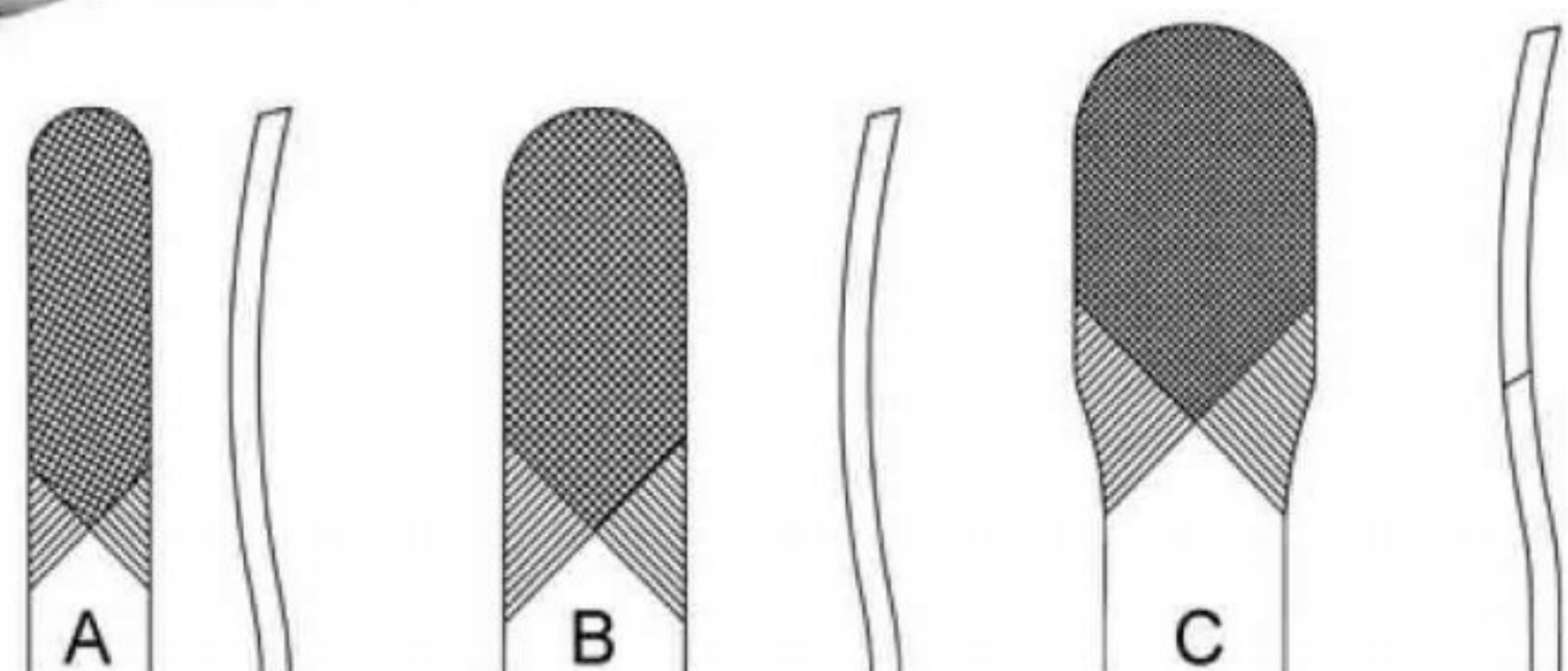
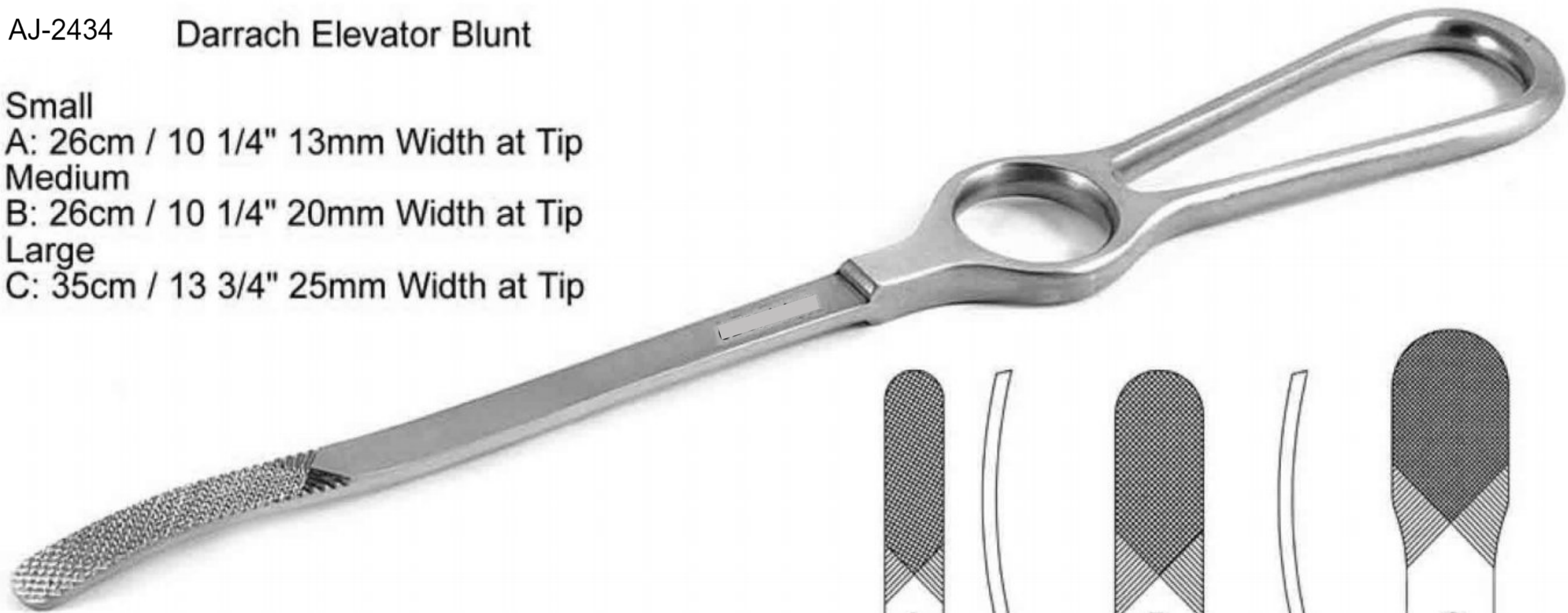

ELEVATORS

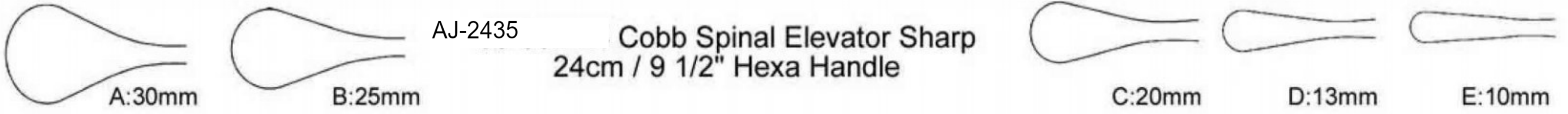

AJ-2435 Cobb Spinal Elevator Sharp
24cm / 9 1/2" Hexa Handle

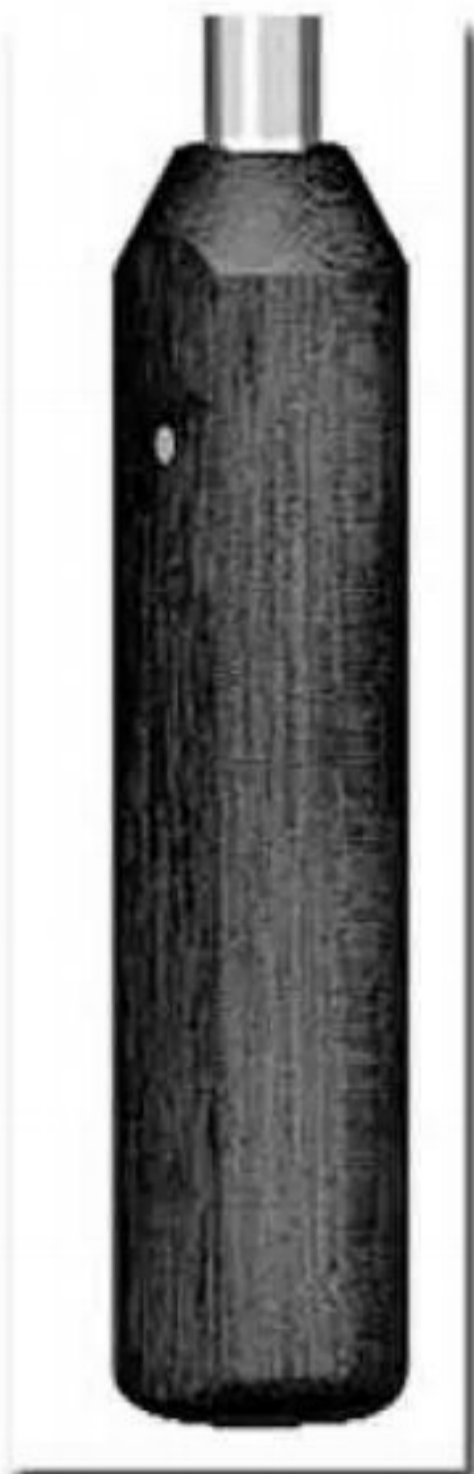

Also Available
in Fibre Handle

with Same
Sizes
of Blades

AJ-2436
25cm / 10"

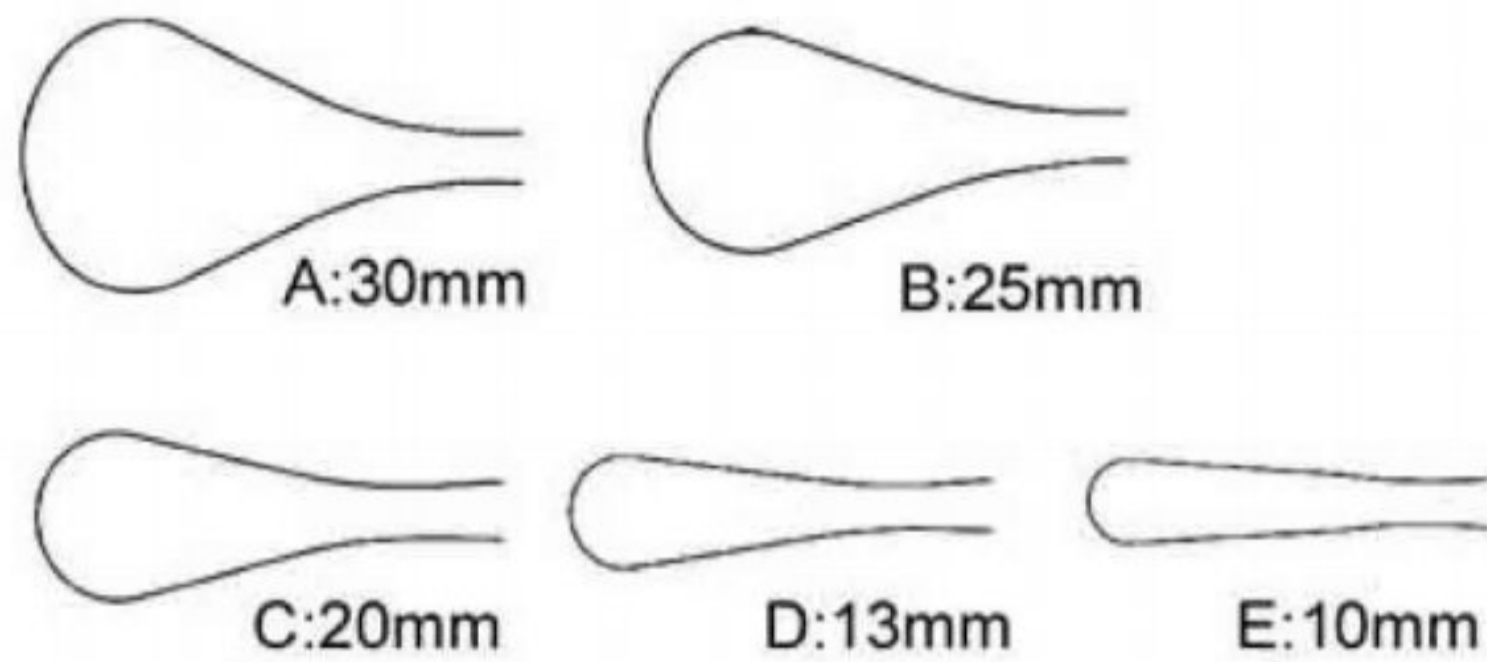

AJ-2437 Cobb Spinal Elevator Sharp
28cm / 11" Knurled Handle



AJ-2438 Cobb Elevator Endoscopic Sharp / Fibre Handle

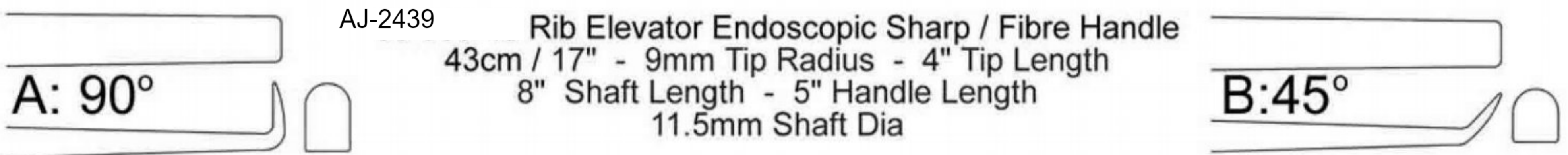

AJ-2439 Rib Elevator Endoscopic Sharp / Fibre Handle
43cm / 17" - 9mm Tip Radius - 4" Tip Length
8" Shaft Length - 5" Handle Length
11.5mm Shaft Dia

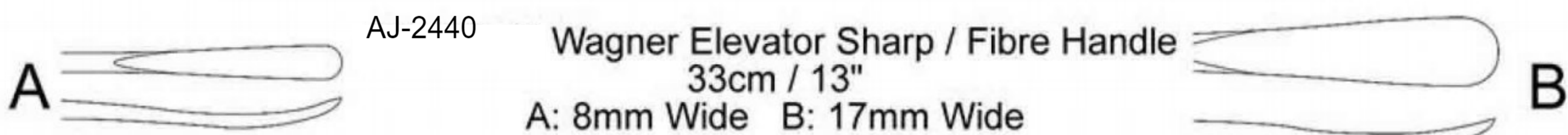

AJ-2440 Wagner Elevator Sharp / Fibre Handle
33cm / 13"
A: 8mm Wide B: 17mm Wide

BONE MALLETS

Note: Handle Shown In Dark Colors are Made of FIBRE Material

AJ-2441 Lucae Mallet 19.5cm / 7 3/4"

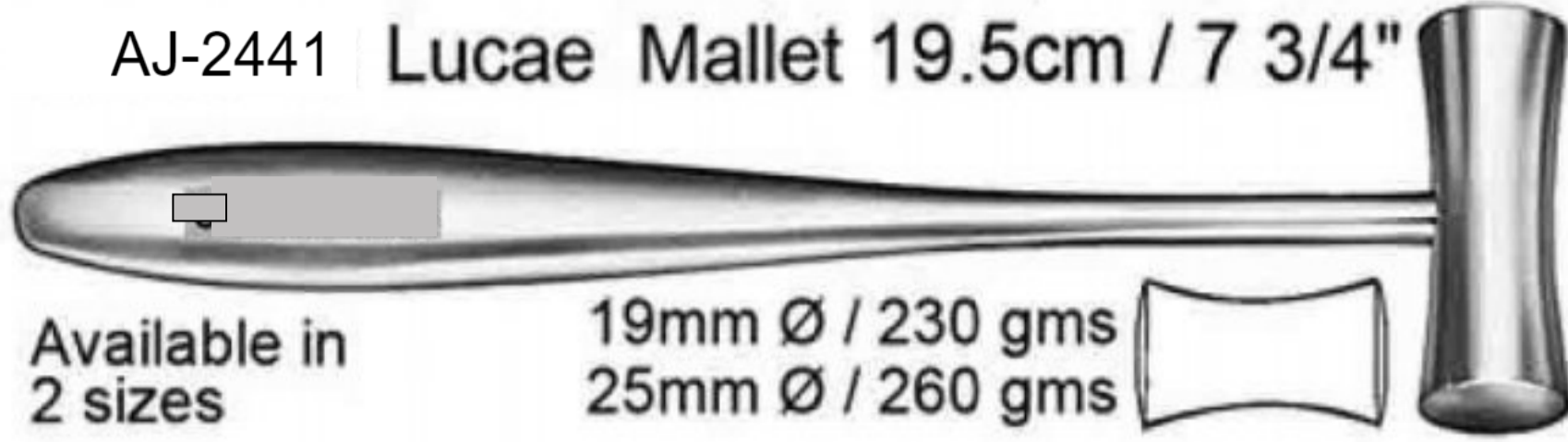

Available in 2 sizes
19mm Ø / 230 gms
25mm Ø / 260 gms

AJ-2442 Cottle Mallet Plane / Convex

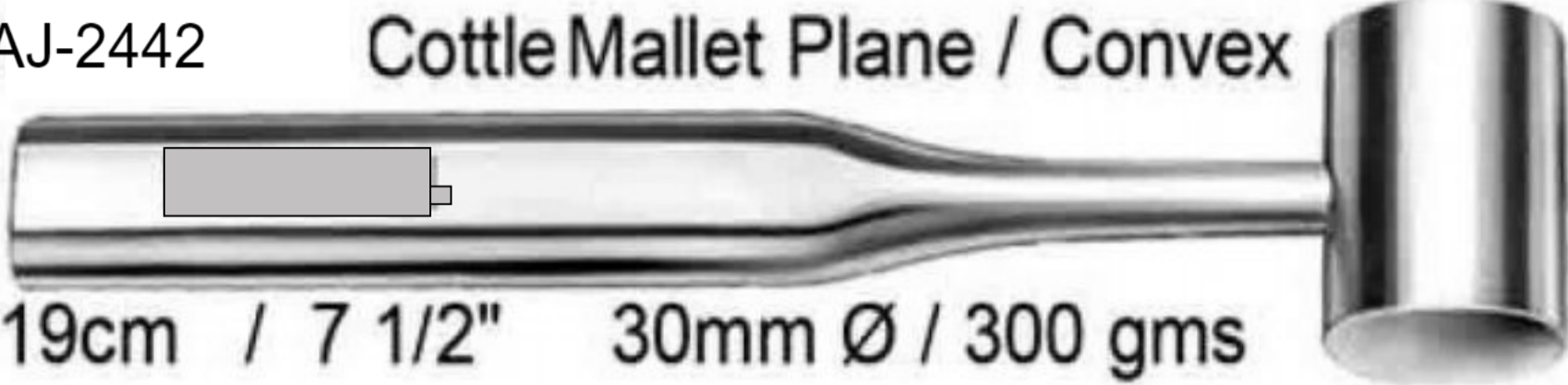

19cm / 7 1/2" 30mm Ø / 300 gms

AJ-2443 Williger Mallet 20mm Ø / 140 gms

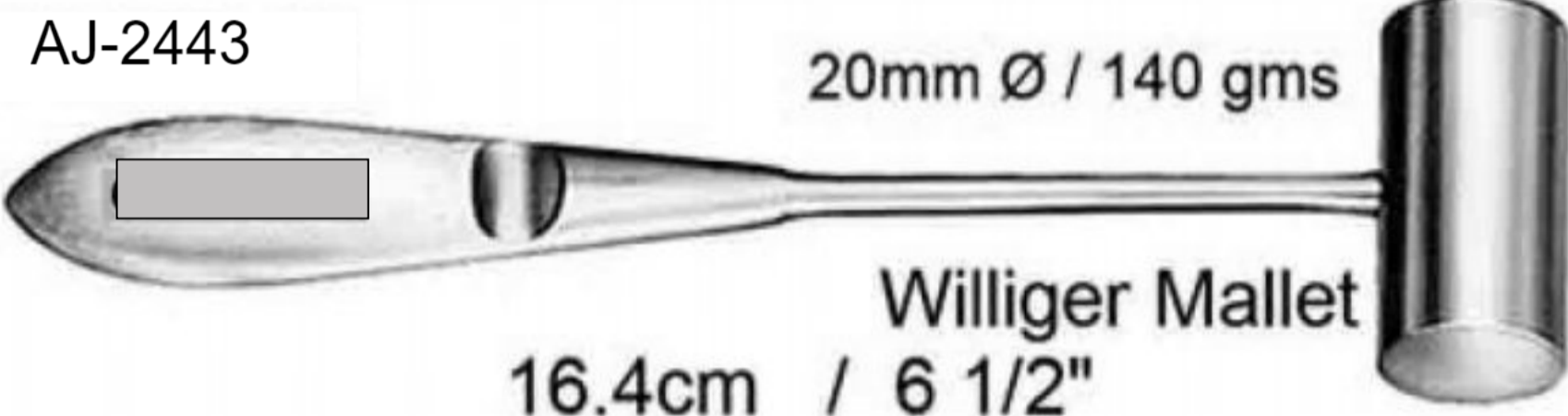

16.4cm / 6 1/2"

AJ-2444 Mallet 26 cm / 10 1/4"



30mm Ø / 510 gms

AJ-2445 Mead Mallet 19 cm / 7 1/2"

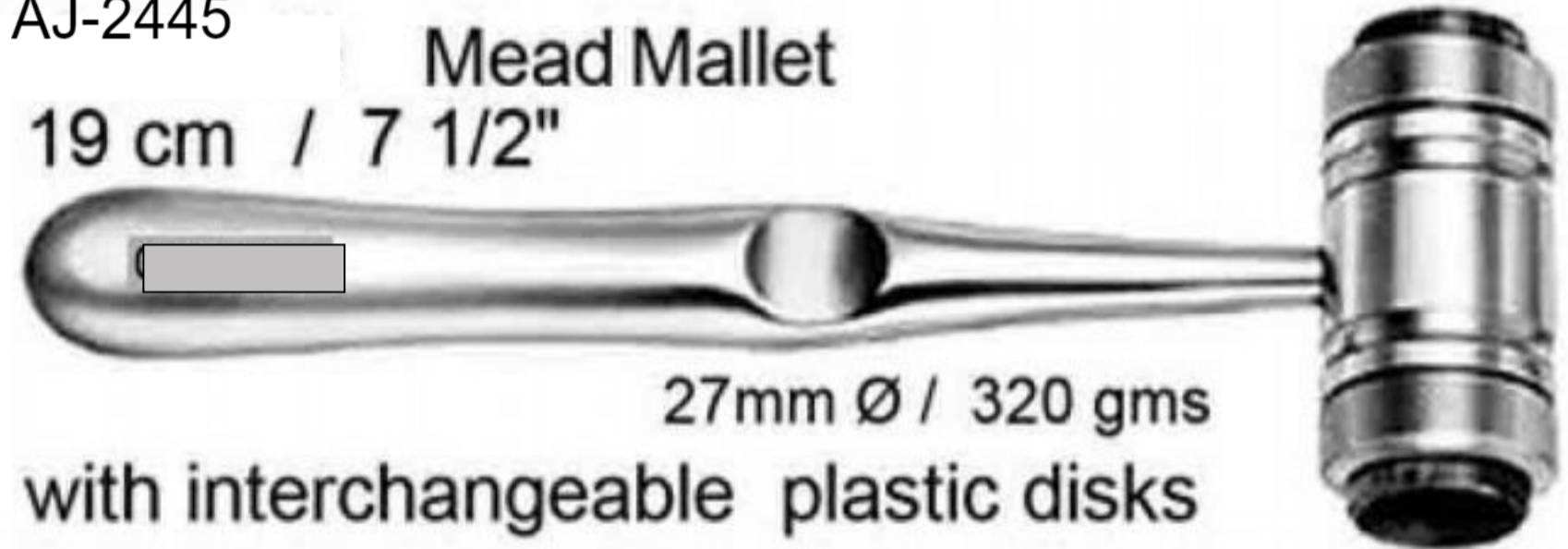

27mm Ø / 320 gms
with interchangeable plastic disks

AJ-2446 Partsch Mallet 22mm Ø / 200 gms

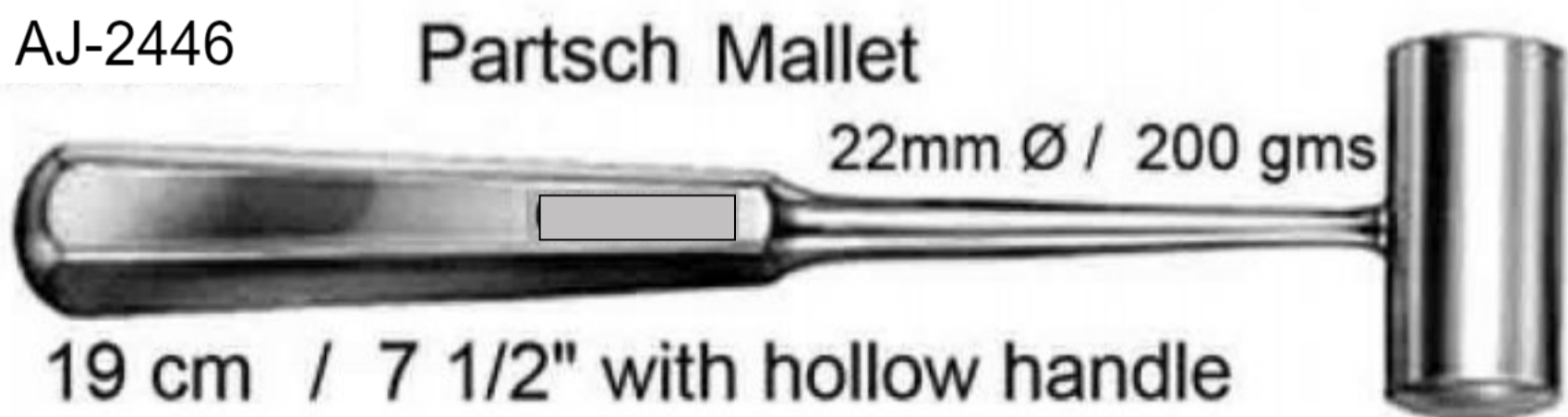

19 cm / 7 1/2" with hollow handle

AJ-2447 Mallet 26 cm / 10 1/4" with lead filling



Also available without lead filling
42mm Ø / 400 gms

AJ-2448 Mallet 26 cm / 10 1/4"

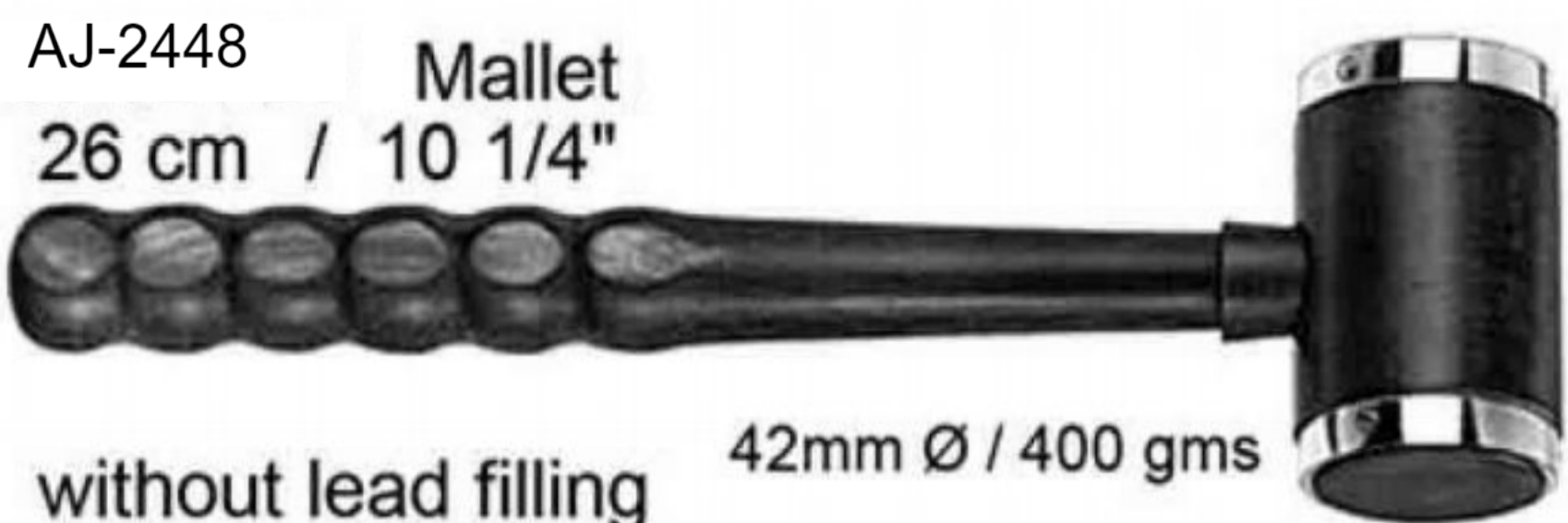

without lead filling 42mm Ø / 400 gms

AJ-2449 Williger Mallet

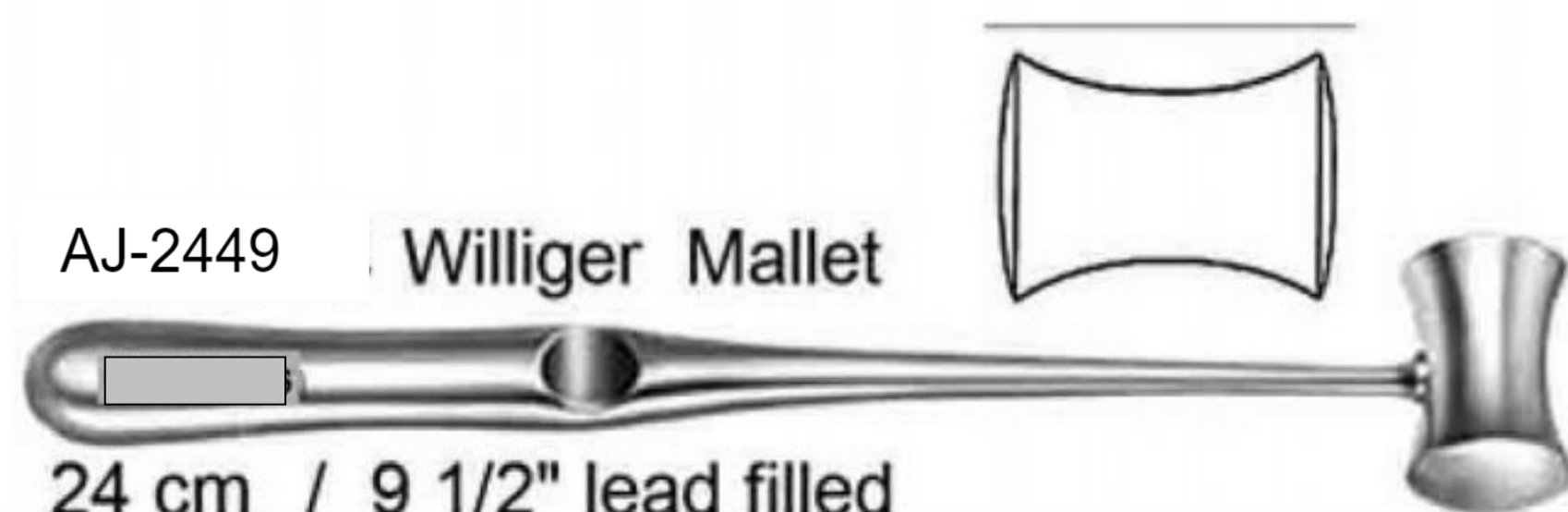

24 cm / 9 1/2" lead filled

Available Head Sizes & Approximate Weight
26mm Ø / 300 gms 28mm Ø / 340 gms
30mm Ø / 400 gms

AJ-2450 Mallet 30mm Ø / 675 gms
26.5 cm / 10 1/2"



plane (Teflon) / convex (steel)

AJ-2451 Mallet 26 cm / 10 1/4"



42 / 30mm Ø / 530 gms

AJ-2452 Mallet 24 cm / 9 1/2"

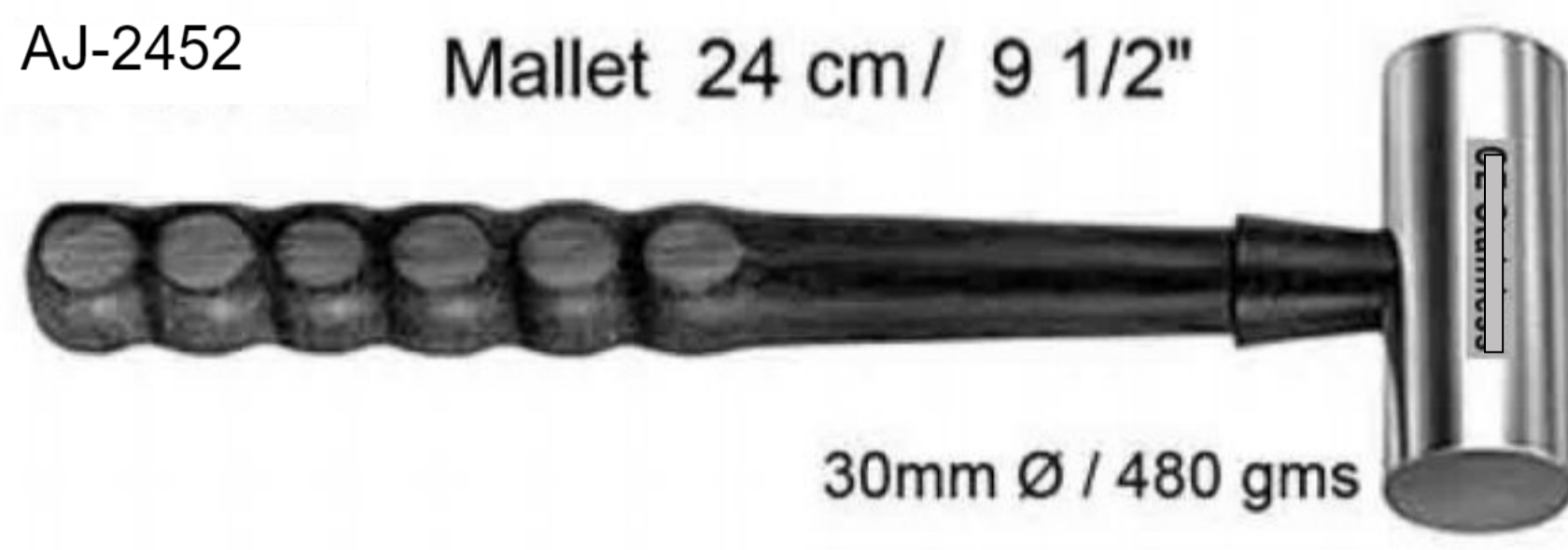

30mm Ø / 480 gms

AJ-2453 Mallet 24 cm / 9 1/2" Disks and handle of

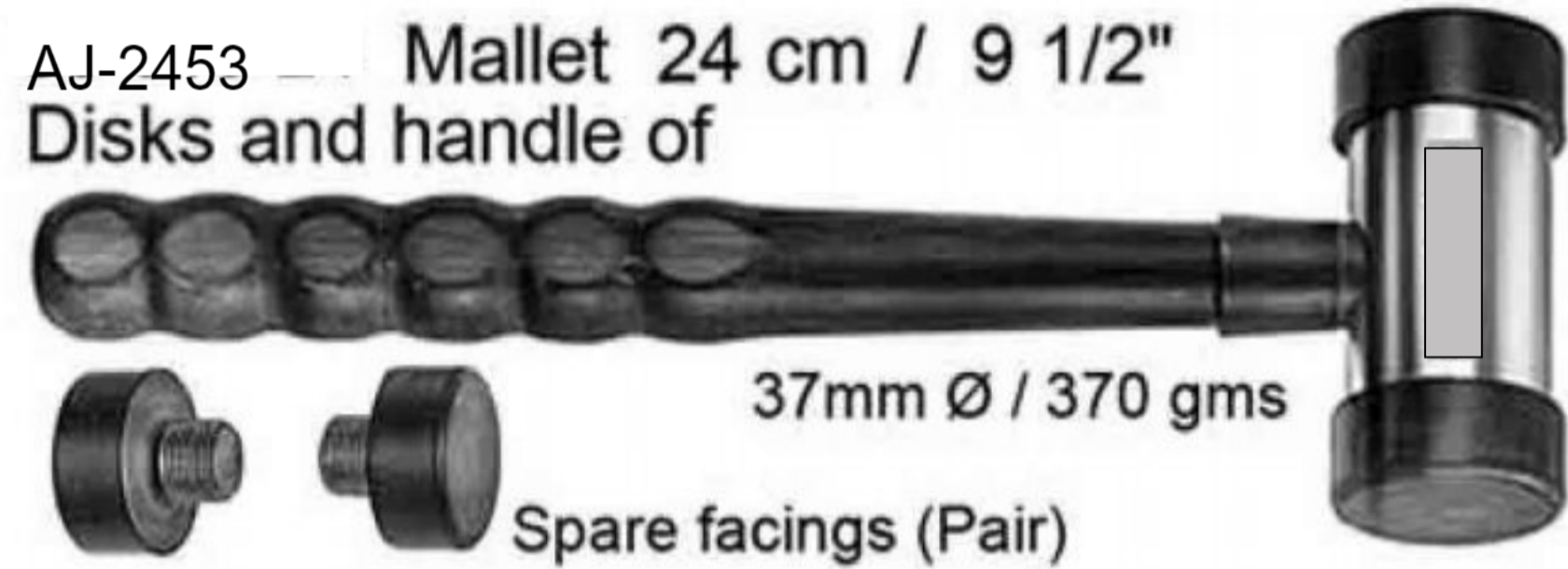

37mm Ø / 370 gms

Spare facings (Pair)

AJ-2454 30mm Ø / 125 gms



Mallet 22 cm / 8 3/4"

AJ-2455 Mallet 26.5 cm / 10 1/2"



30mm Ø / 450 gms

AJ-2456 A/B/C Doyen Mallet



Available Length / Head Sizes & Approximate Weight

A: 20.5cm / 8" 25mm Ø / 120 gms
B: 21cm / 8 1/4" 30mm Ø / 180 gms
C: 21.5cm / 8 1/2" 35mm Ø / 260 gms

AJ-2457 Herbert Mallet 19 cm / 7 1/2"



for ulnar head prosthesis



Head size / approximate weight
23mm Ø / 220 gms

30-525-20
Collin Mallet
20cm / 8"



30-526-26 Mallet
26.5 cm / 10 1/2"

50mm Ø / 900 gms



30-527-19 Vickers Mallet
19 cm / 7 1/2"

25mm Ø / 300 gms

Teflon disks

BONE MALLETS

Note: Handle Shown In Dark Colors are Made of FIBRE Material



AJ-2461
Kirk Mallet 20cm / 8"
Head Dia 38mm/Weight: 1 lb. 4 oz. (570 grams)



Head Weight: 7 oz (200 grams)

AJ-2462 Gerzog Mallet 19cm / 7 1/2"
Head Dia 25mm/Weight 10 oz (285 grams)

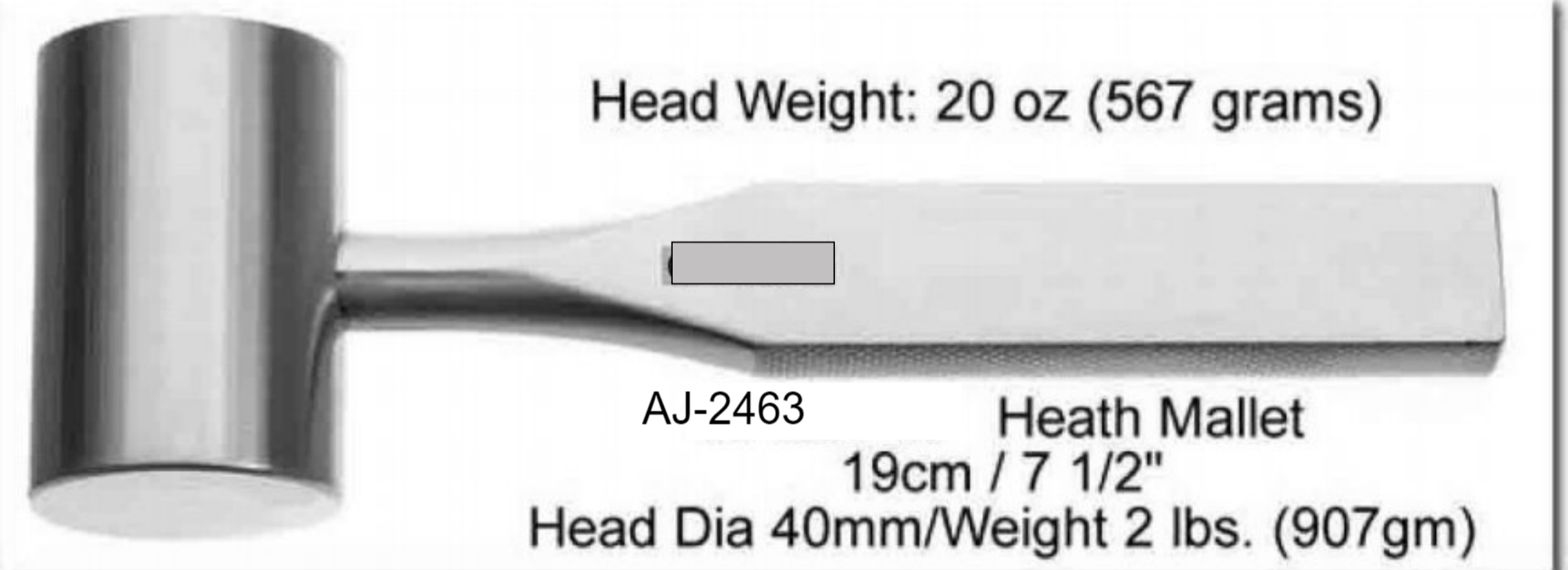

Head Weight: 20 oz (567 grams)

AJ-2463 Heath Mallet
19cm / 7 1/2"
Head Dia 40mm/Weight 2 lbs. (907gm)

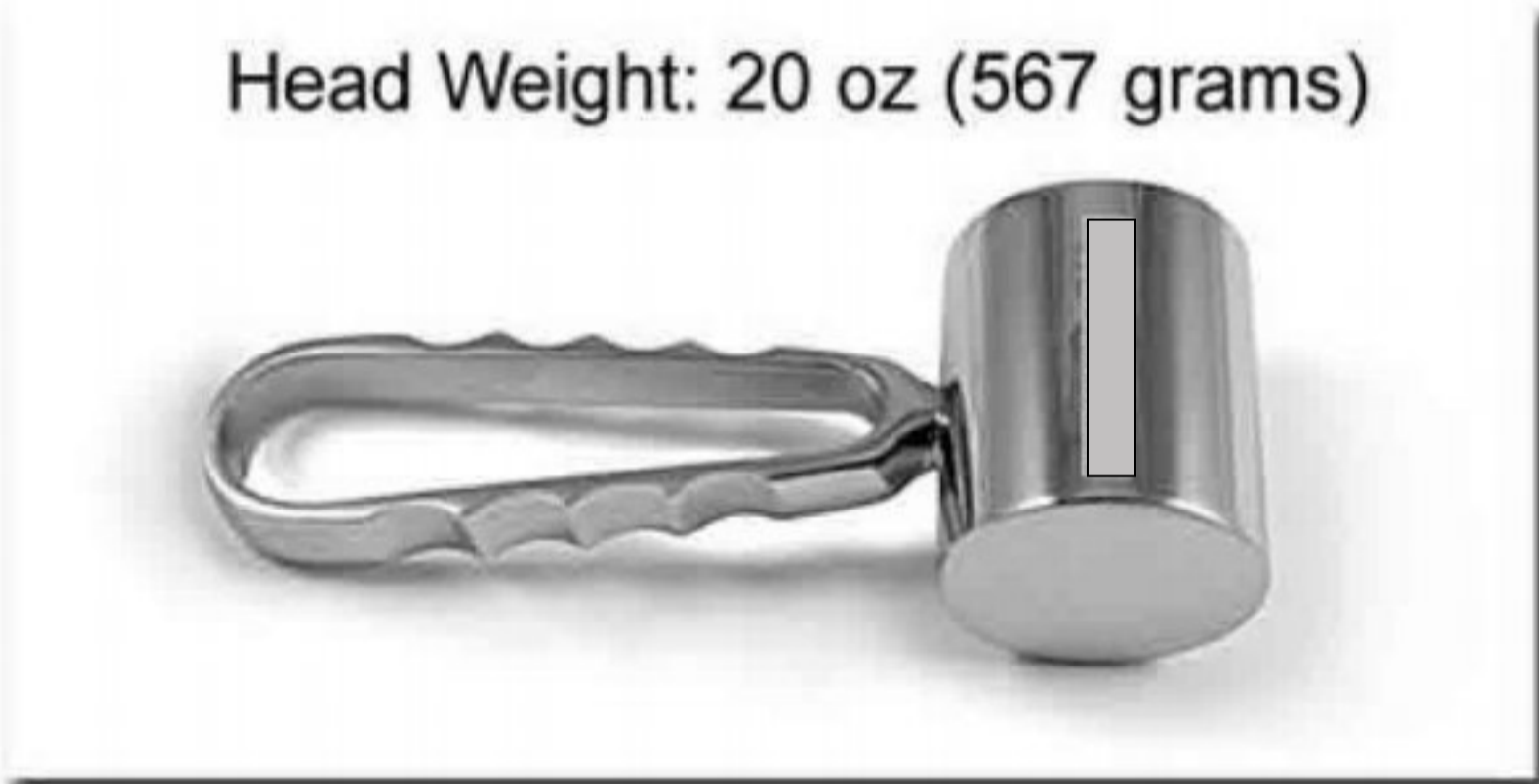

Head Weight: 20 oz (567 grams)

AJ-2466 Heath Mallet, SS
18cm / 7" Solid Frame Handle
Head Dia 40mm/Weight 36 oz. (1020gm)



AJ-2468 All Fibre Mallet 24cm / 9 1/2"
Head Dia 80X60mm Weight 14oz. (397gm)



Fibre Handle

AJ-2464
Cloward Mallet
19cm / 7 1/2"
Head Dia 20mm
Weight 8oz. (227gm)



AJ-2465
Hajek Mallet
20cm / 8"
Head Dia 27mm
Weight 7oz. (198gm)

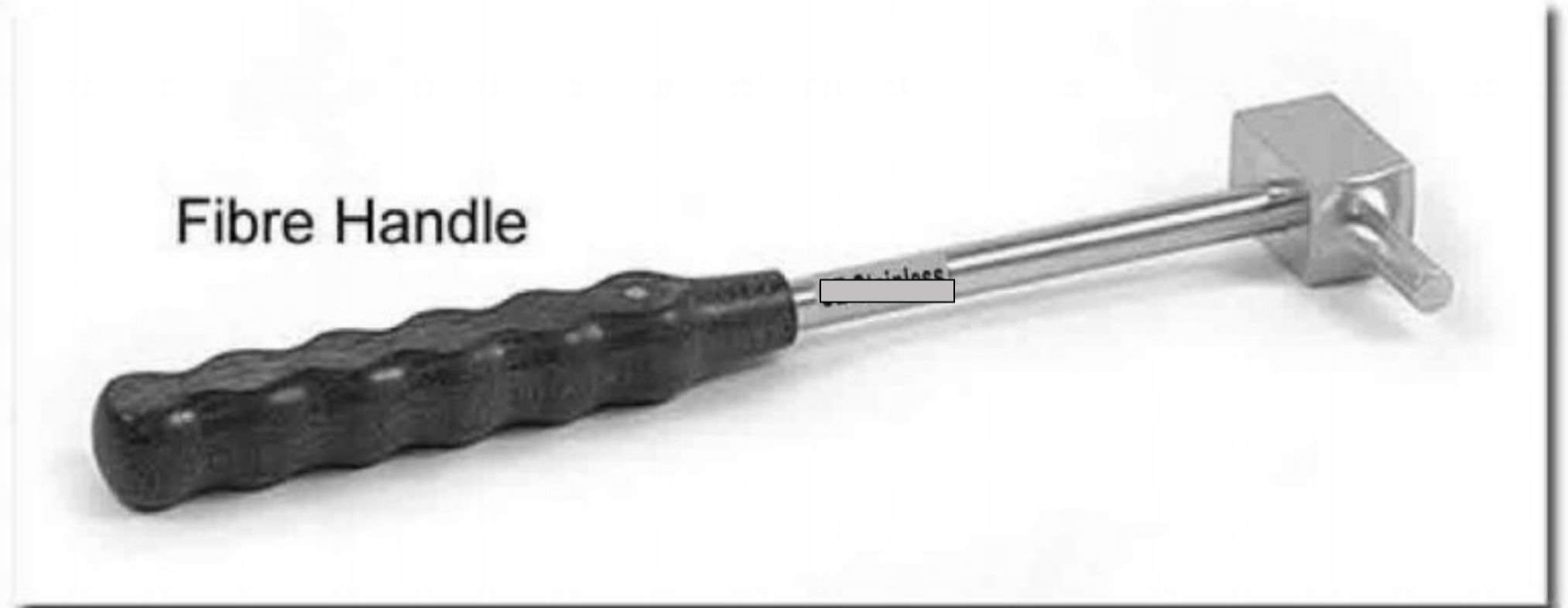

Fibre Handle

AJ-2467 Narrow Tip Mallet 20cm / 8"
Head Dia 7mm Weight 6oz. (170gm)



30-535-23 Fibre Handle Mallet 23cm / 9"
Head Dia 30mm/Weight 12 oz. (340gm)
Also Available in:
Head Dia 35mm/Weight 1lb 40 oz. (570gm)
Head Dia 40mm/Weight 1lb 90 oz. (708gm)



AJ-2469 He-Man Mallet 28cm / 11"
Head Dia 38mm / 24mm
Weight 2lb (906gm)

TENDON - CARTILAGE - MENISCUS TOOLS

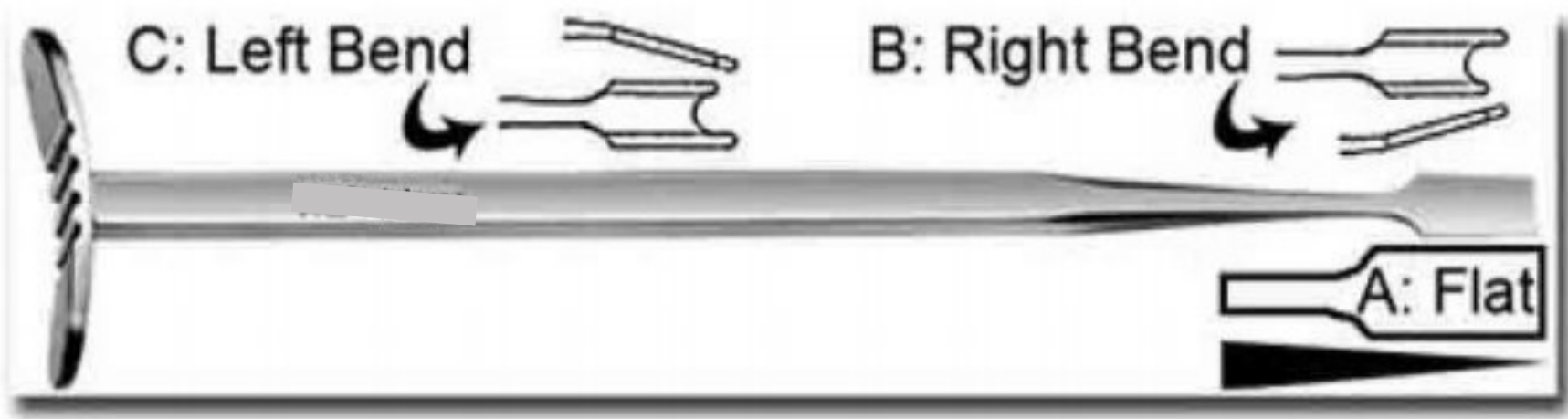

AJ-2470 Smillie Meniscus Knife 18 cm / 7"



AJ-2471 Meniscus Knife 18 cm / 7"

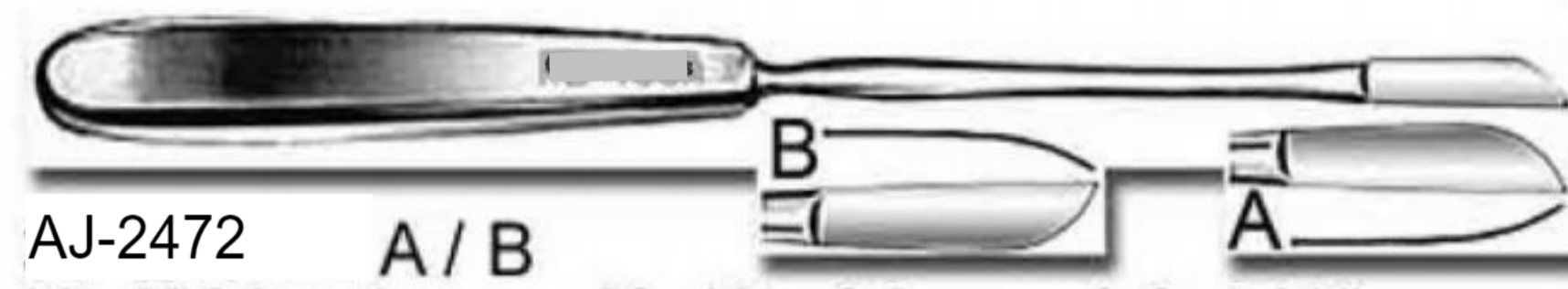

AJ-2472 A/B Neff Meniscus Knife 22 cm / 8 3/4"



AJ-2473 A/B Salenius Meniscus Knife 21 cm / 8 1/4" A: Right / B: Left



AJ-2474 Bunnell Tendon Stripper 15 cm / 6" 3mm 4mm 5mm 6mm 7mm

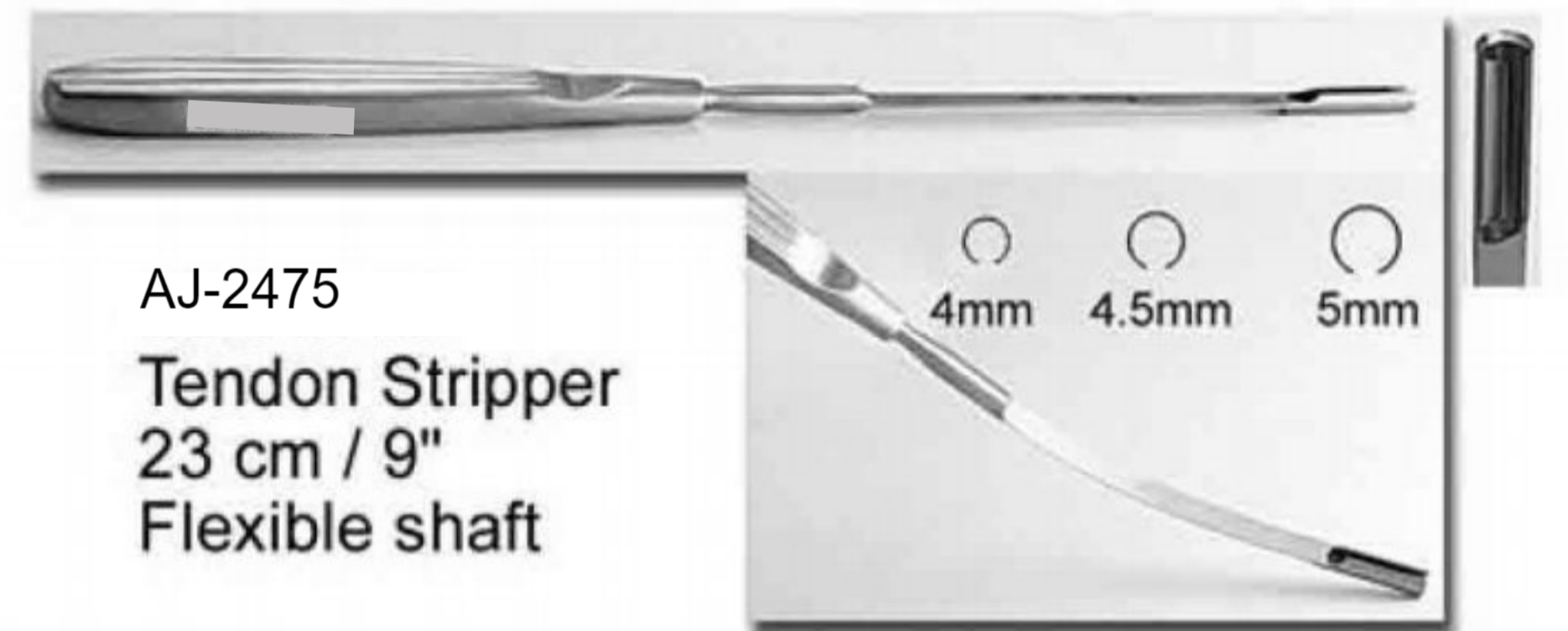

AJ-2475 Tendon Stripper 23 cm / 9" Flexible shaft

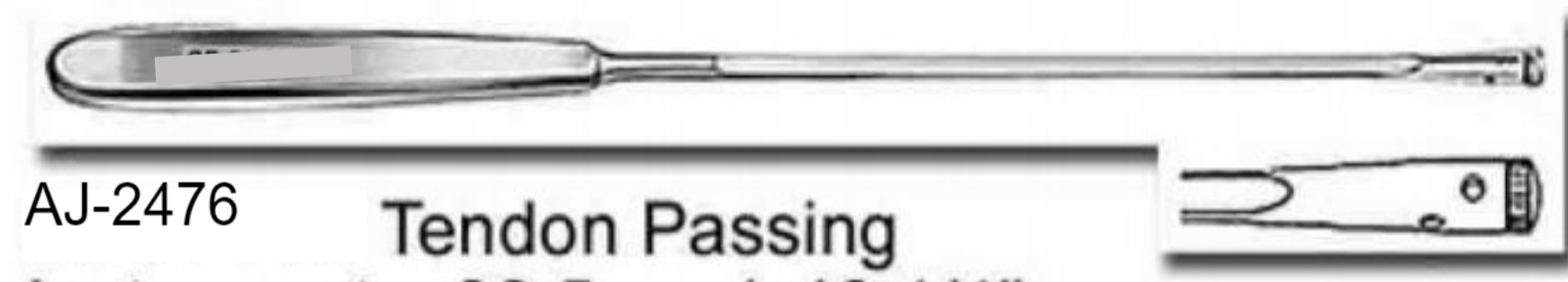

AJ-2476 Tendon Passing Instrument 33.5 cm / 13 1/4"

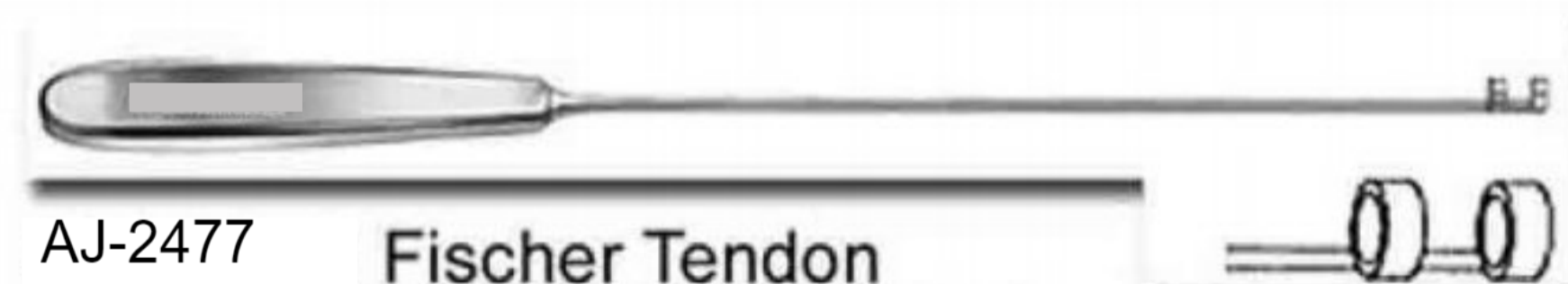

AJ-2477 Fischer Tendon Stripper 31 cm / 12 1/4" Blunt



AJ-2478 Tendon Stripper 3 / 4 / 5 / 6mm A: 28.5 cm / 11 1/4" B: 60 cm / 24"

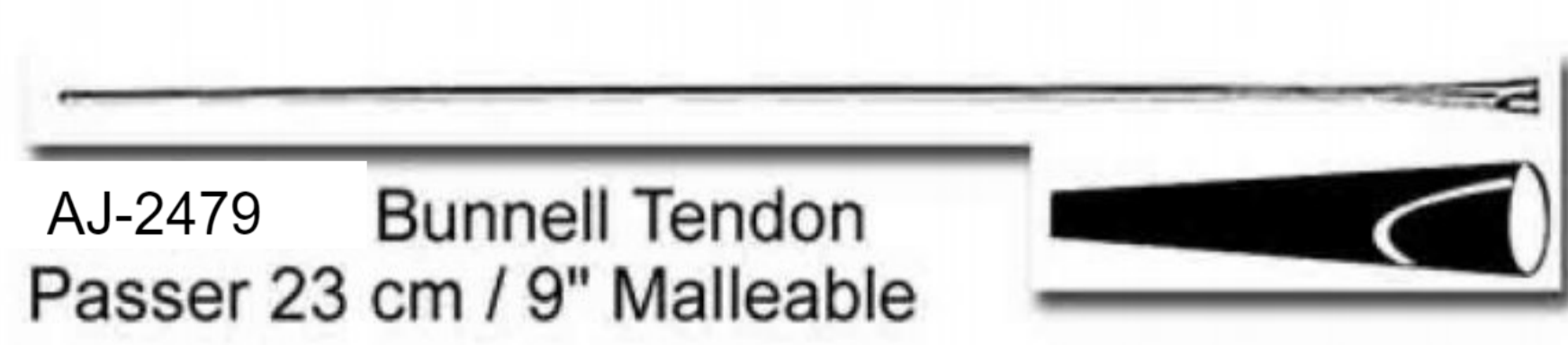

AJ-2479 Bunnell Tendon Passer 23 cm / 9" Malleable



AJ-2480 Tendon Stripper 40 cm / 16" Fibre Handle

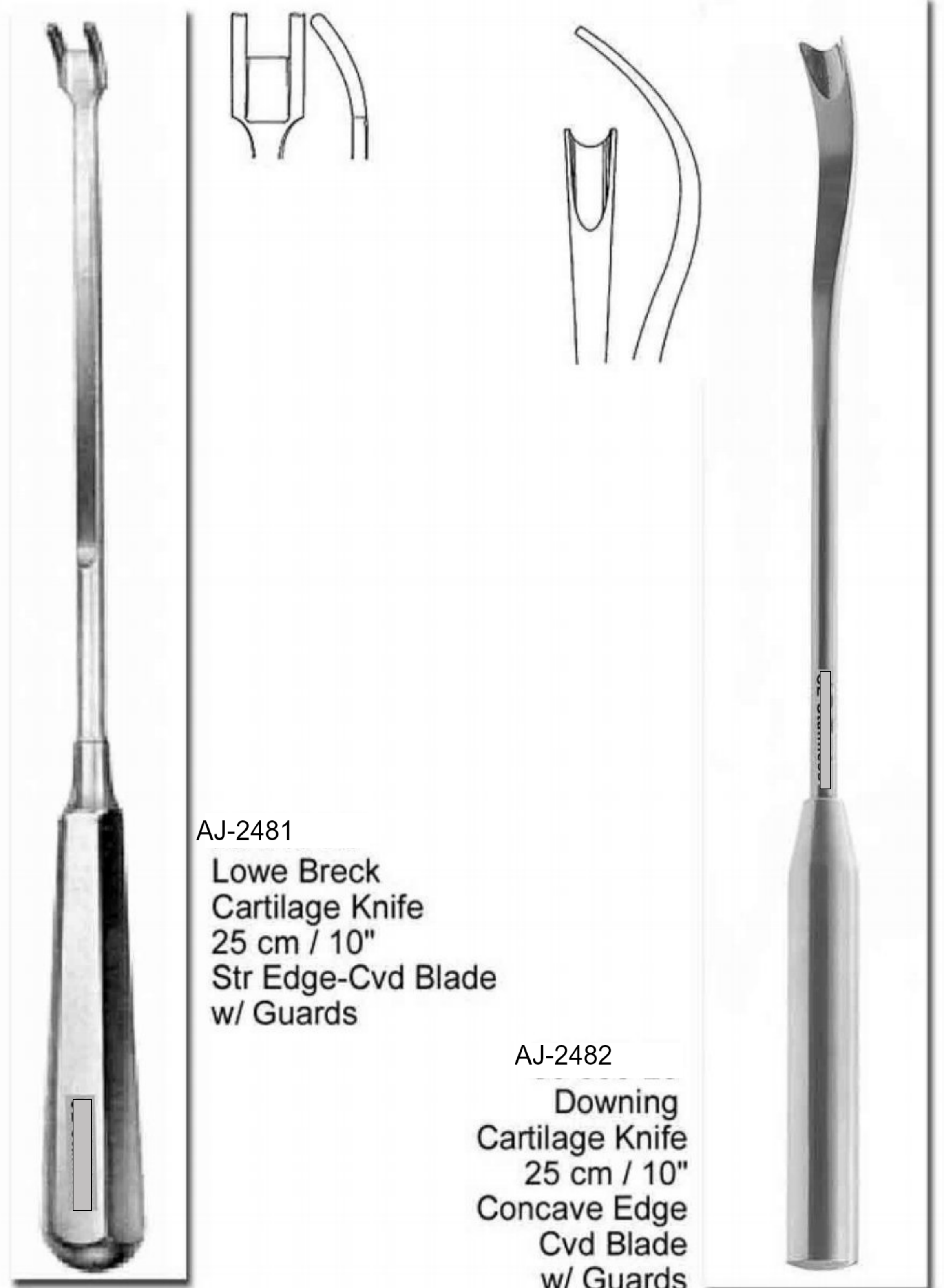

AJ-2481 Lowe Breck Cartilage Knife 25 cm / 10" Str Edge-Cvd Blade w/ Guards

AJ-2482 Downing Cartilage Knife 25 cm / 10" Concave Edge Cvd Blade w/ Guards

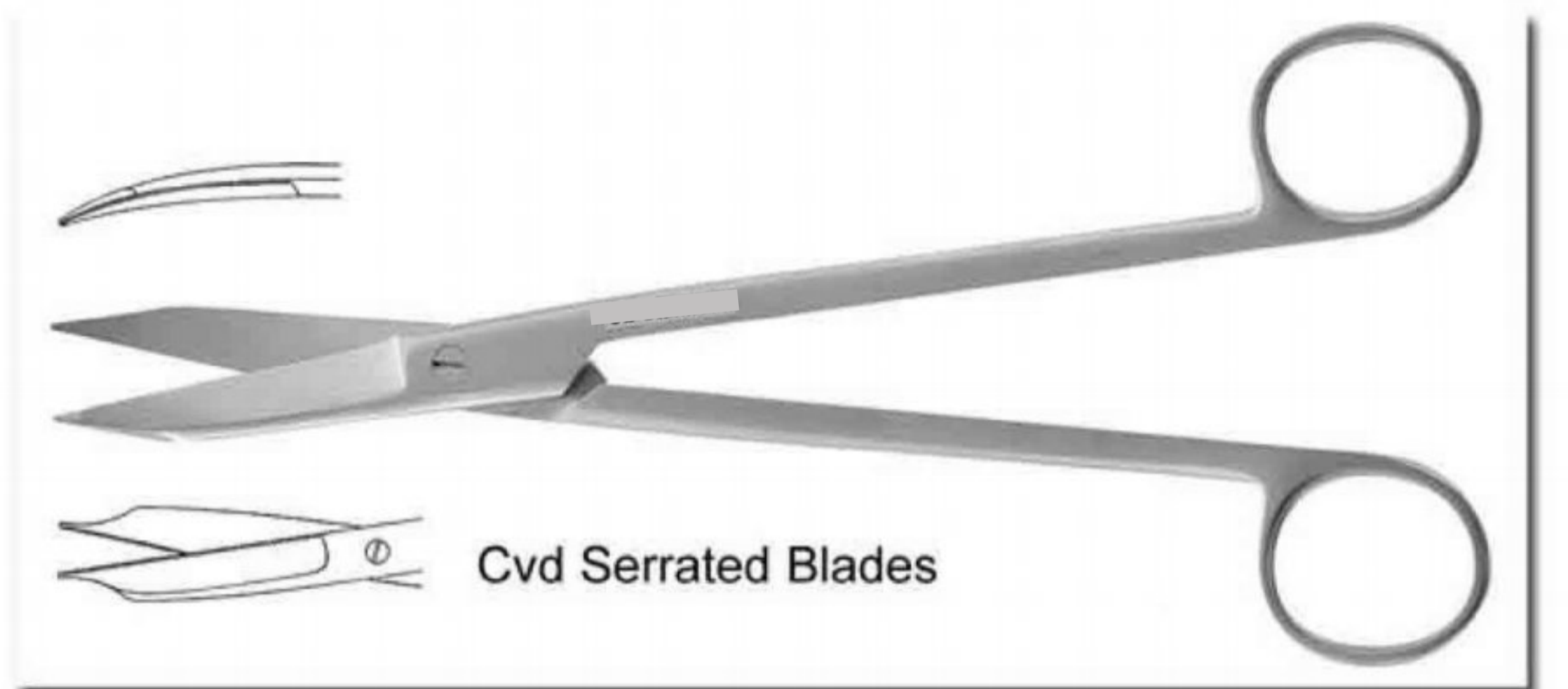

AJ-2483 Martin Cartilage Scissors 20cm / 8" Cvd Serrated Blades

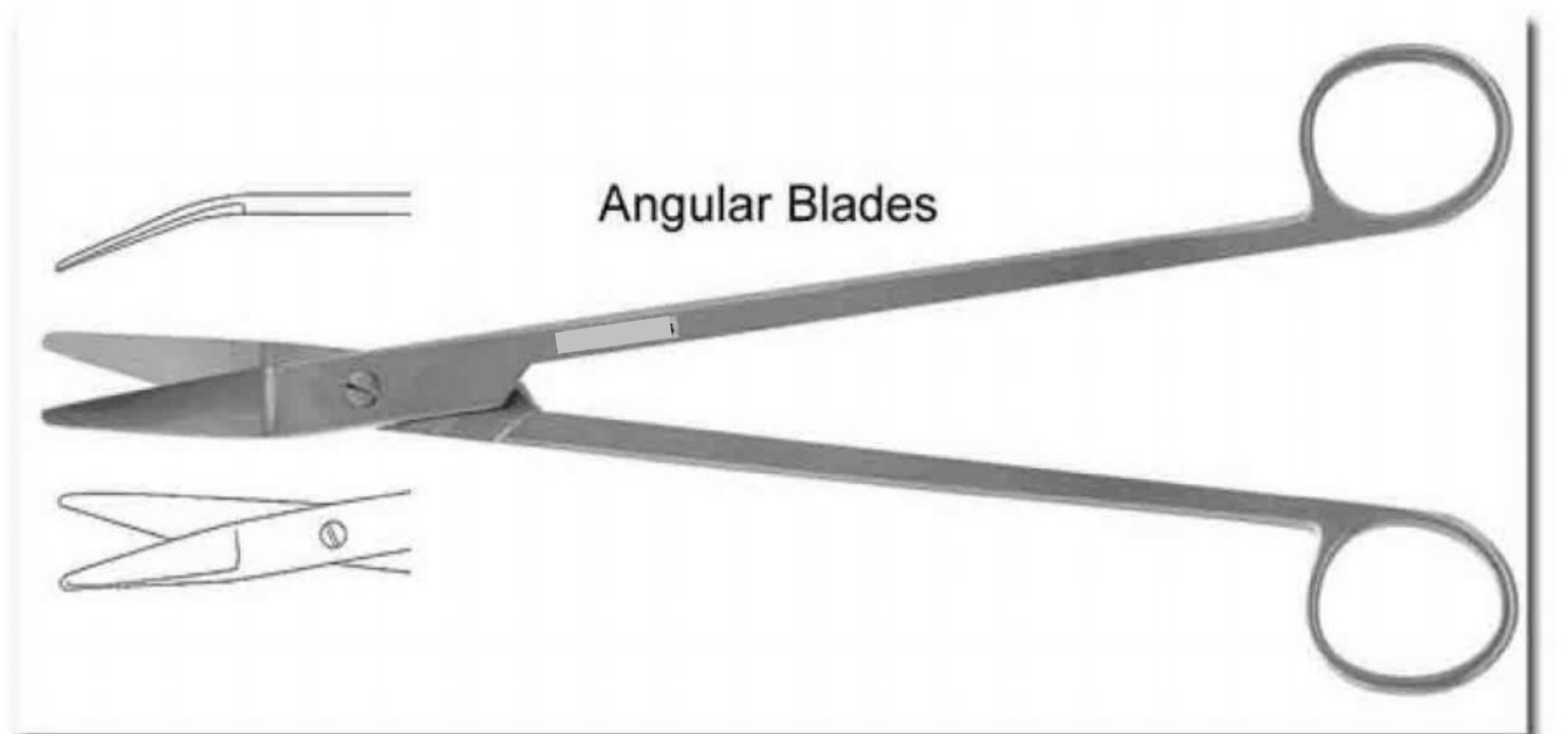

AJ-2484 Mueller Capsule Scissors 24cm / 9 1/2" Angular Blades

TENDON INSTRUMENTS

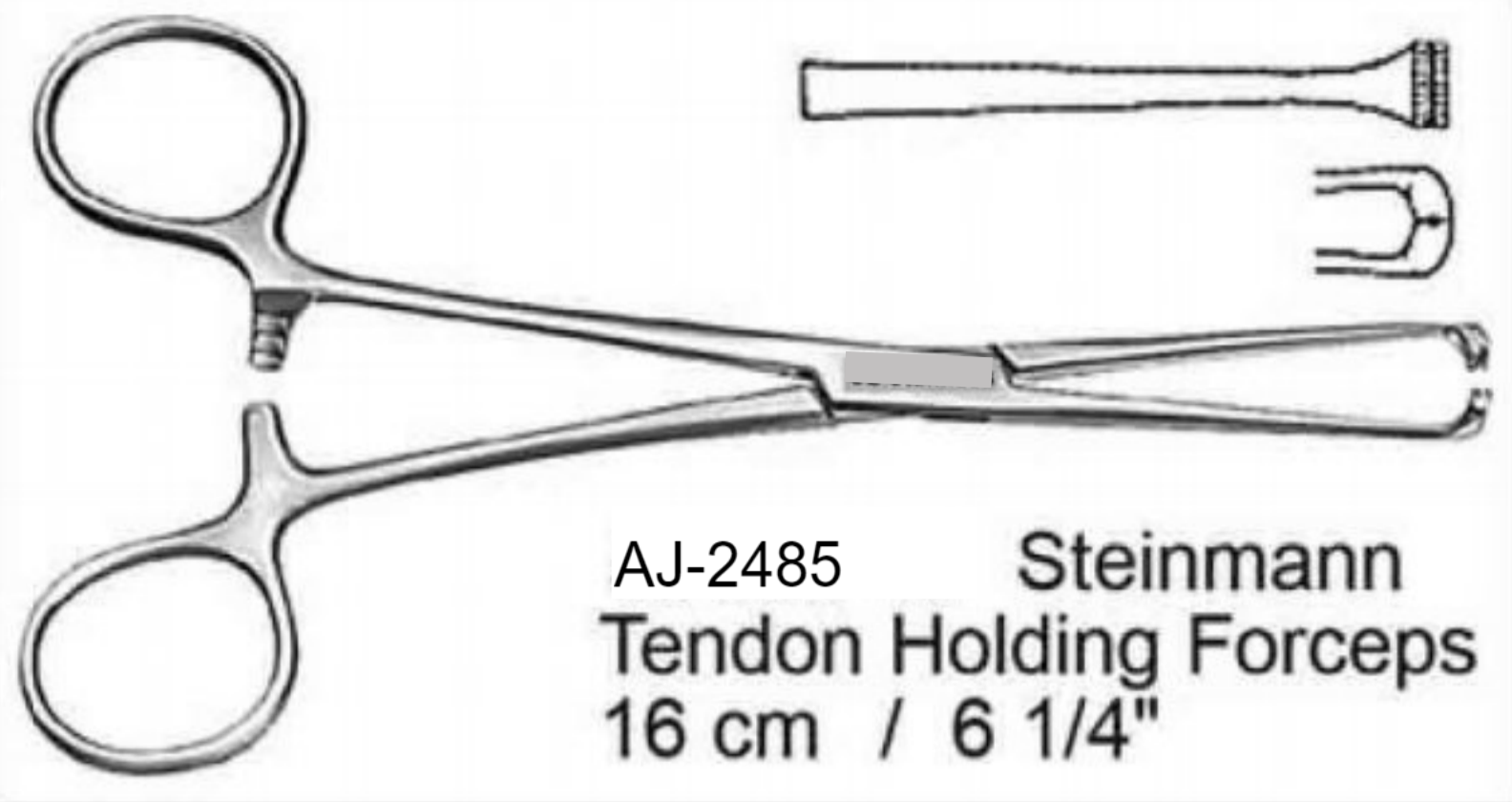

AJ-2485 Steinmann
Tendon Holding Forceps
16 cm / 6 1/4"

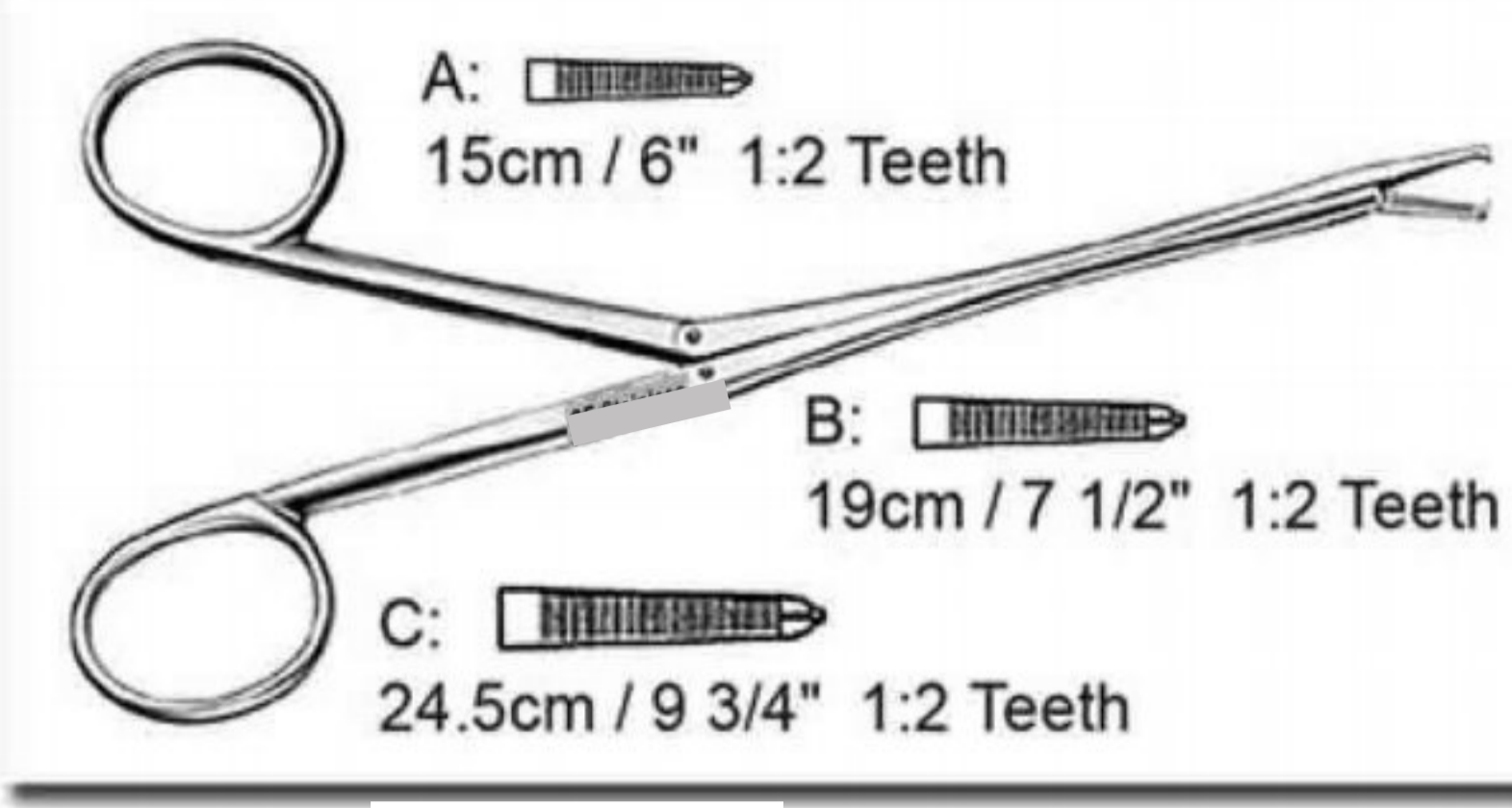

AJ-2486 A / B / C
Brand Tendon Tunnelling Forceps

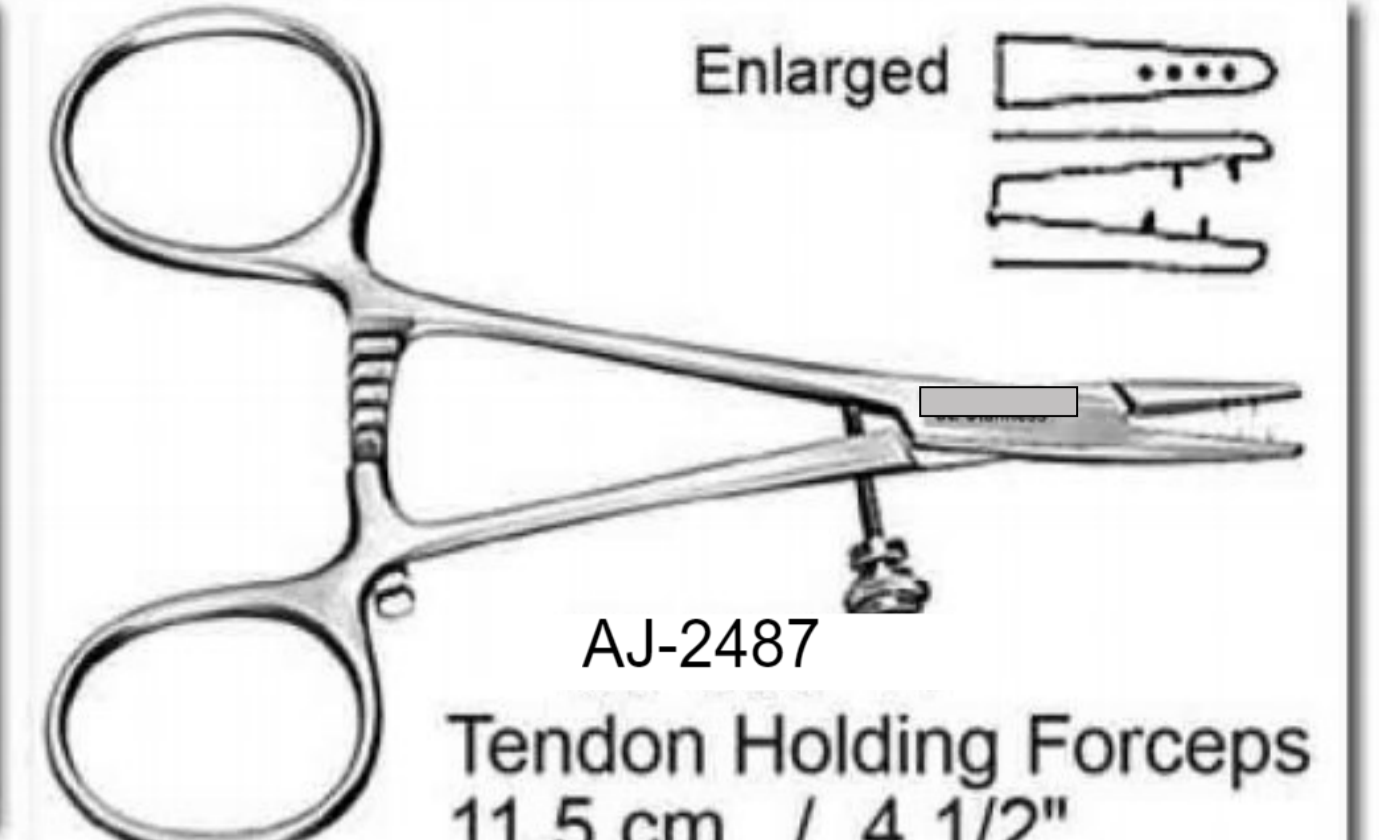

AJ-2487
Tendon Holding Forceps
11.5 cm / 4 1/2"

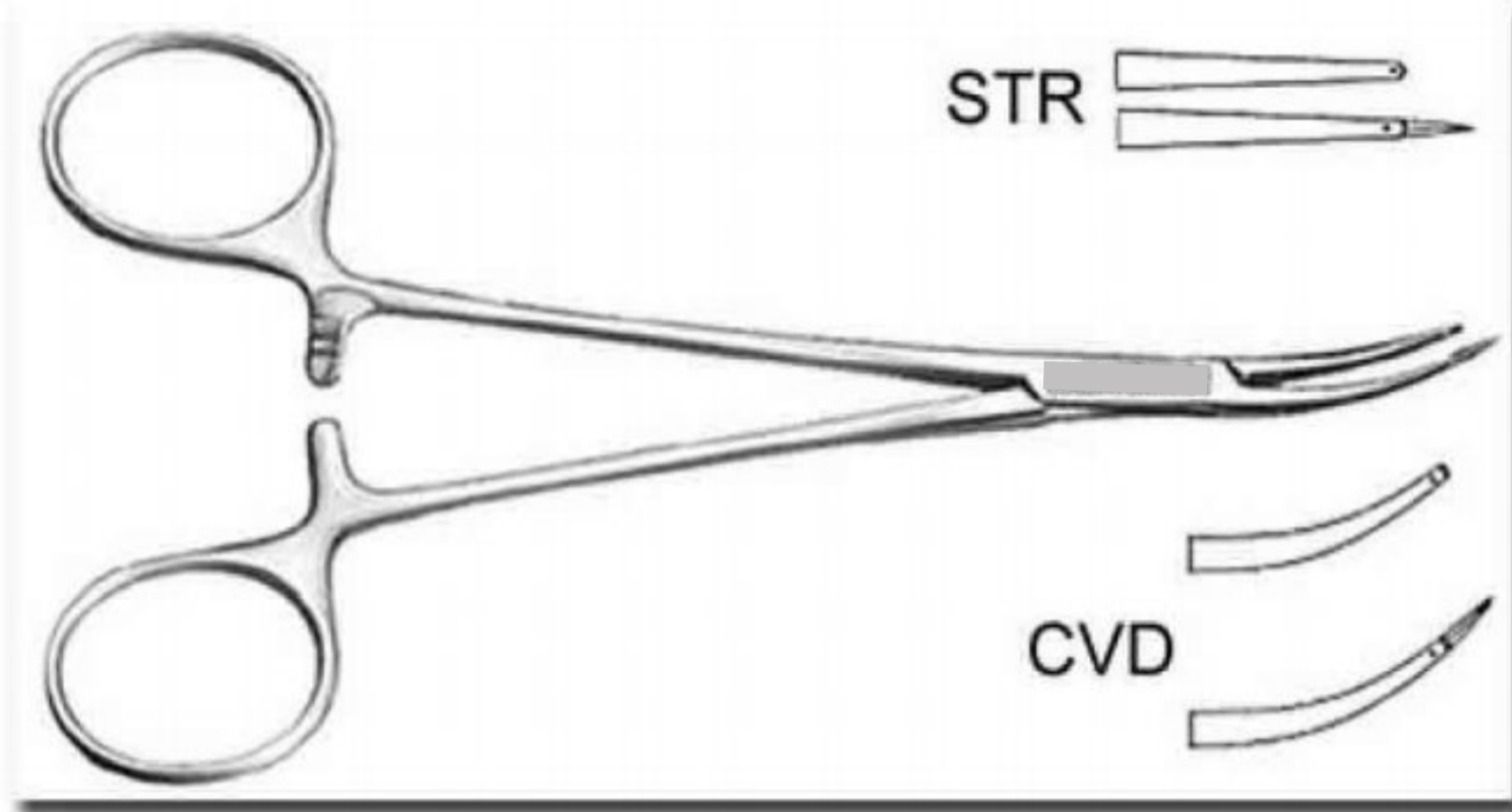

AJ-2488 Tendon Interlacing Forceps
15.5 cm / 6" Pointed

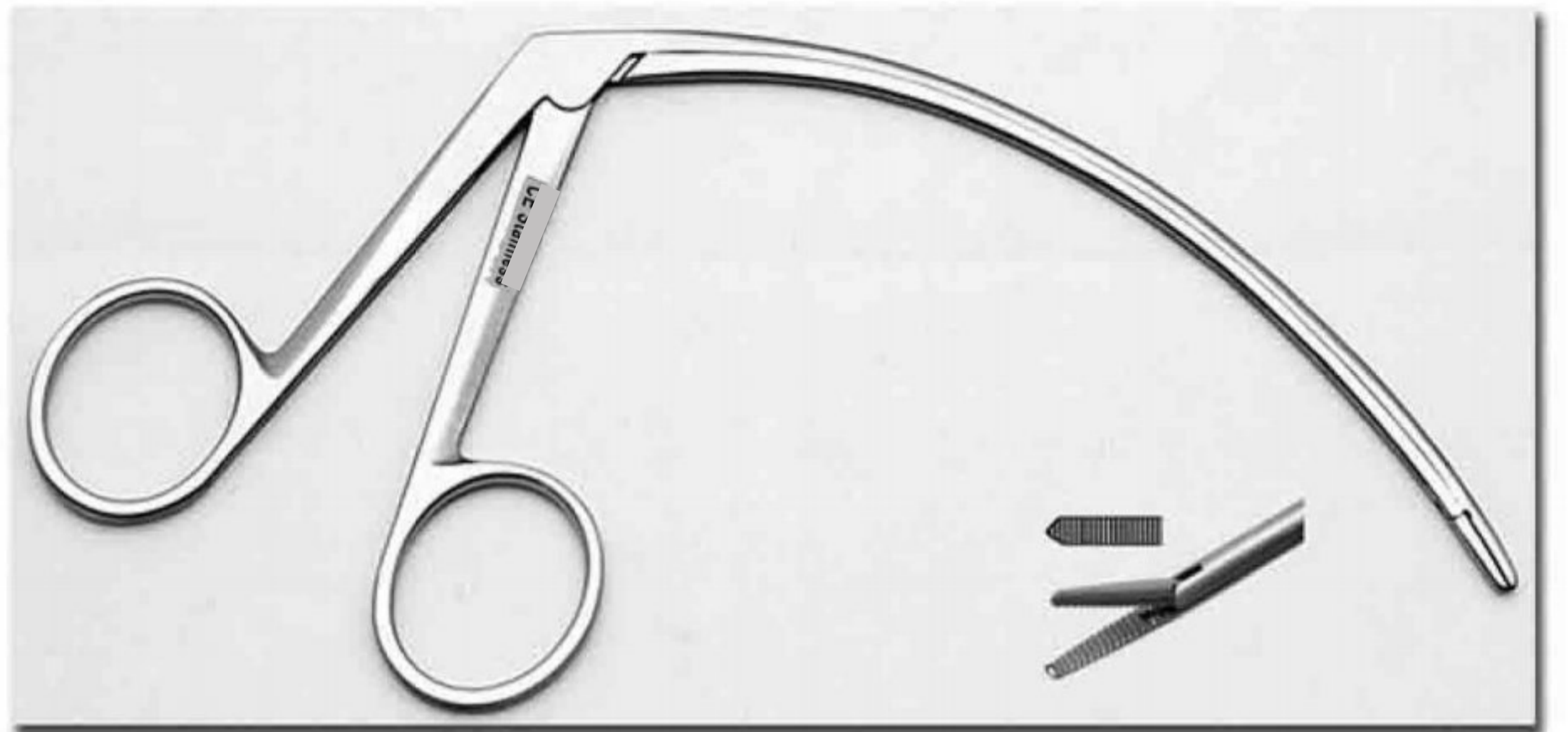

AJ-2489
Carroll Tendon Holding Forceps 11.5 cm / 4 1/2"

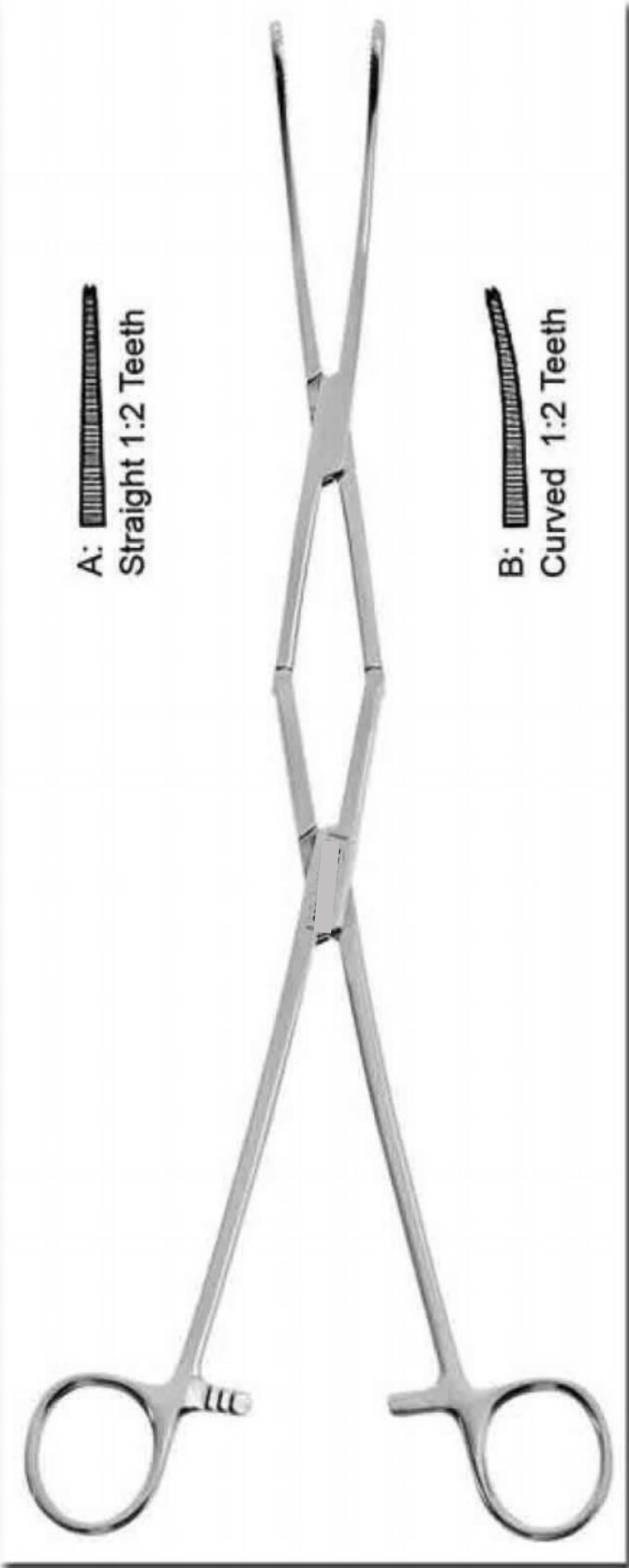

AJ-2490
Hallman Tendon Tunnelling Forceps
21 cm / 8 1/4"

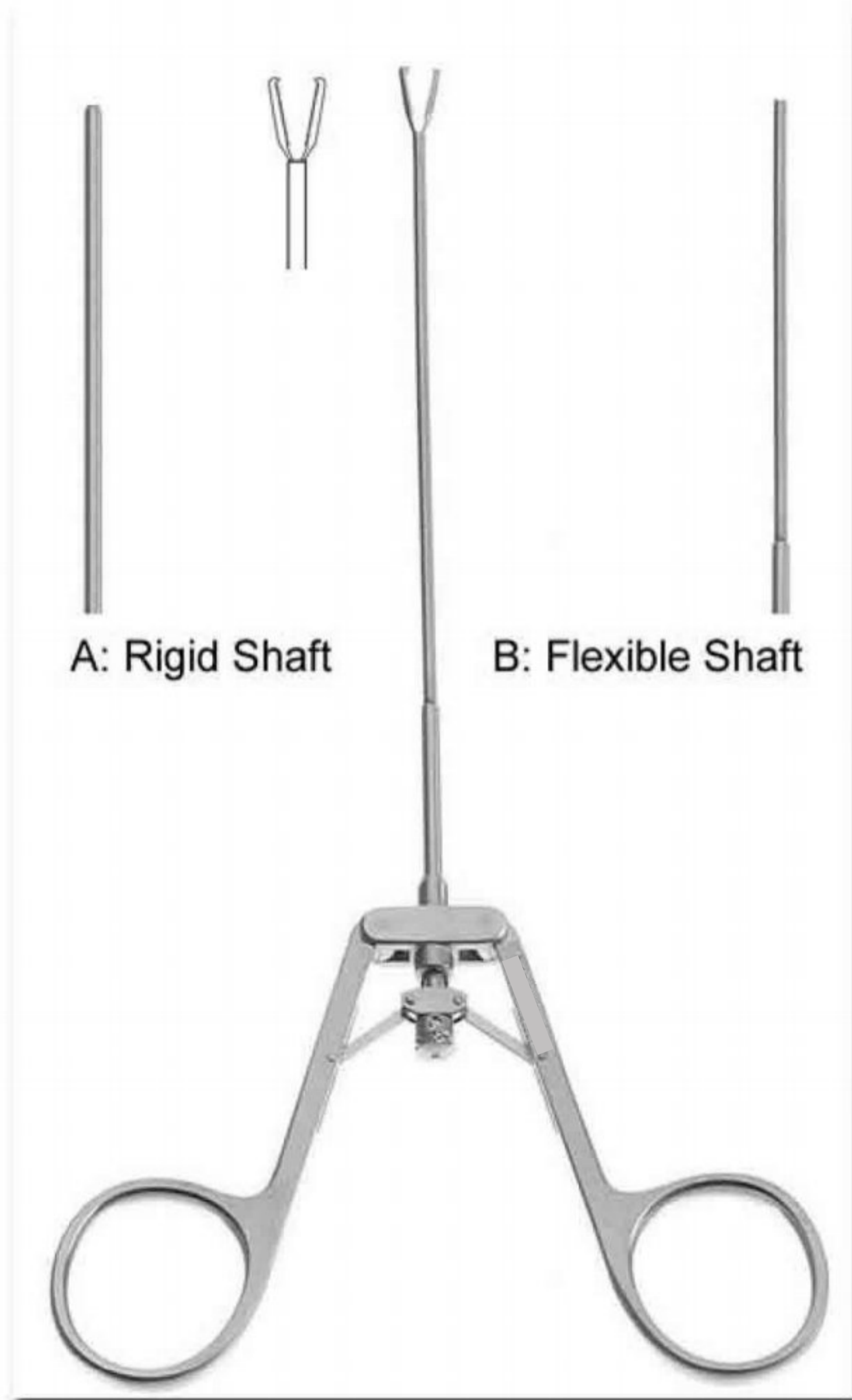

AJ-2491
Kleinert-Kutz Tendon Holding Forceps
21 cm / 8 1/4" 1X2 teeth

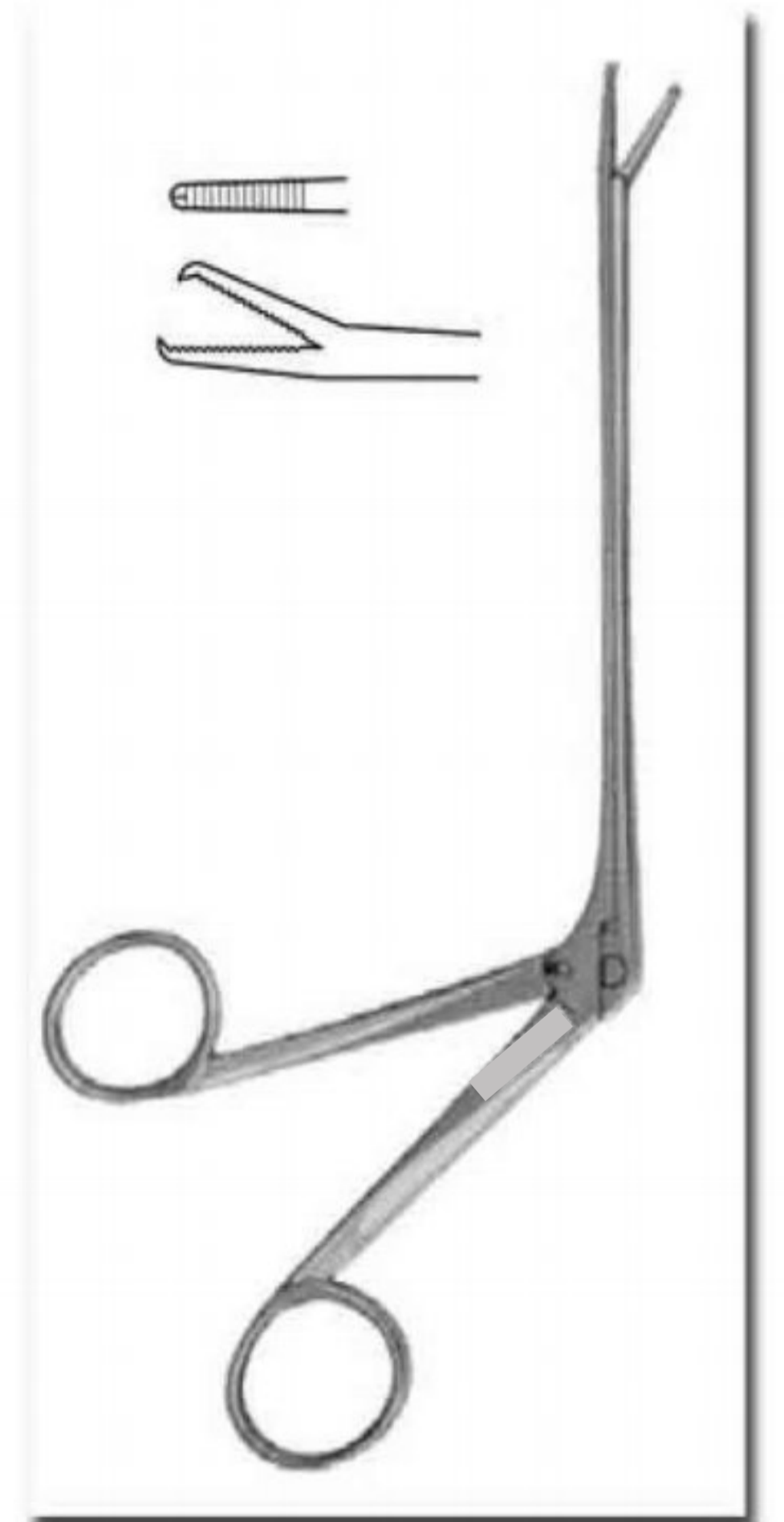

AJ-2492
Hoen Grasping Forceps
14 cm / 5 1/2" (Shaft)
1X2 teeth

BONE GRASPERS - MENISCUS CLAMPS

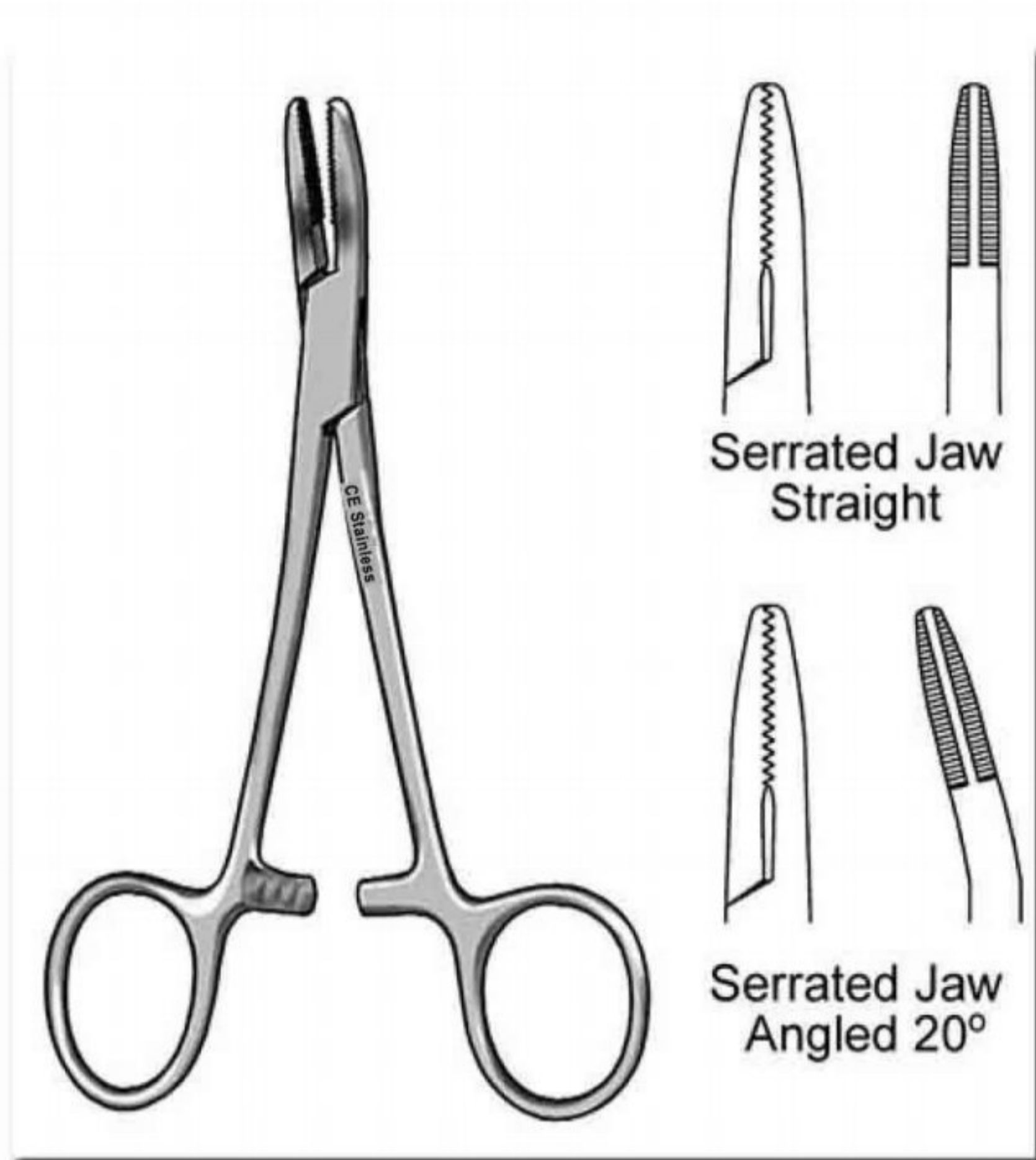

AJ-2493

Meniscus Clamp
13.5 cm / 5 3/8" 1X2 teeth

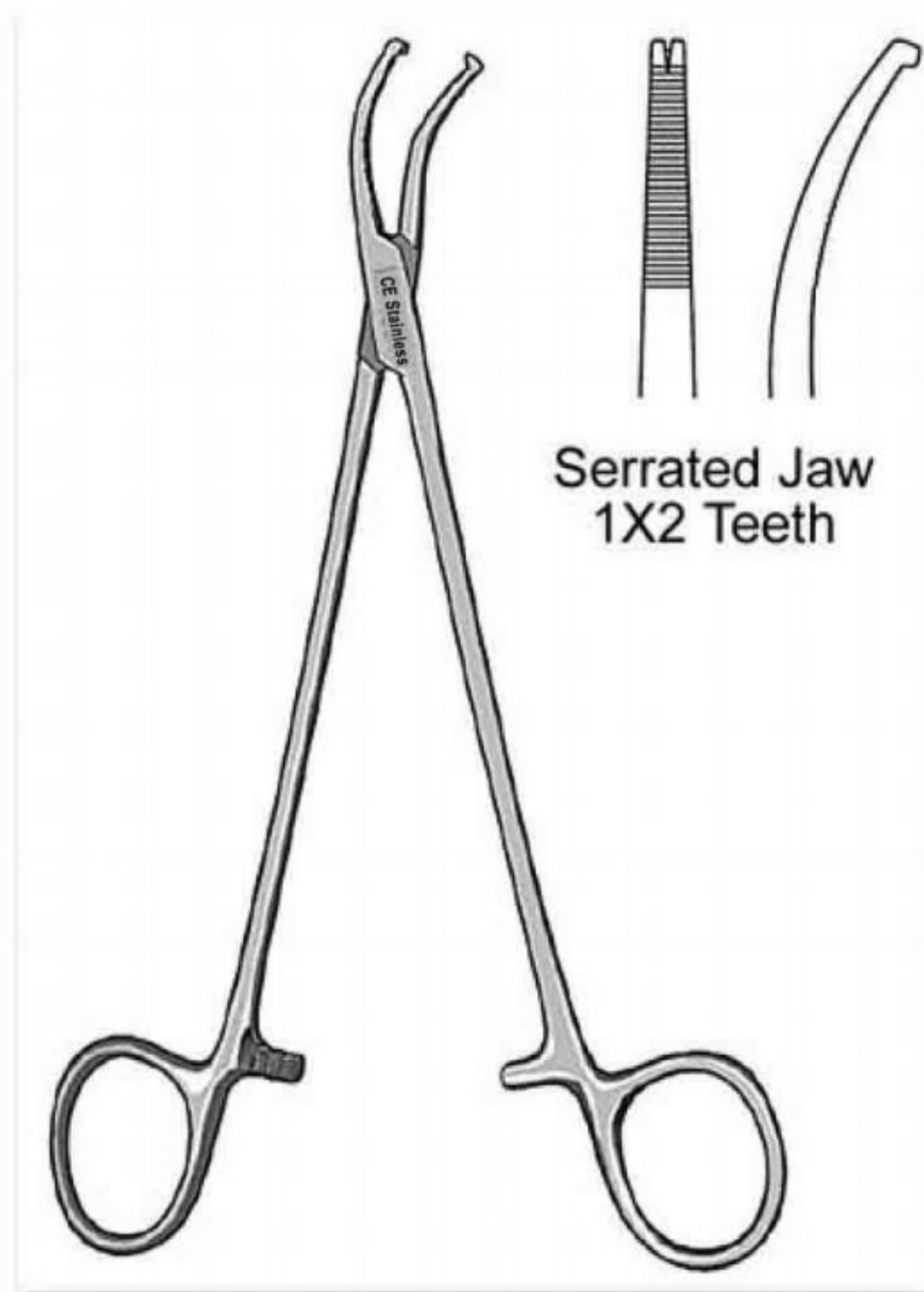

AJ-2494

Preston Ligamentum Flavum Forceps
(Meniscus) 18.5 cm / 7 1/4"



Straight

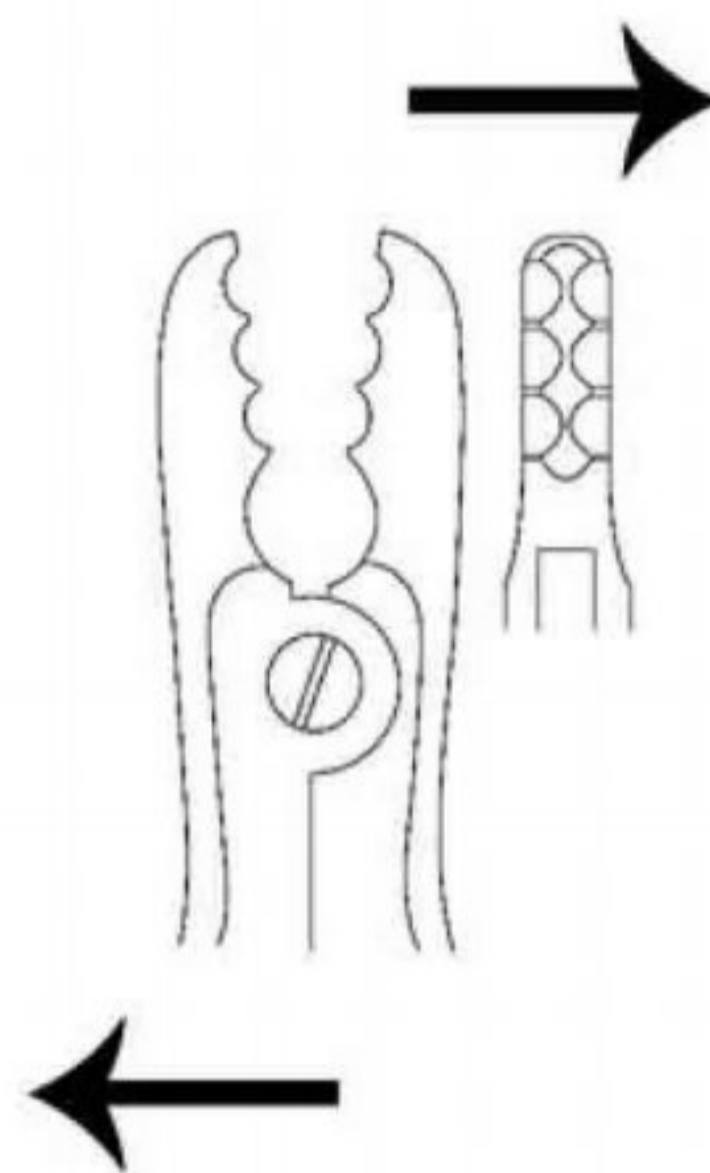

Angled

AJ-2494

Ortho Grasper 21 cm / 8 1/2"
7 X 20 MM Bite

PELVIC REDUCTION INSTRUMENTS

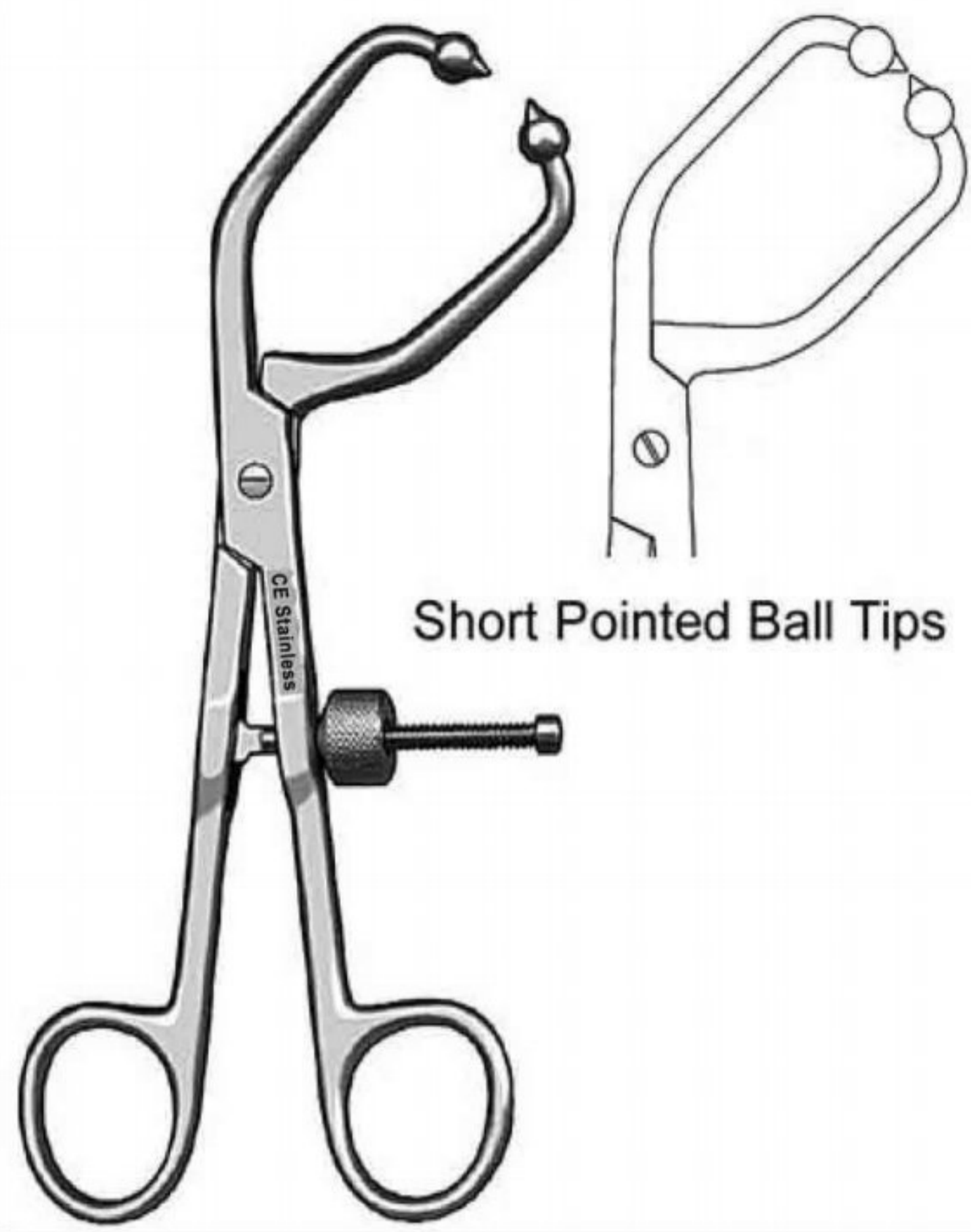

AJ-2495 Pelvic Reduction Forceps
19 cm / 7 3/8" Angular

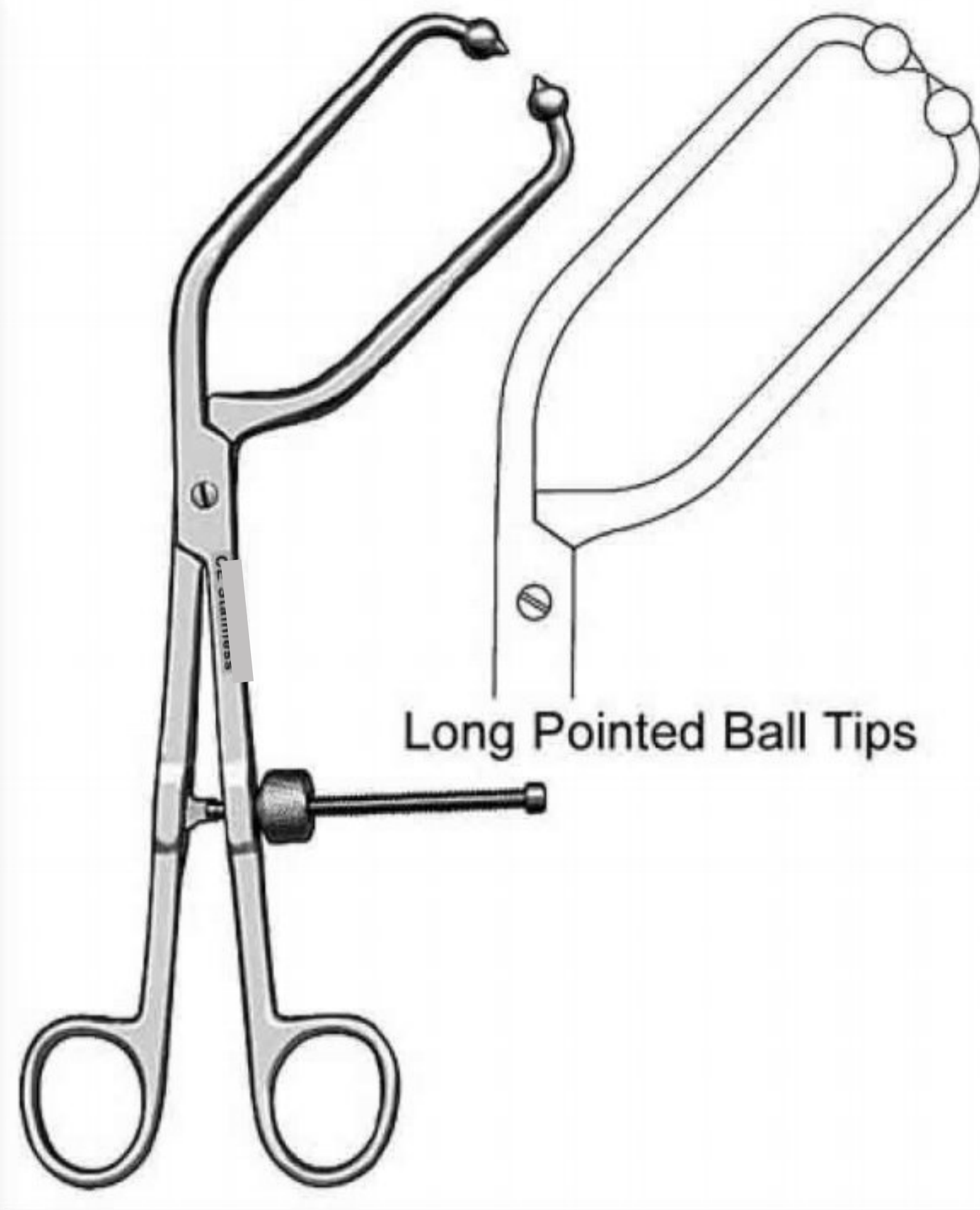

AJ-2496 Pelvic Reduction Forceps
24.5 cm / 9 5/8" Angular

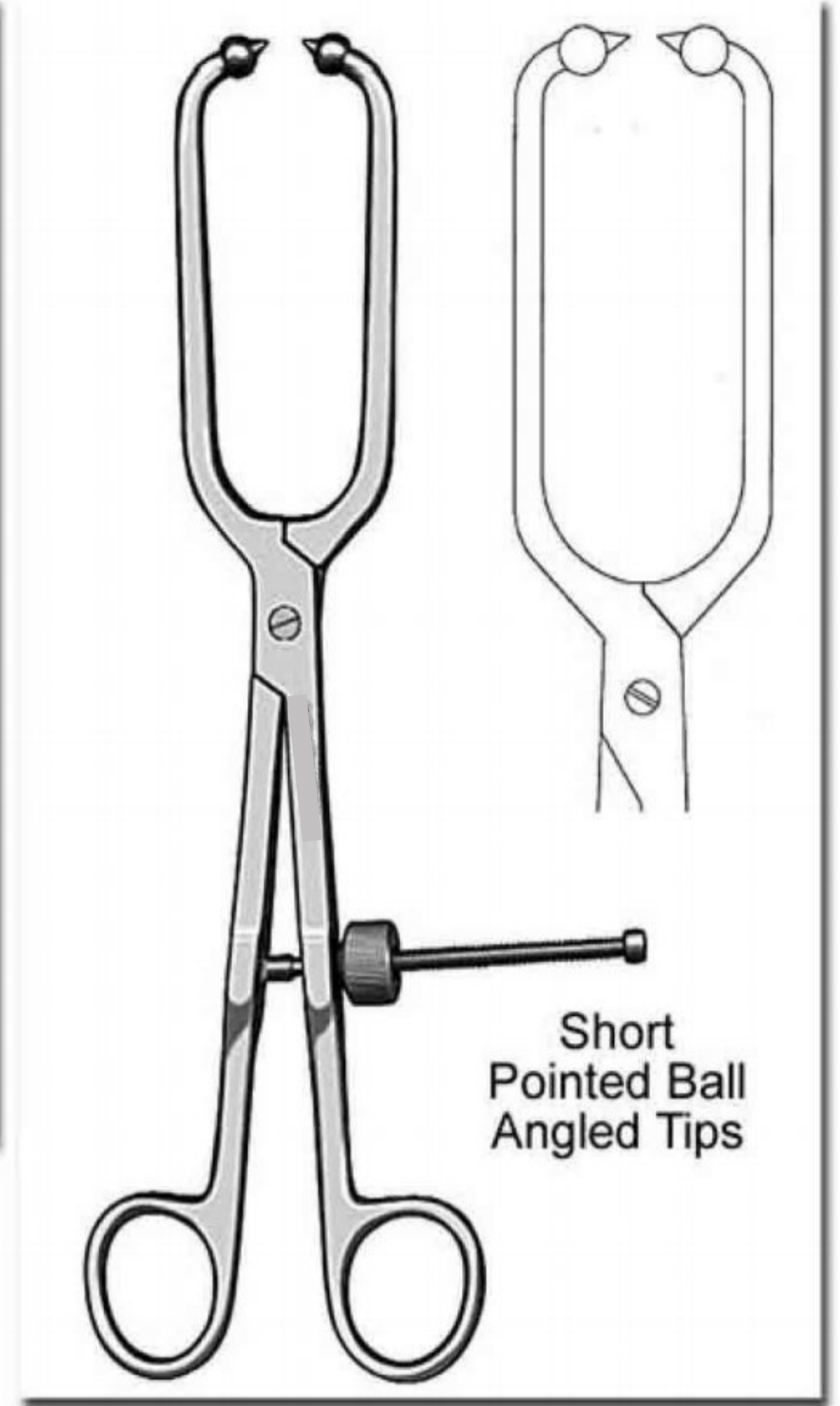

AJ-2497 Pelvic Reduction Forceps
25 cm / 10"

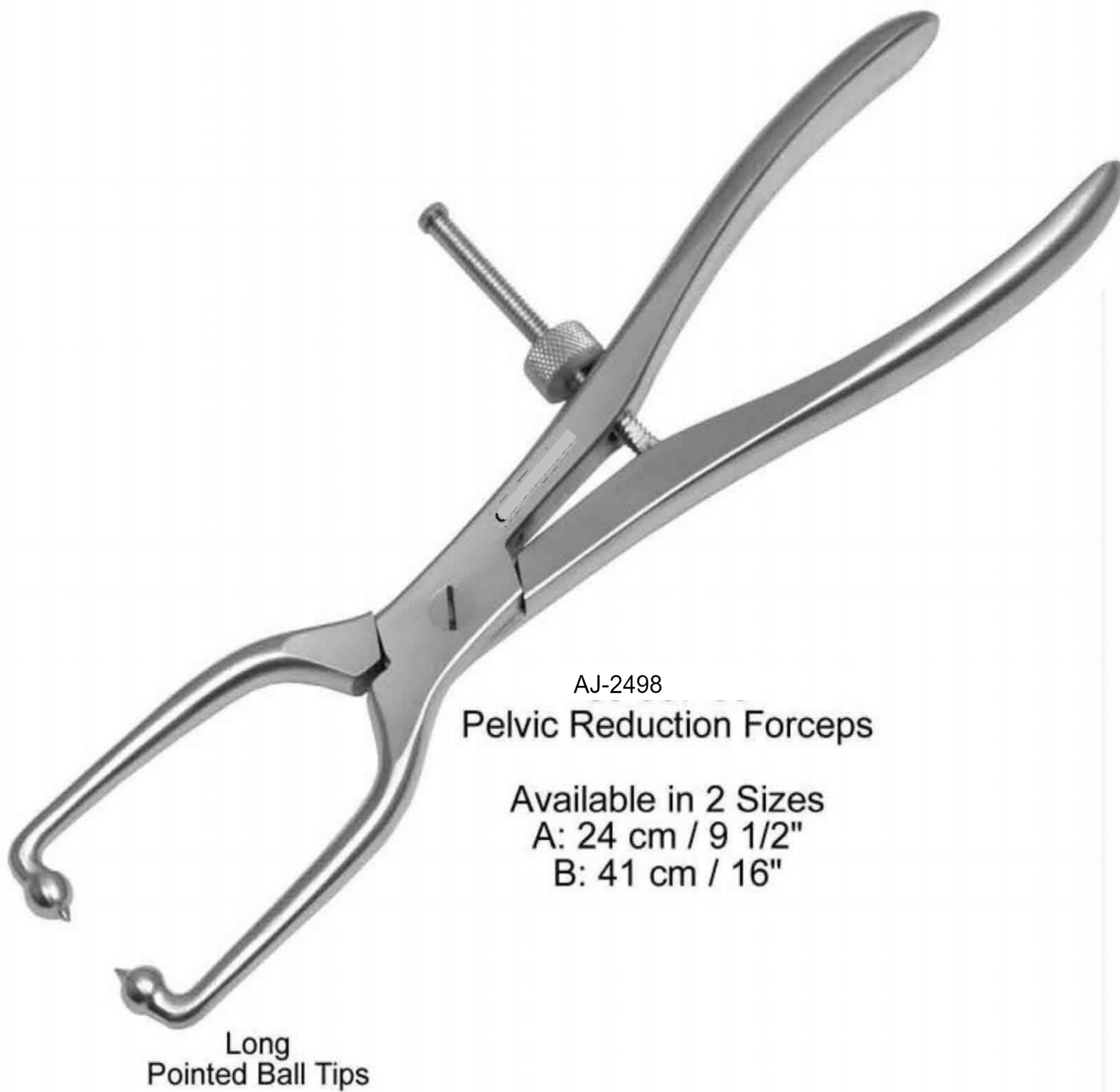

AJ-2498 Pelvic Reduction Forceps

Available in 2 Sizes
A: 24 cm / 9 1/2"
B: 41 cm / 16"

Long Pointed Ball Tips

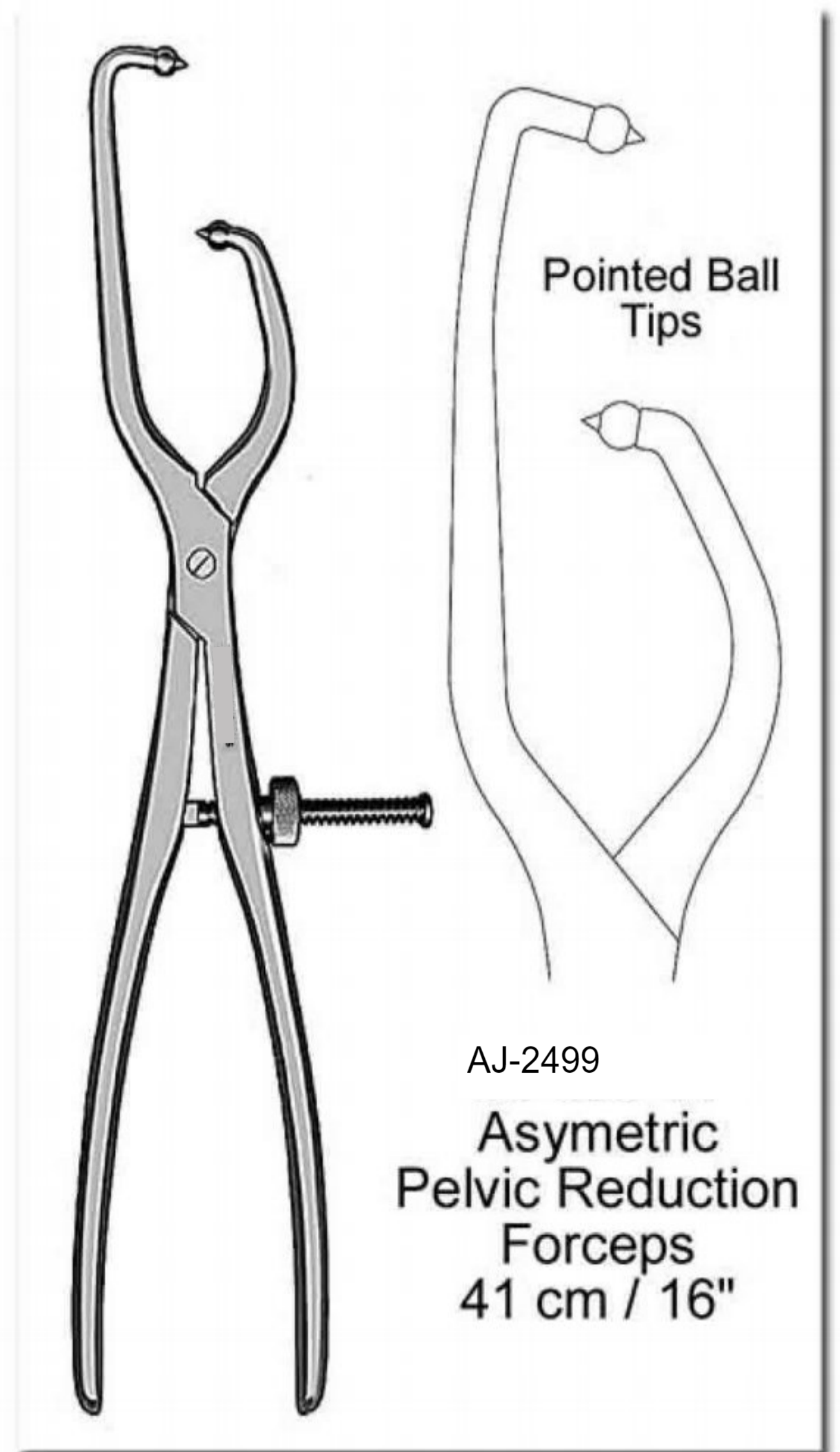

AJ-2499 Asymmetric Pelvic Reduction Forceps
41 cm / 16"

PELVIC REDUCTION INSTRUMENTS

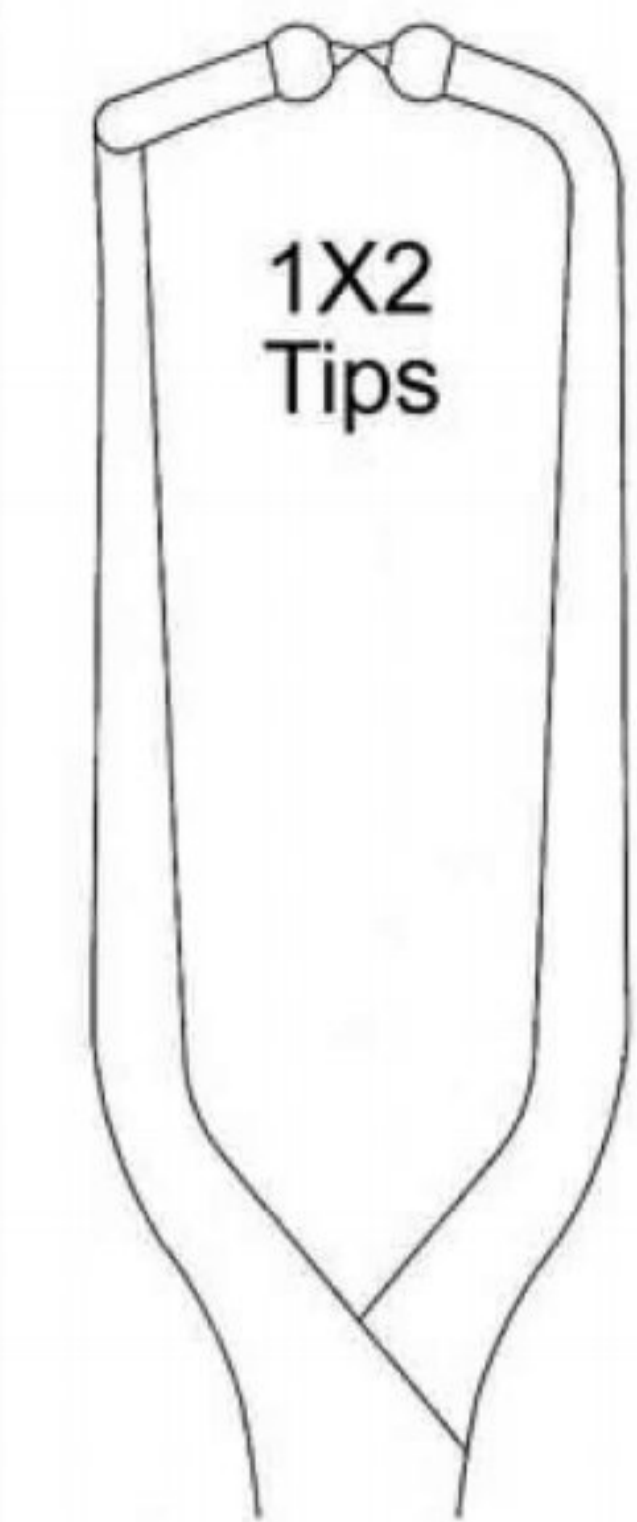
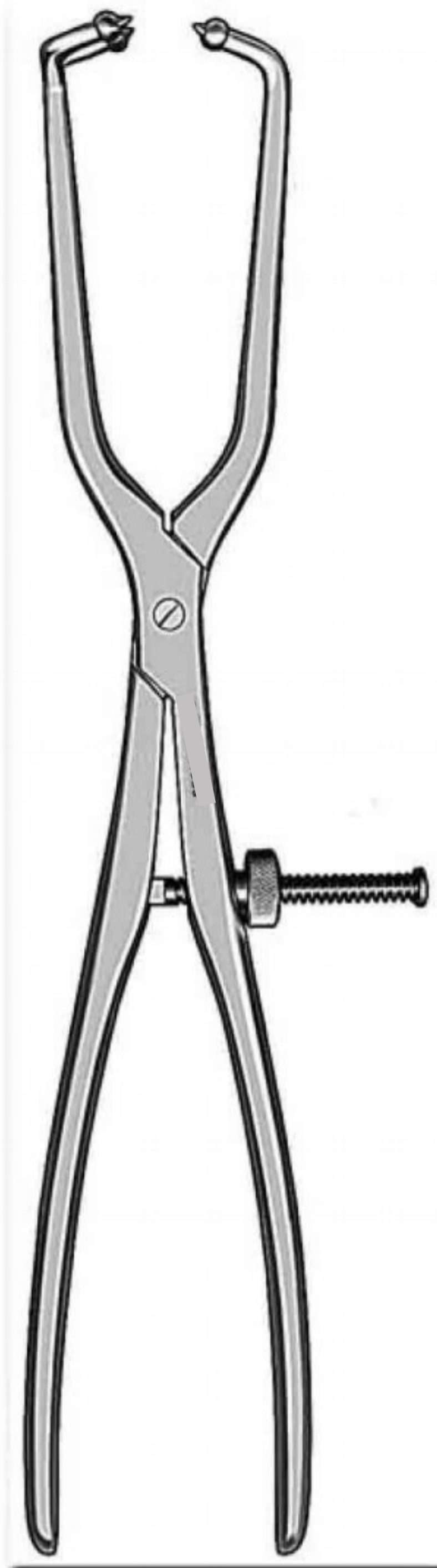

AJ-2500
Pelvic Reduction Forceps
Long 1X2
Pointed Ball Tips
41 cm / 16"



AJ-2501
Periarticular
Reduction Forceps
Straight
Pointed Ball Tips
38 cm / 15"

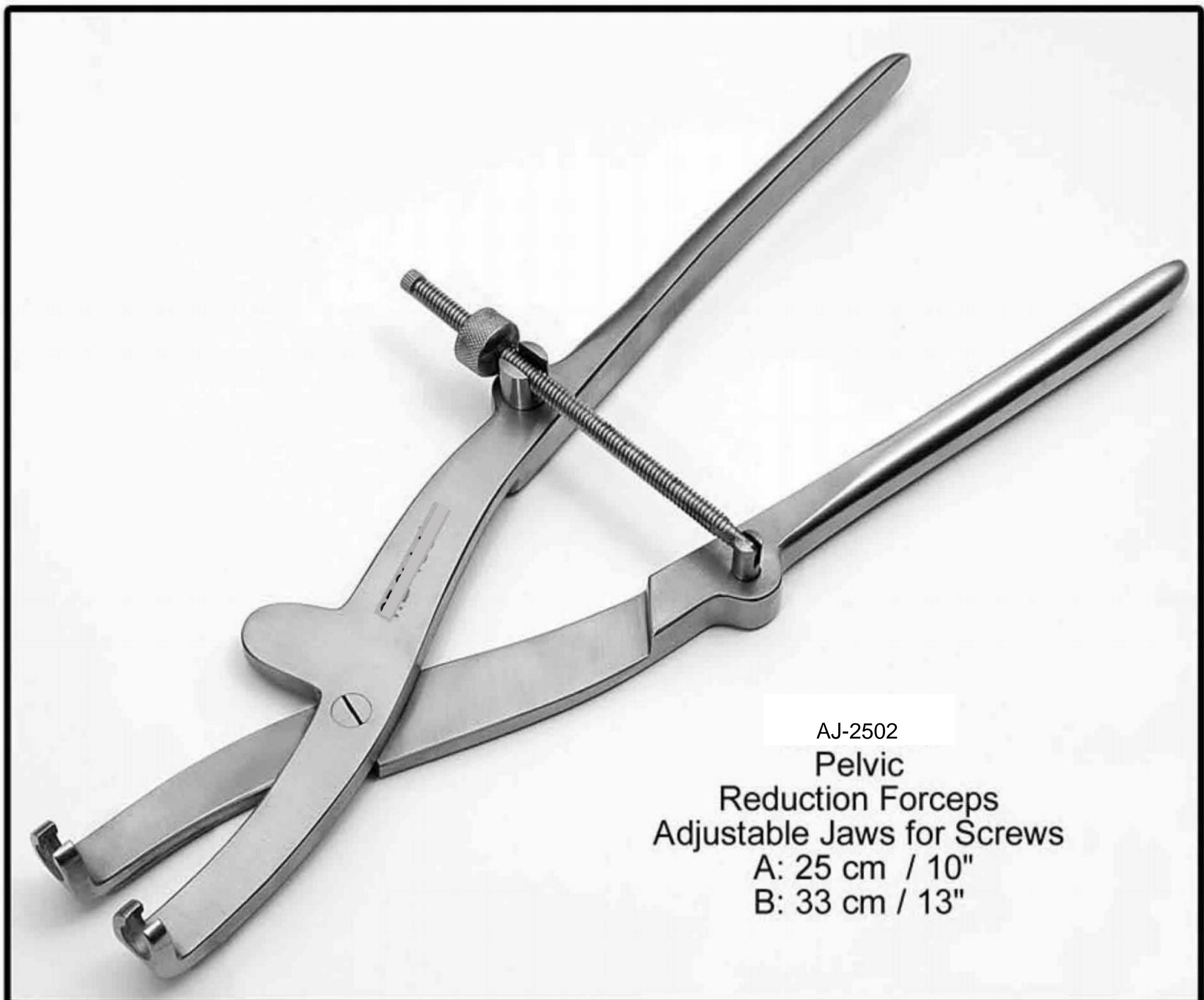

AJ-2502
Pelvic
Reduction Forceps
Adjustable Jaws for Screws
A: 25 cm / 10"
B: 33 cm / 13"

BONE HOLDING FORCEPS

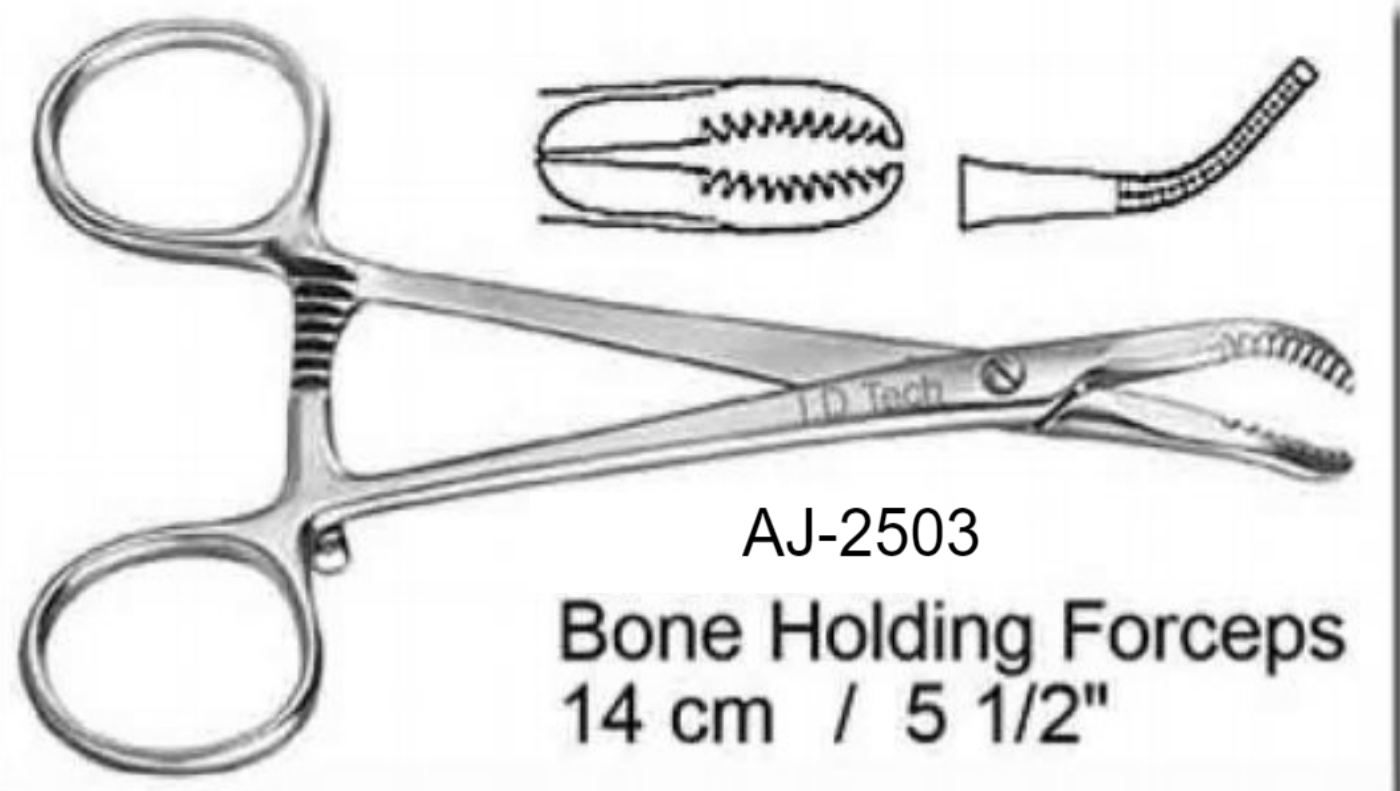

AJ-2503
Bone Holding Forceps
14 cm / 5 1/2"



AJ-2504
Lewin Bone Holding Forceps
18.5cm / 7 1/4"



AJ-2505
Bone Holding Forceps
14 cm / 5 1/2"
Delicate



AJ-2506 Frosch Bone Holding Forceps
18 cm / 7"



AJ-2507 Bone Holding Forceps
20 cm / 8"



AJ-2508 Semb Bone Holding Forceps
19 cm / 7 1/2"



AJ-2509 Langenbeck Bone Holding Forceps
21 cm / 8 1/4"

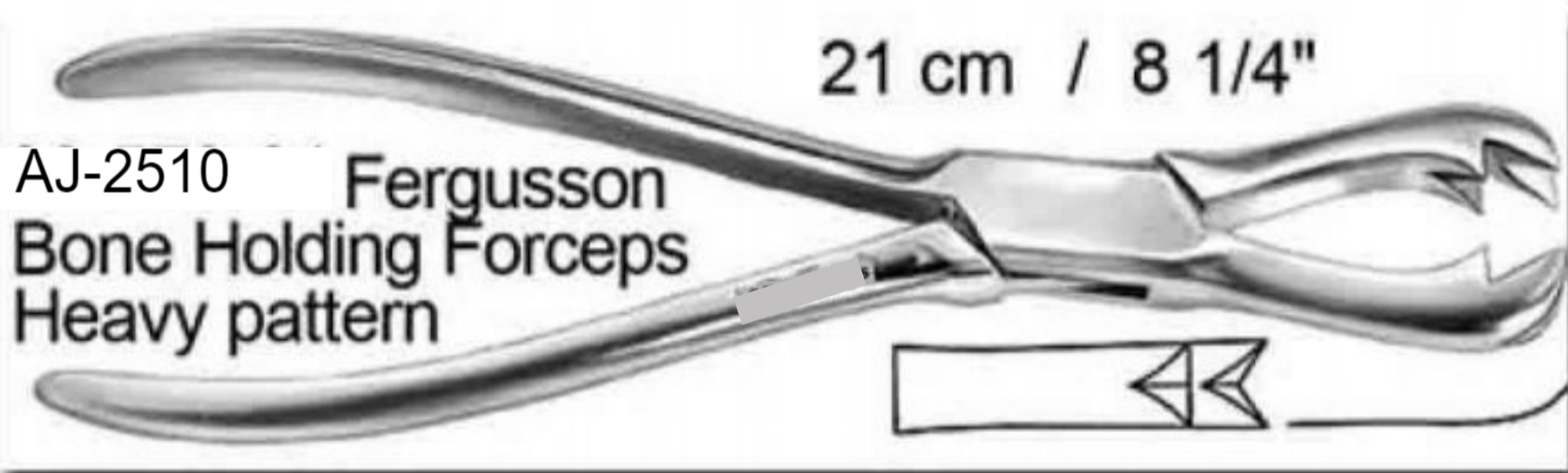

AJ-2510 Fergusson Bone Holding Forceps
Heavy pattern
21 cm / 8 1/4"

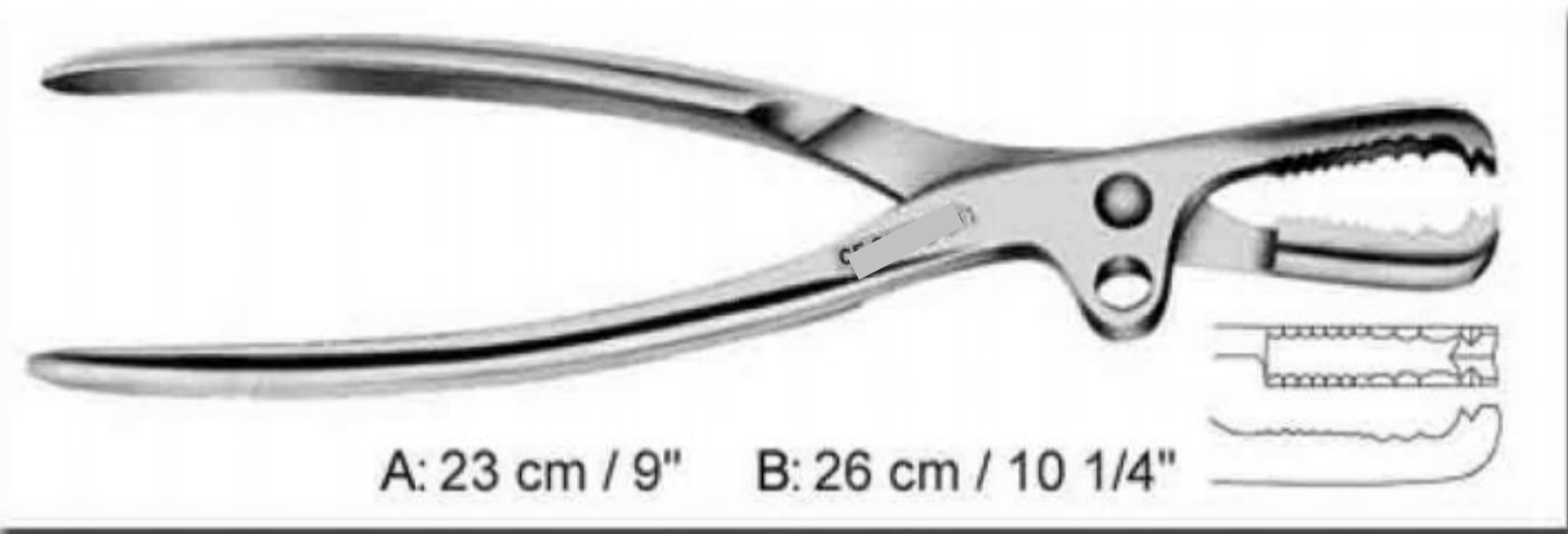

AJ-2511 Farabeuf Bone Holding Forceps
A: 23 cm / 9" B: 26 cm / 10 1/4"



AJ-2512 Kern Bone Holding Forceps
A: 17 cm / 6 3/4"
B: 21 cm / 8 1/4"



AJ-2512 Farabeuf Lambotte Bone Holding Forceps
A: 23 cm / 9"
B: 26 cm / 10"
Adjustable / With Ratchet

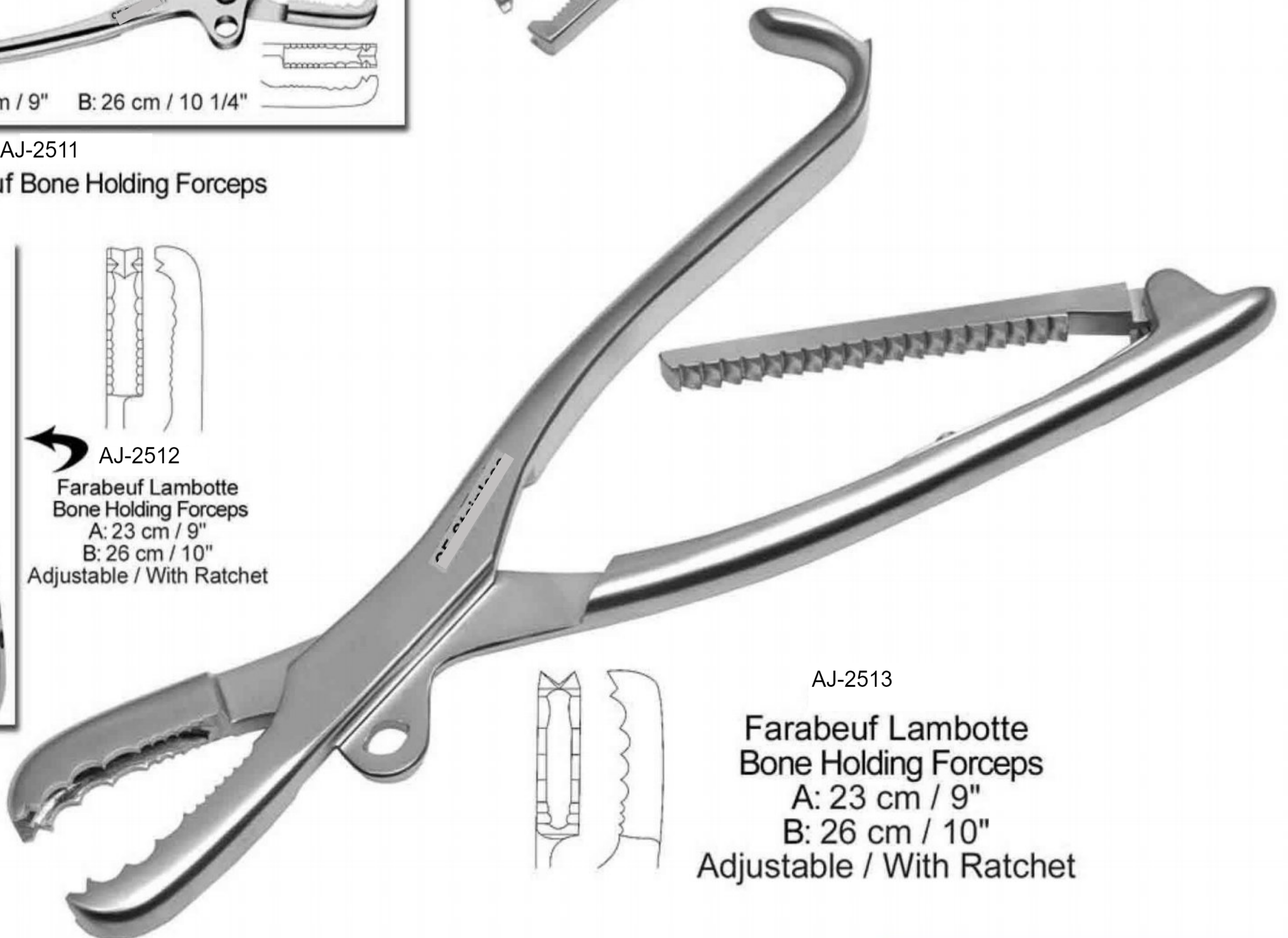

AJ-2513 Farabeuf Lambotte Bone Holding Forceps
A: 23 cm / 9"
B: 26 cm / 10"
Adjustable / With Ratchet

BONE HOLDING FORCEPS

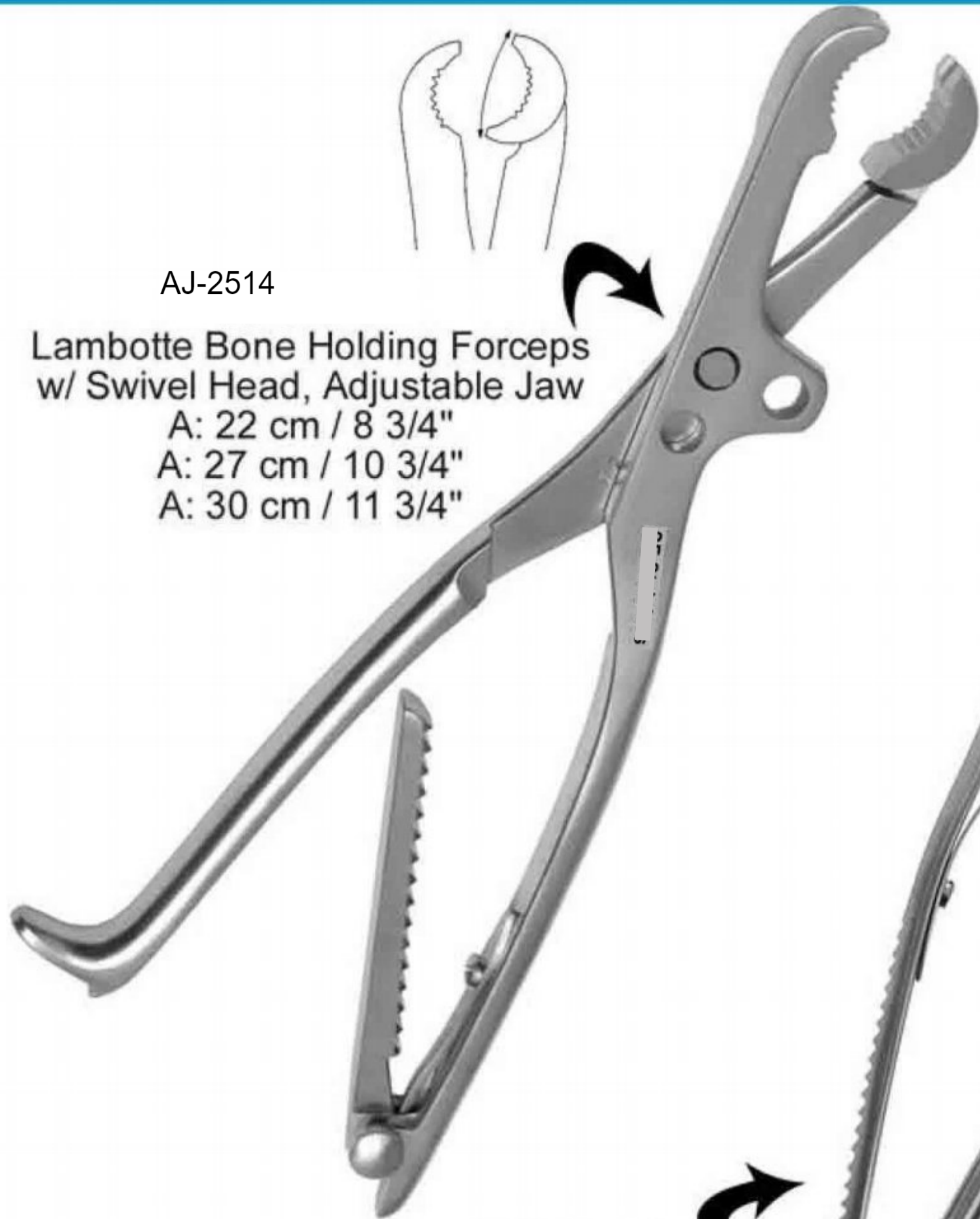

AJ-2514

Lambotte Bone Holding Forceps
w/ Swivel Head, Adjustable Jaw

- A: 22 cm / 8 3/4"
- A: 27 cm / 10 3/4"
- A: 30 cm / 11 3/4"

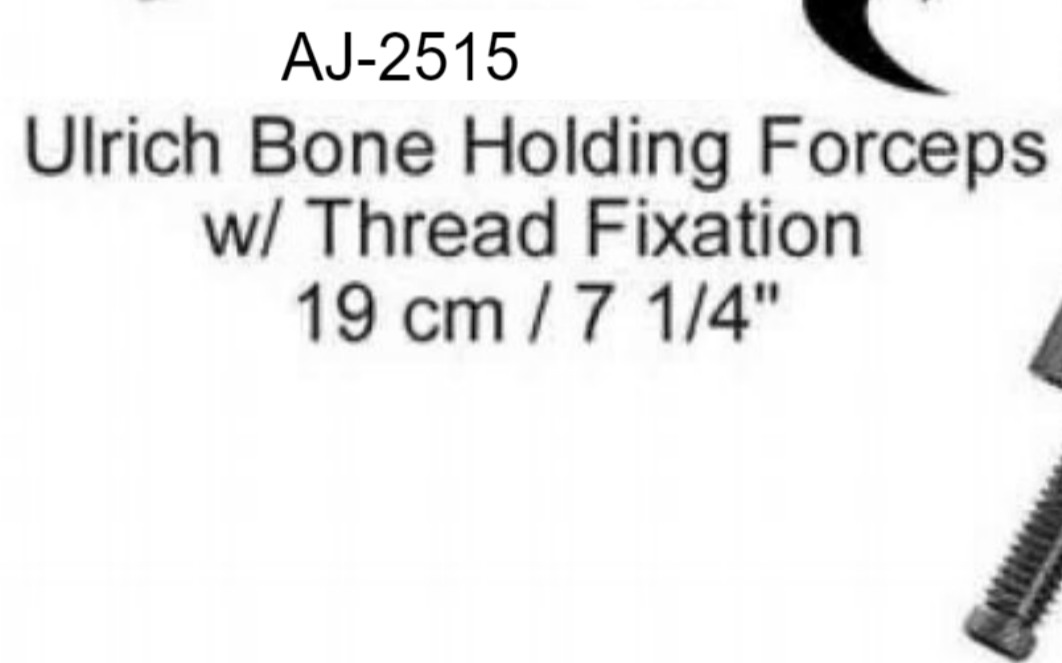

AJ-2515

Ulrich Bone Holding Forceps
w/ Thread Fixation
19 cm / 7 1/4"

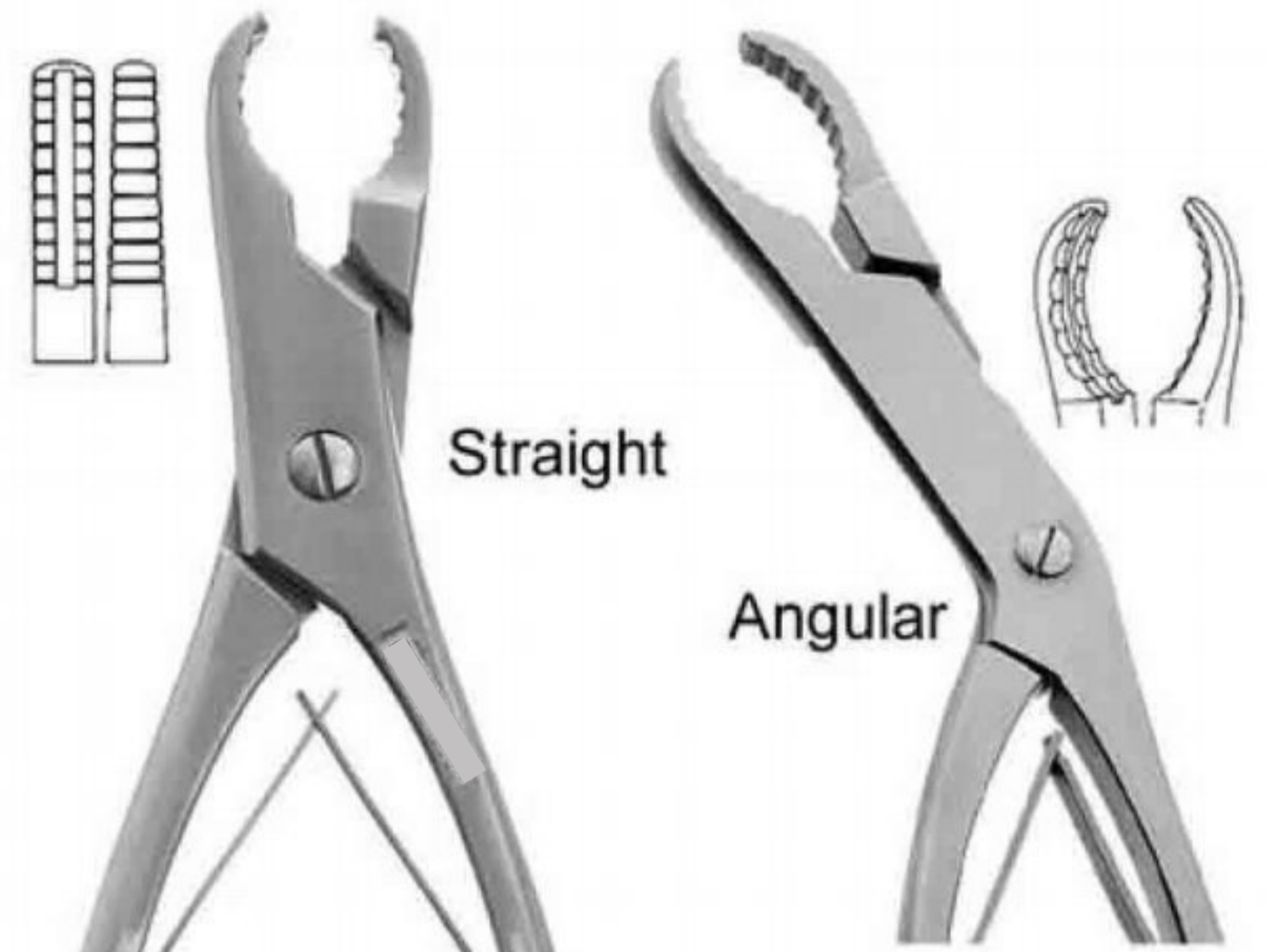

Straight

Angular

AJ-2516

Ulrich
Bone Holding
Forceps
w/ Thread Fixation
A: 23 cm / 9"
A: 25 cm / 9 3/4"
A: 28 cm / 11"



AJ-2517

Self Centering
Bone Holding
Forceps
W/ Thread Fixation

- Available in:
Available in:
- A: 15 cm / 6"
 - B: 19 cm / 7 1/2"
 - C: 24 cm / 9 1/2"
 - D: 26 cm / 10 1/4"
 - E: 28 cm / 11"

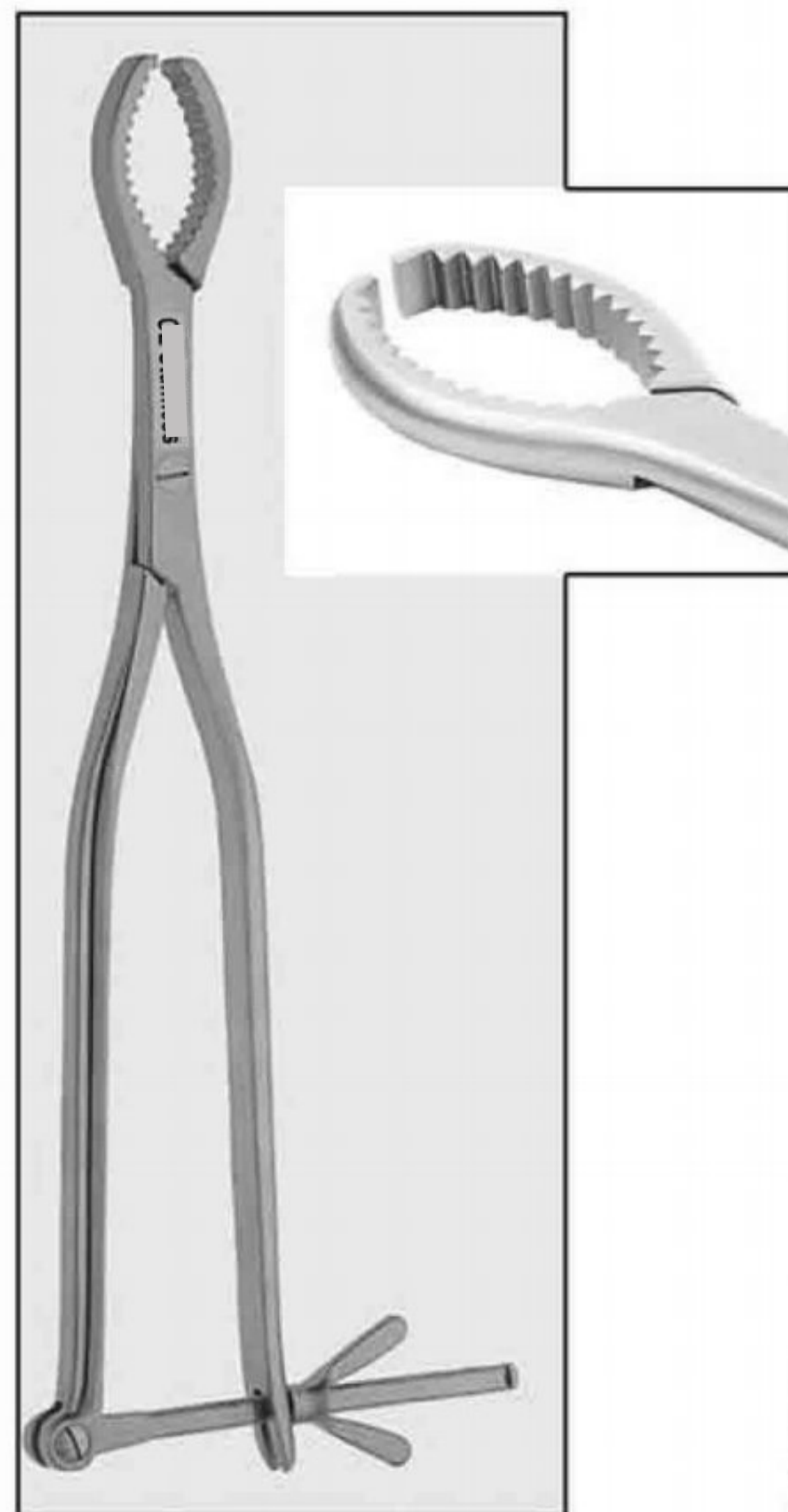

AJ-2518

Hey Groves
Bone Holding Forceps
A: 20 cm / 8"
B: 25 cm / 10"
C: 30 cm / 12"



AJ-2520

Lane Bone Holding Forceps
w/ Ratchet
A: 33 cm / 13"
B: 45 cm / 17 3/4"

AJ-2519

without
Ratchet

BONE HOLDING FORCEPS

Enlarged Tip
of 25cm Shown

AJ-2521
Verbrugge
Bone Holding Forceps
A: 17.5 cm / 7"
B: 25 cm / 9 3/4"
C: 26 cm / 10 1/4"
D: 27 cm / 10 3/4"

AJ-2521
Smooth Jaws
Bone Holding Forceps
23 cm / 9"

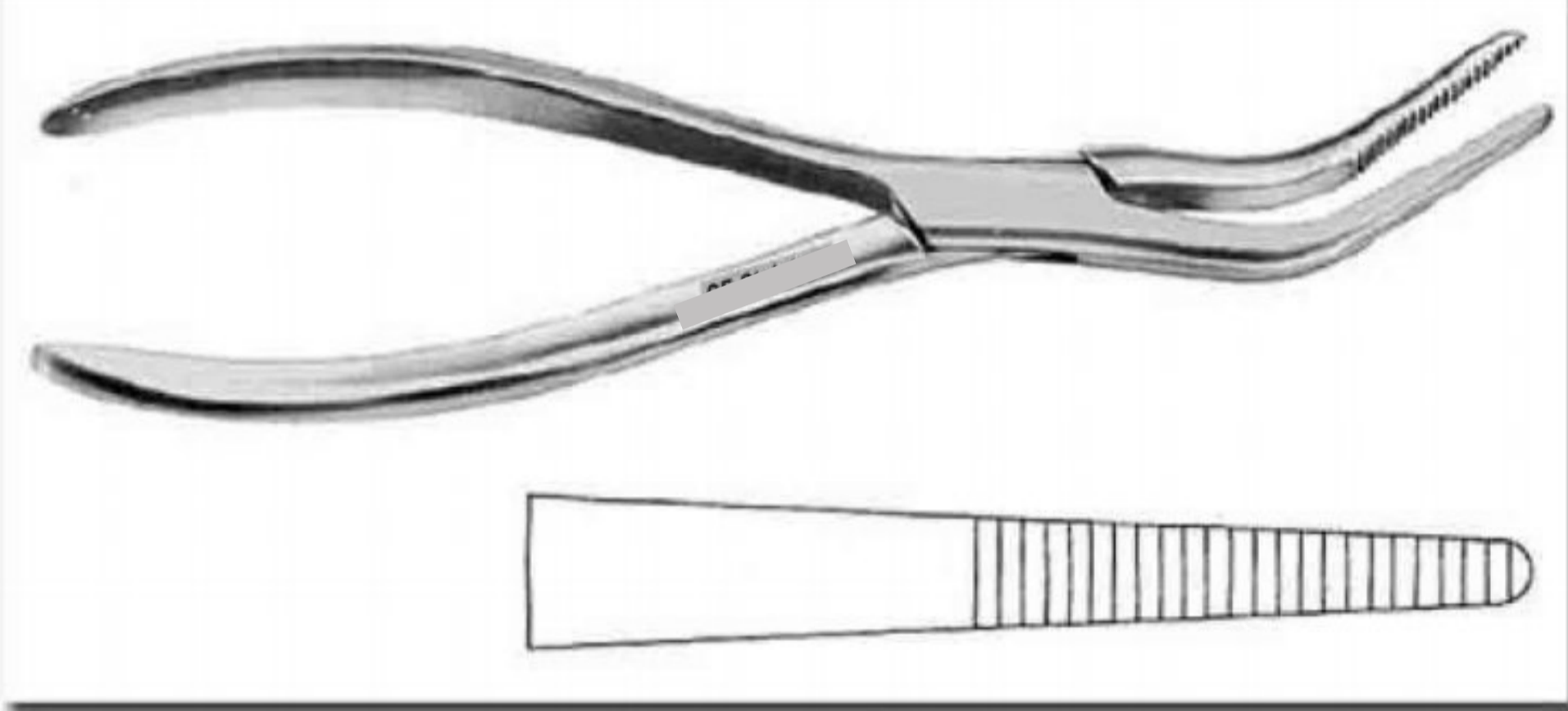

AJ-2522
Van Buren Bone Holding Forceps 21.5 cm / 8 1/2"

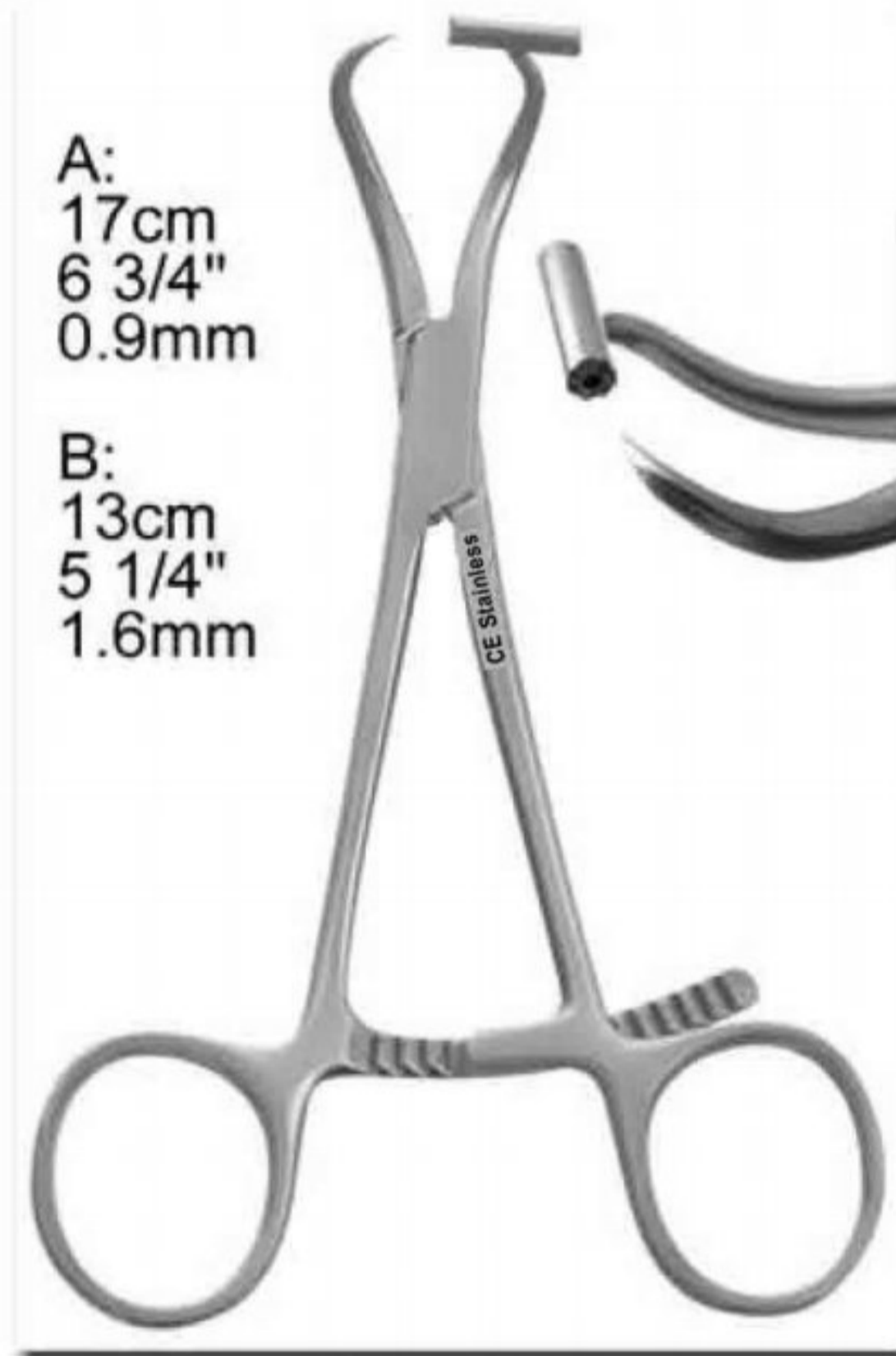

AJ-2523
Bone Holding Forceps

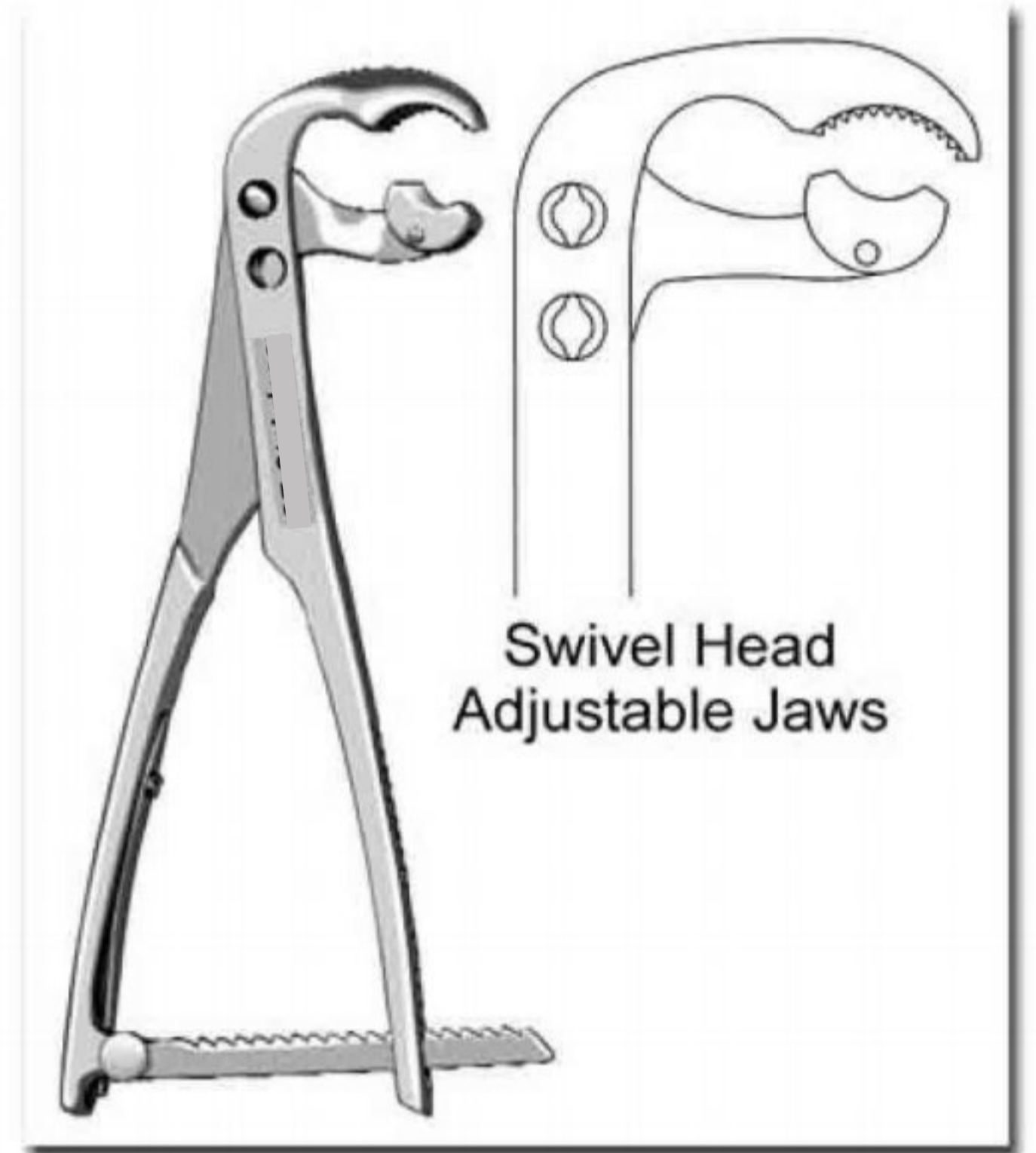

AJ-2524
Angled Bone Holding Forceps
23 cm / 9"



AJ-2525
Bishop Bone Holding Forceps
23 cm / 9"

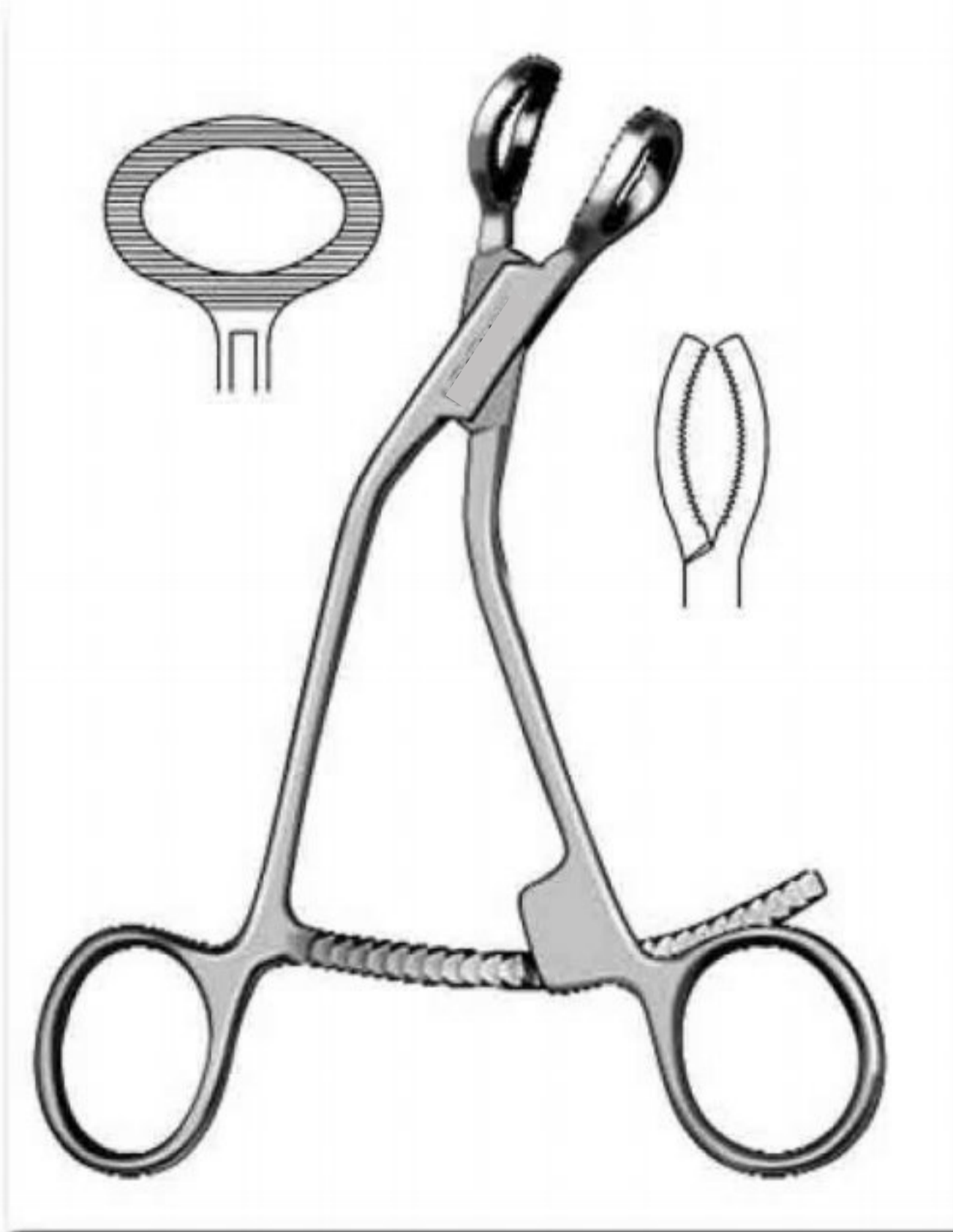

AJ-2526
Bishop Bone Holding Forceps
23 cm / 9"



AJ-2527
Patella Forceps
18 cm / 7"

CARTILAGE - REPOSITION FORCEPS



AJ-2528
Walton
Cartilage Seizing Forceps
20.5 cm / 8"
A: Straight
B: Upward Cvd
C: Sideward Cvd

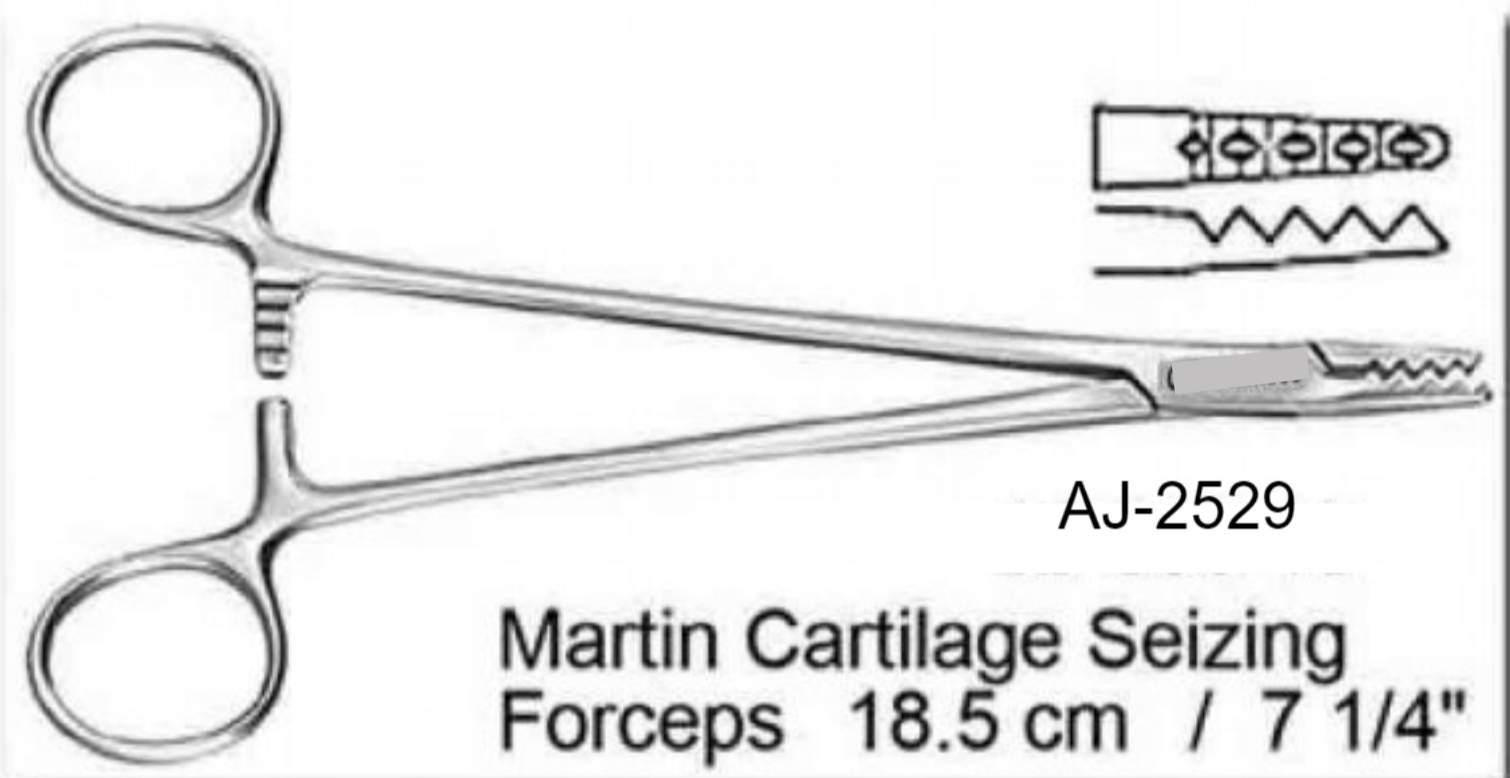
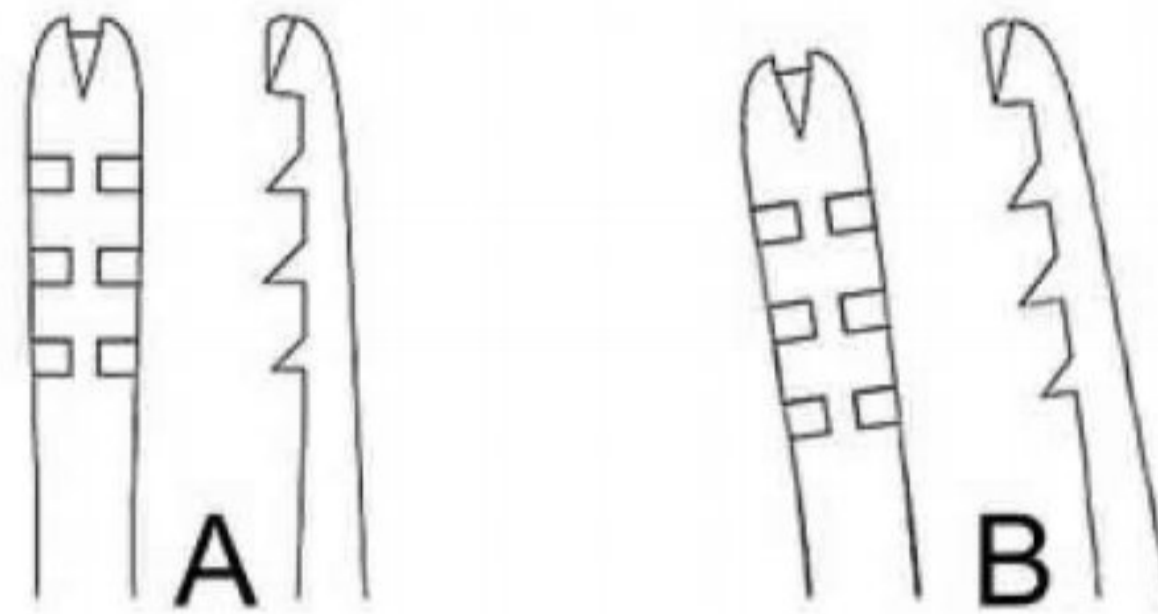

AJ-2529
Martin Cartilage Seizing
Forceps 18.5 cm / 7 1/4"

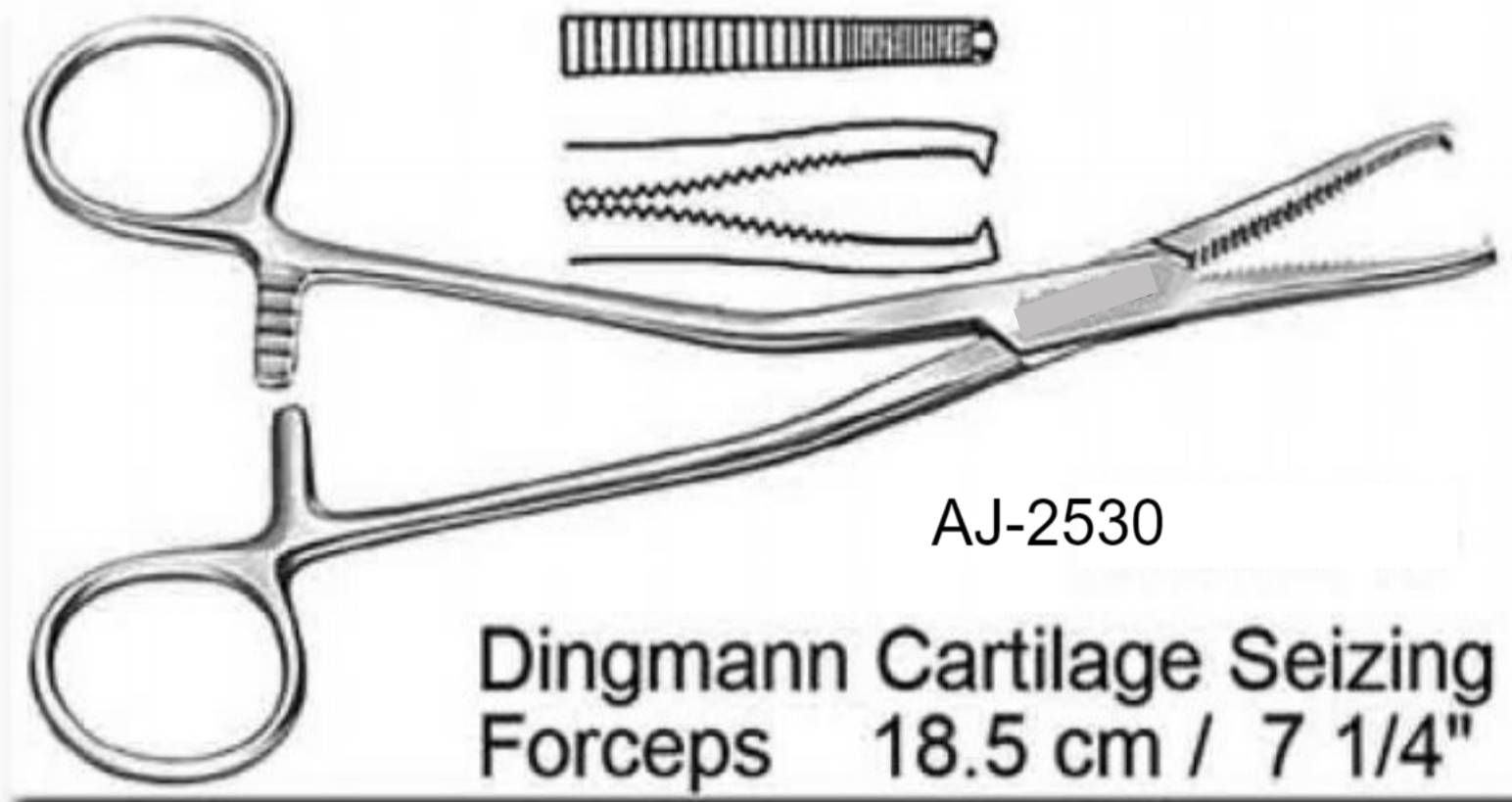

AJ-2530
Dingmann Cartilage Seizing
Forceps 18.5 cm / 7 1/4"

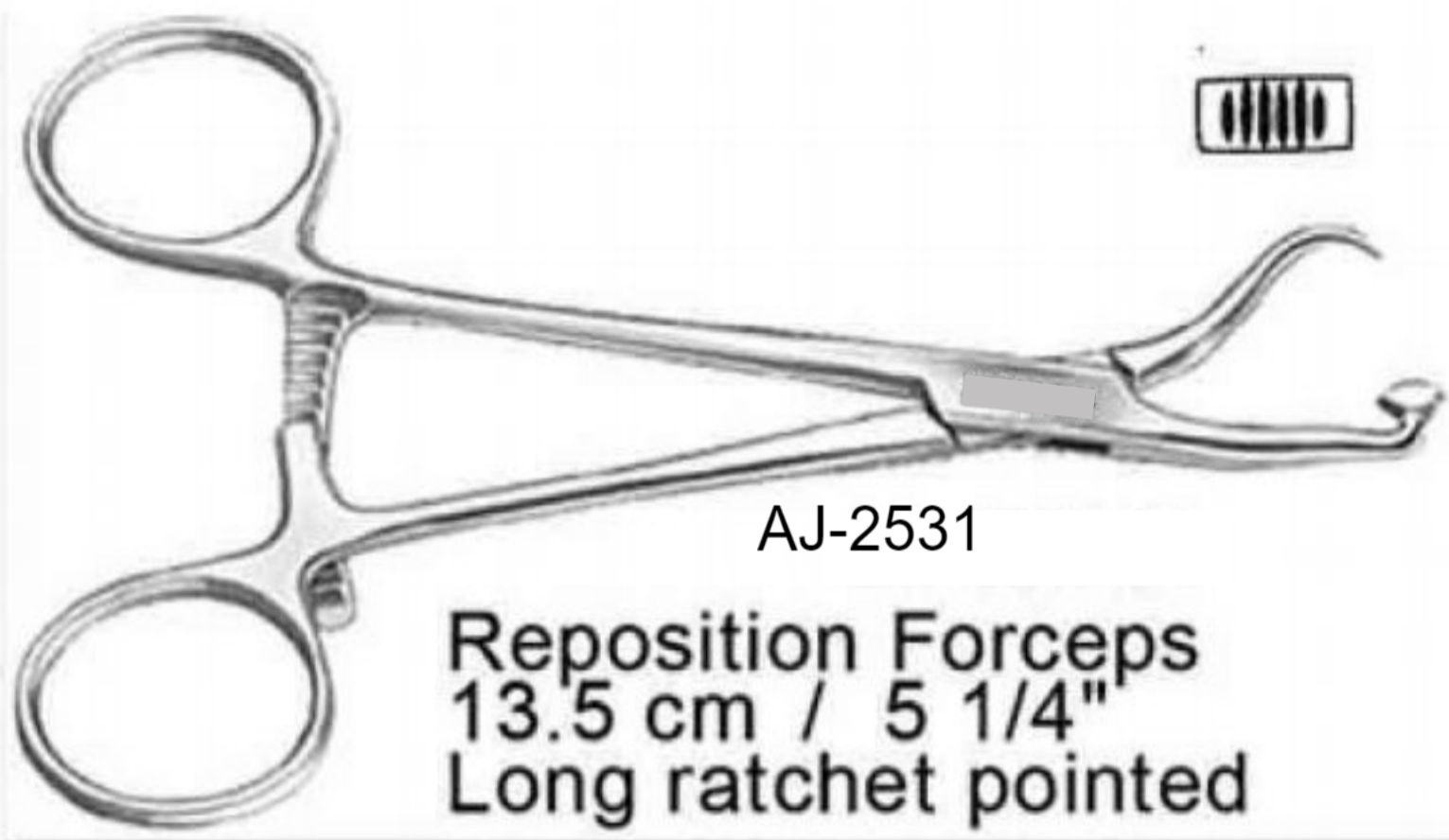

AJ-2531
Reposition Forceps
13.5 cm / 5 1/4"
Long ratchet pointed

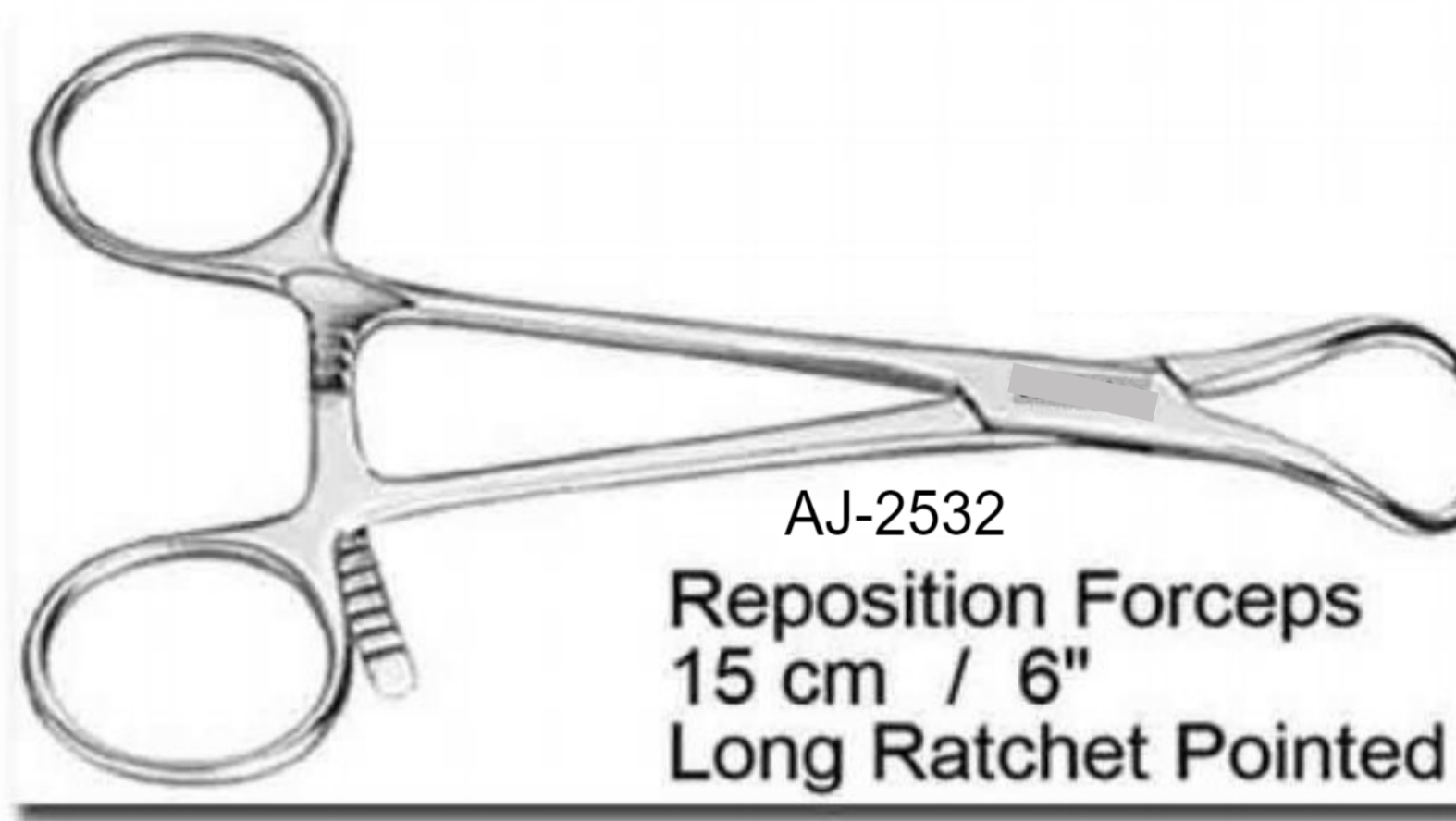

AJ-2532
Reposition Forceps
15 cm / 6"
Long Ratchet Pointed

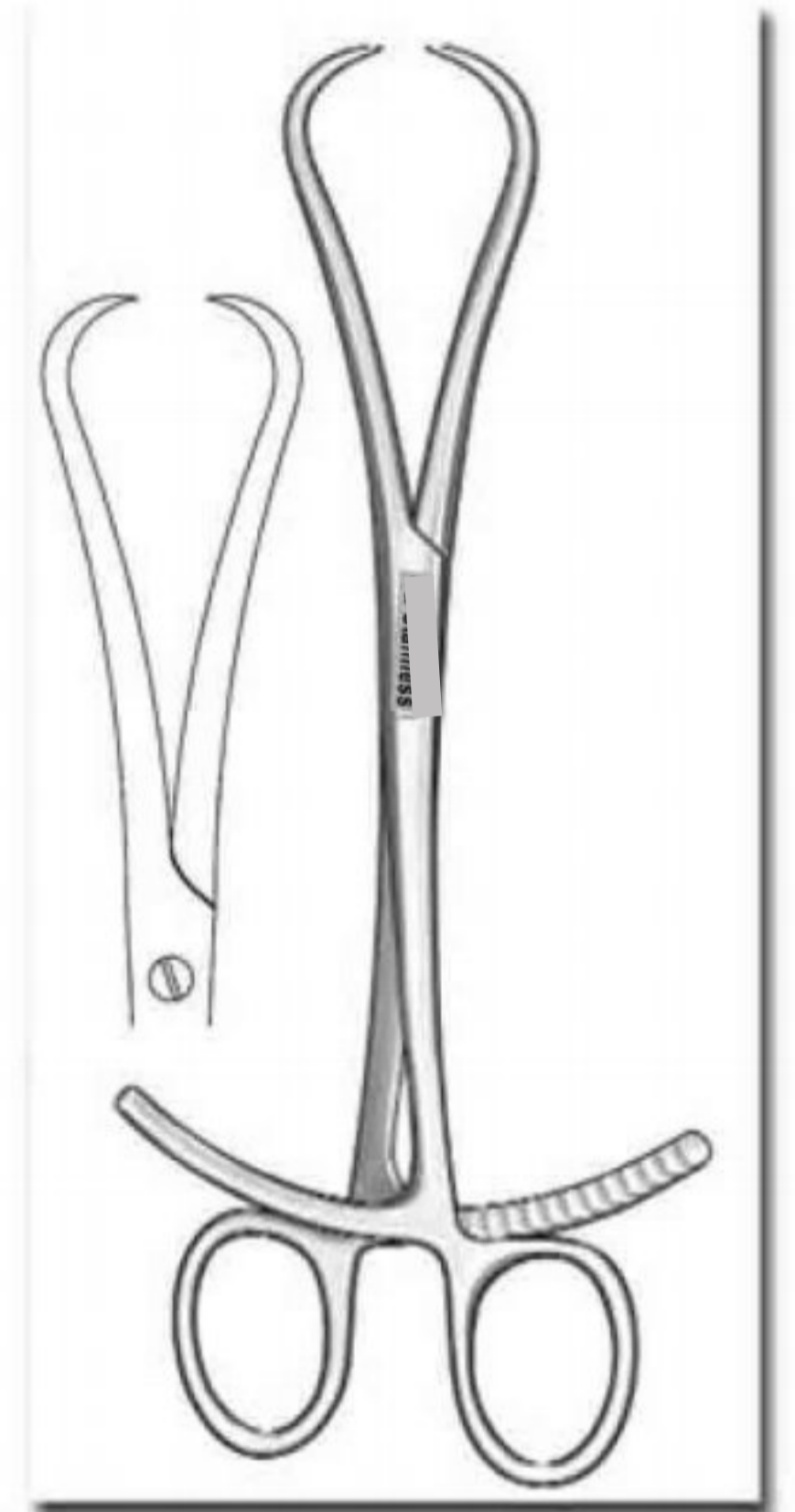

AJ-2533
Walton Bone
Reduction Forceps
20.5 cm / 8"
2" Double Ratchet
Opening 9-100mm

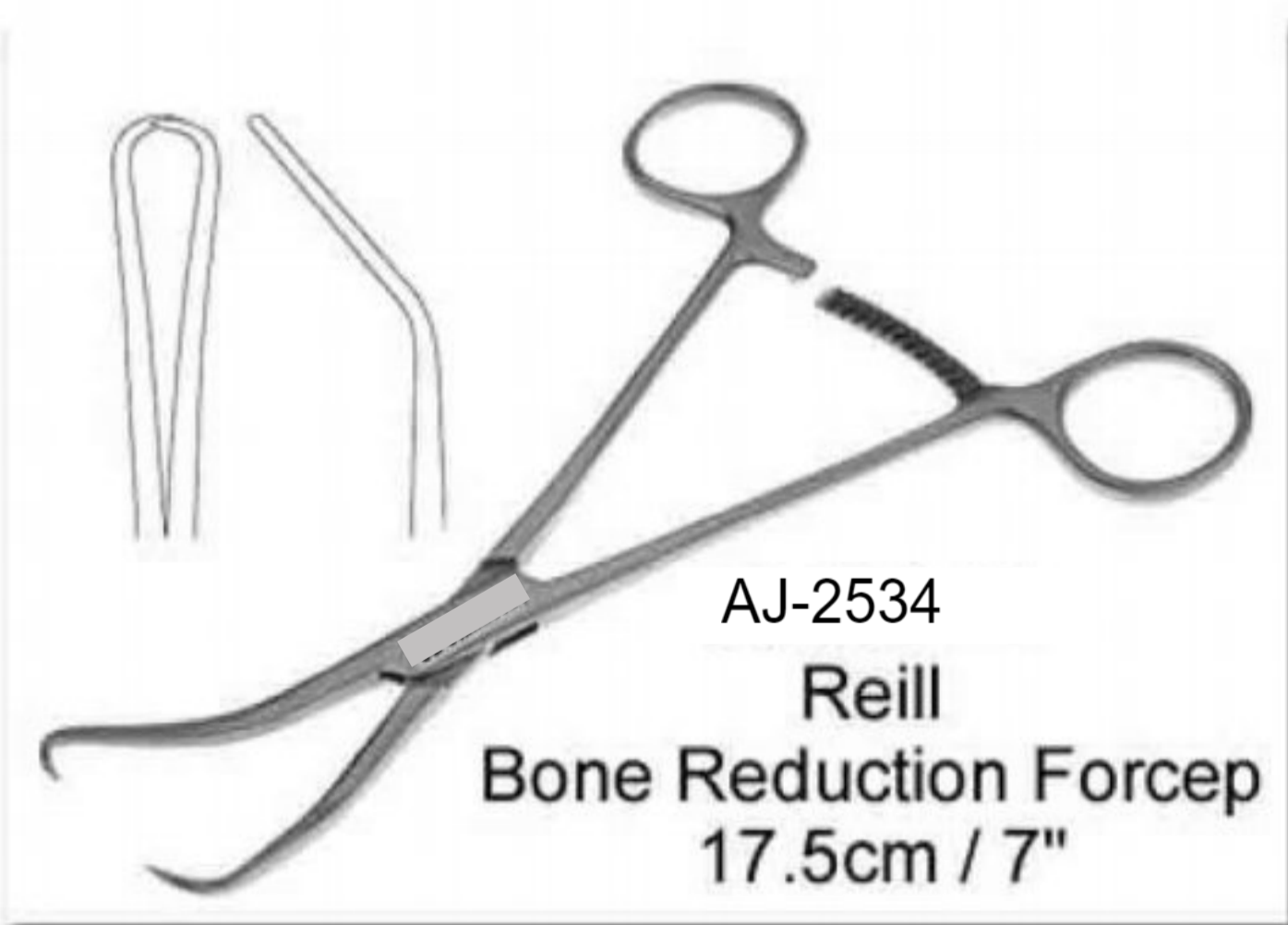

AJ-2534
Reill
Bone Reduction Forcep
17.5cm / 7"

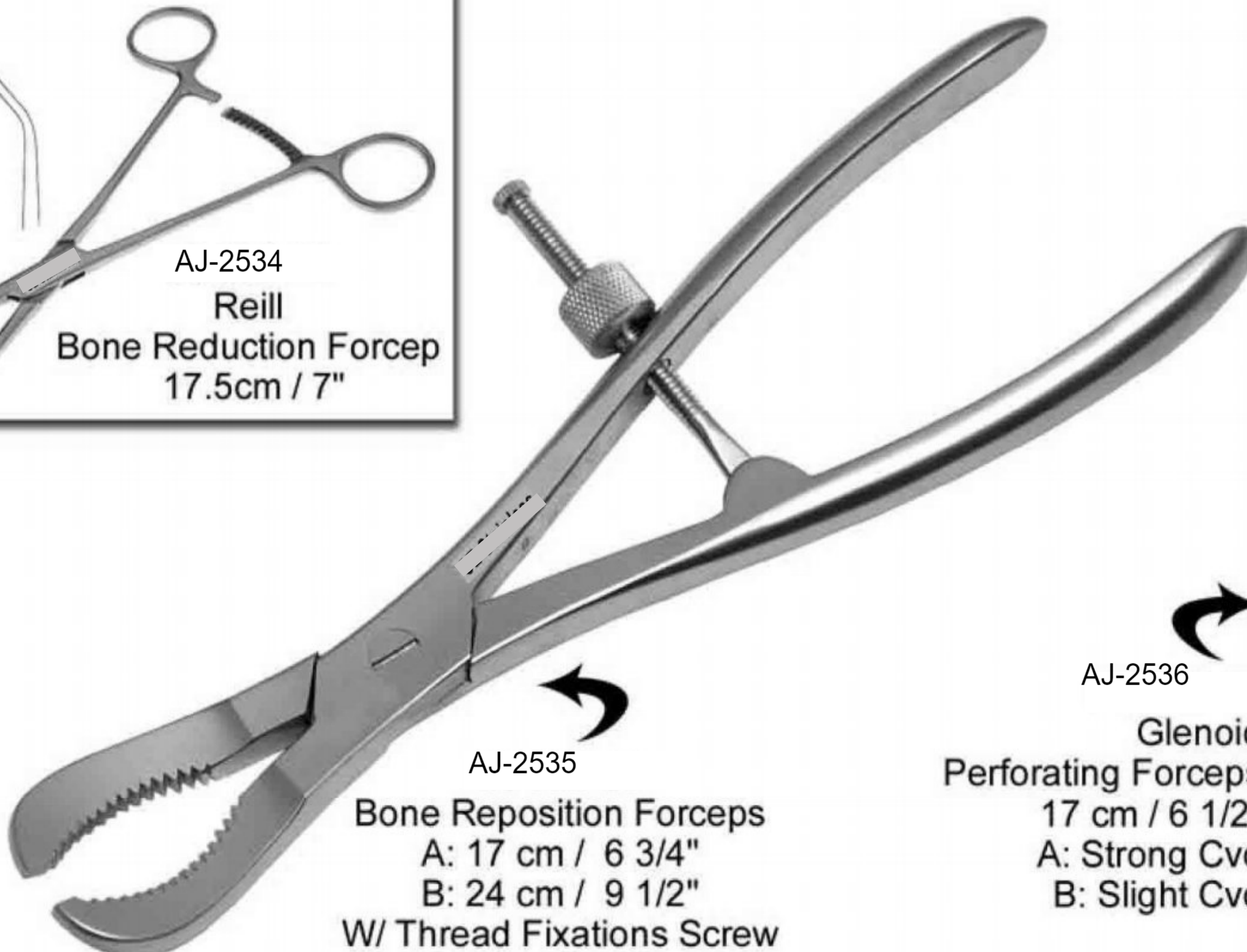

AJ-2535
Bone Reposition Forceps
A: 17 cm / 6 3/4"
B: 24 cm / 9 1/2"
W/ Thread Fixations Screw

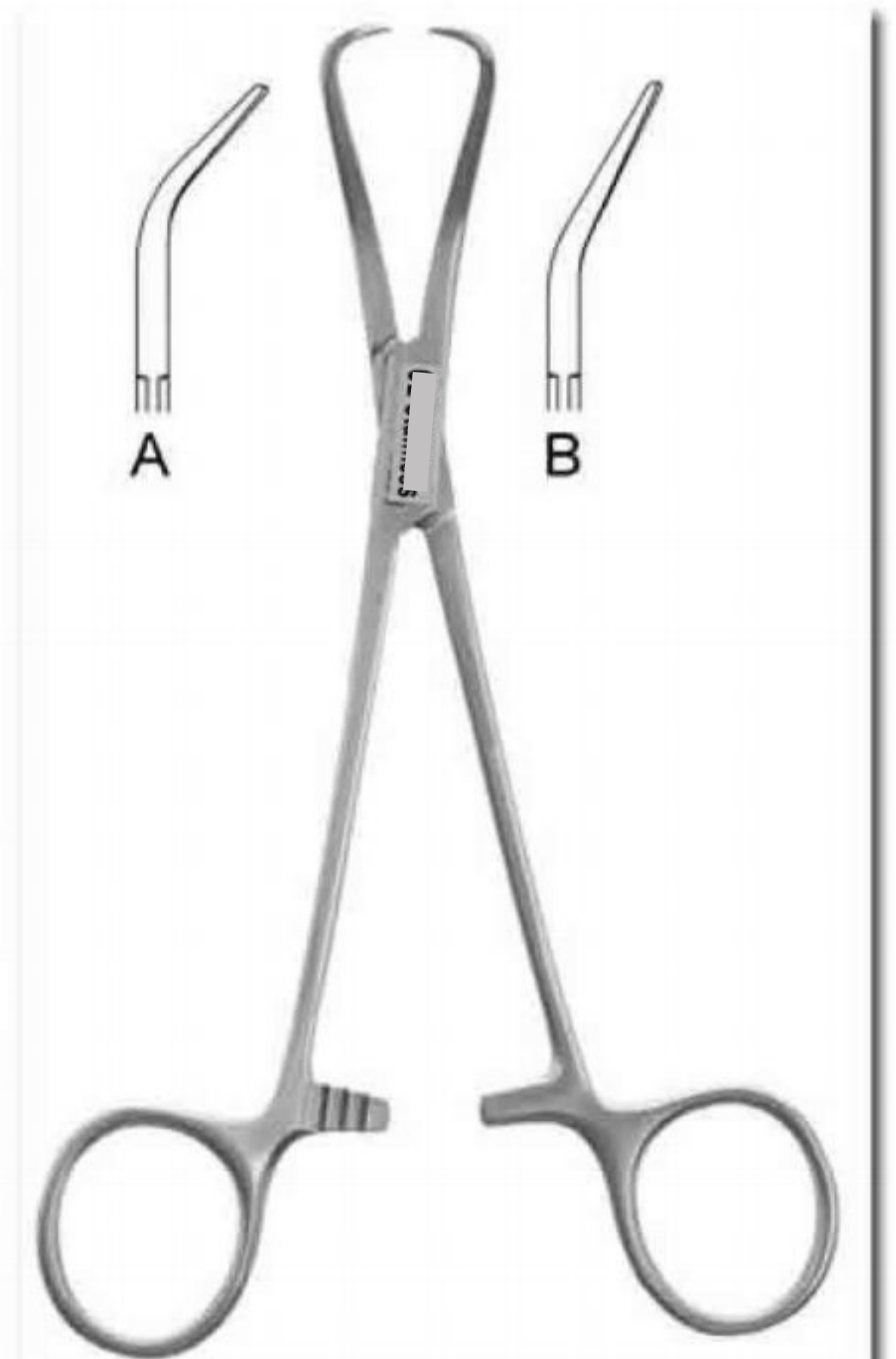

AJ-2536
Glenoid
Perforating Forceps
17 cm / 6 1/2"
A: Strong Cvd
B: Slight Cvd

BONE CUTTING FORCEPS

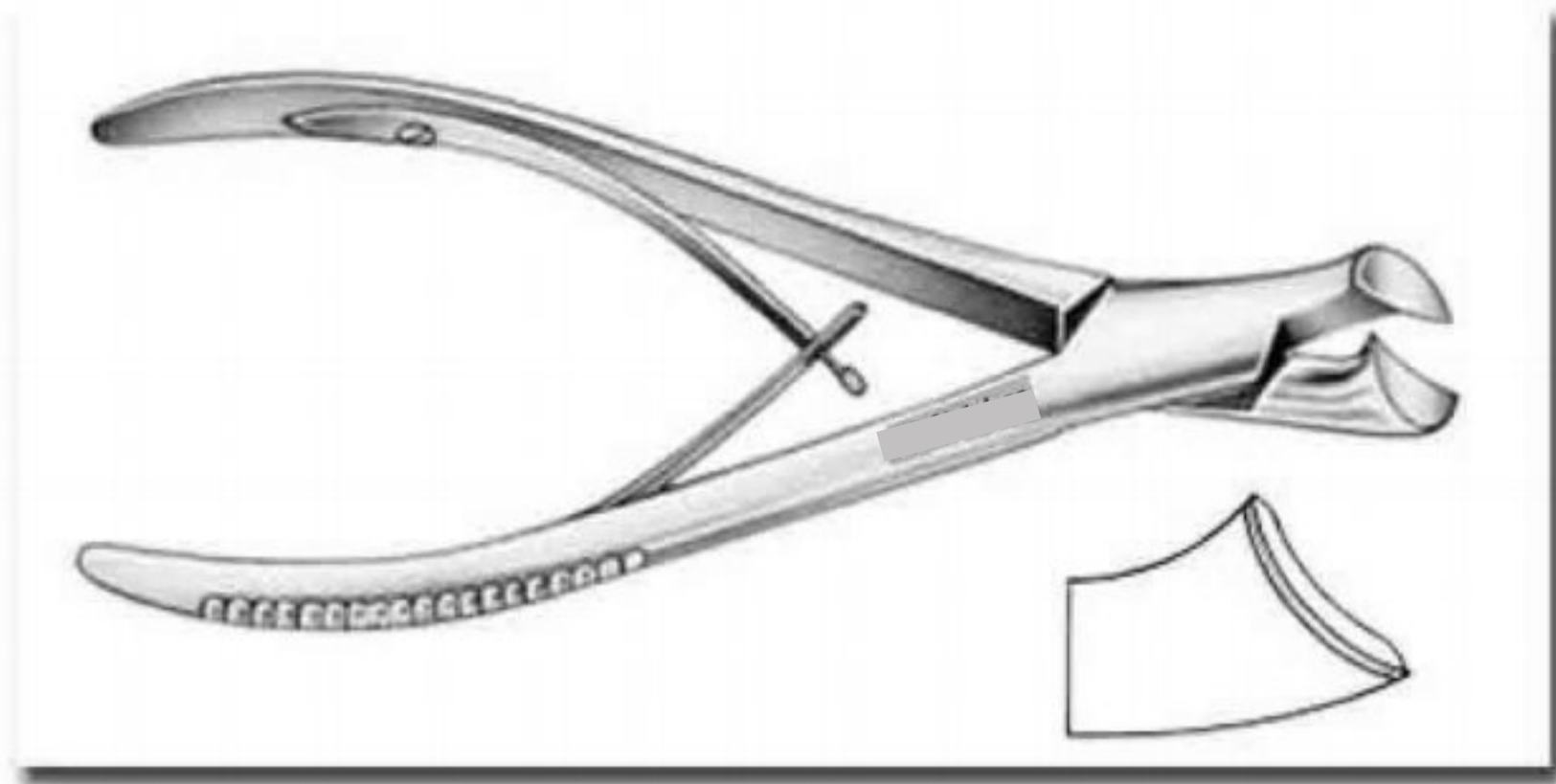

AJ-2537
Marwalder Bone Nipper 18.5 cm / 7 1/4"

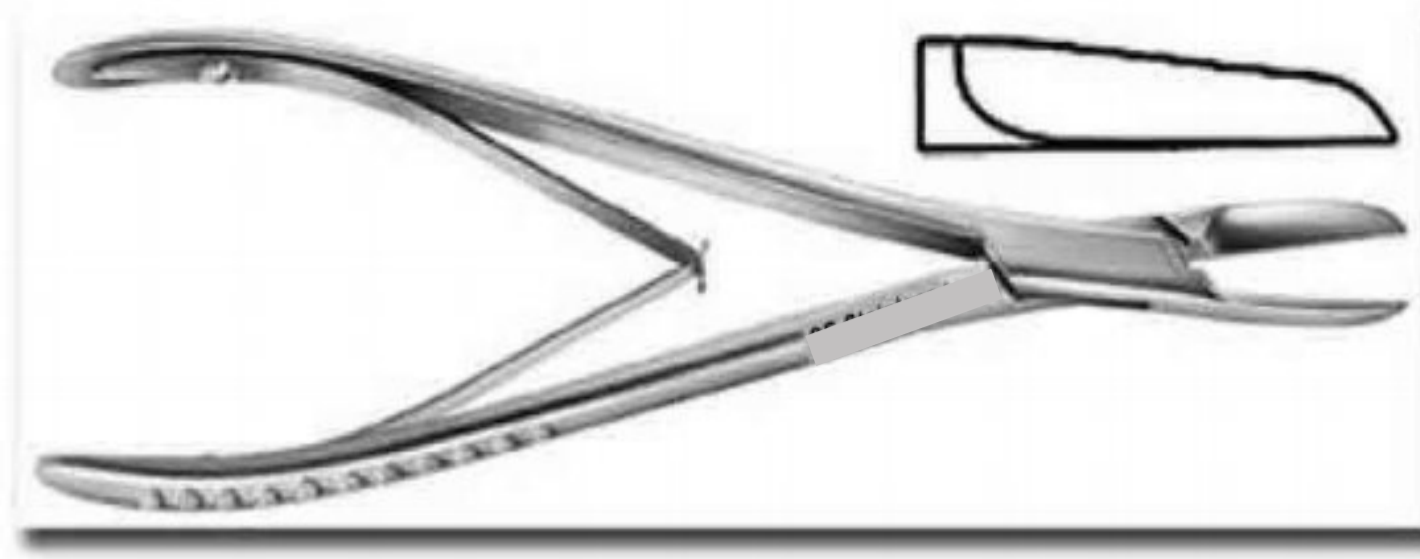

AJ-2537
Cottle Kazanjian Bone Cutting Forceps
18.5 cm / 7 1/4"

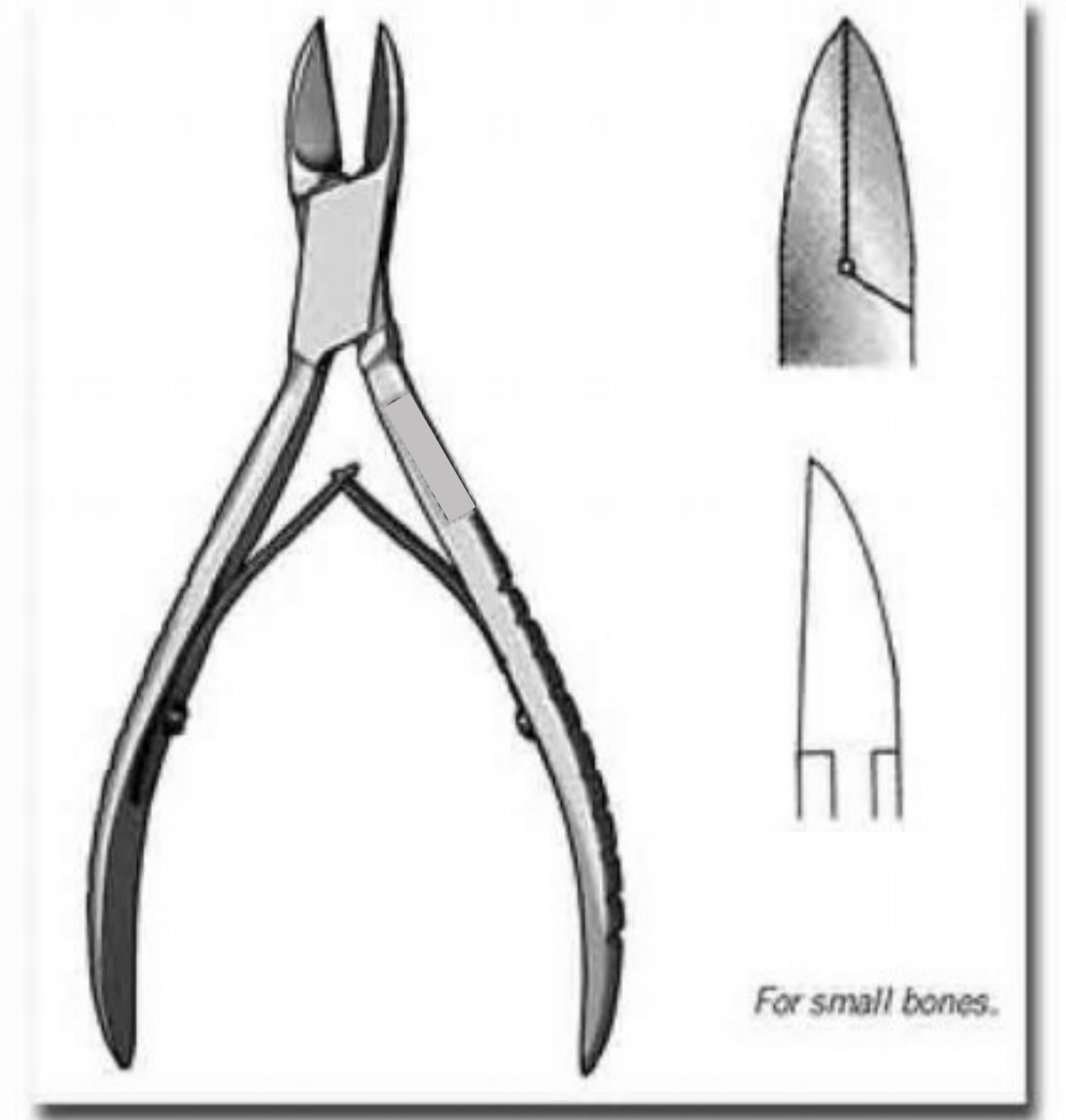

AJ-2538
Littauer Bone Cutting Forceps
15 cm / 6"
For small bones.



AJ-2539
Liston Bone Cutting Forceps

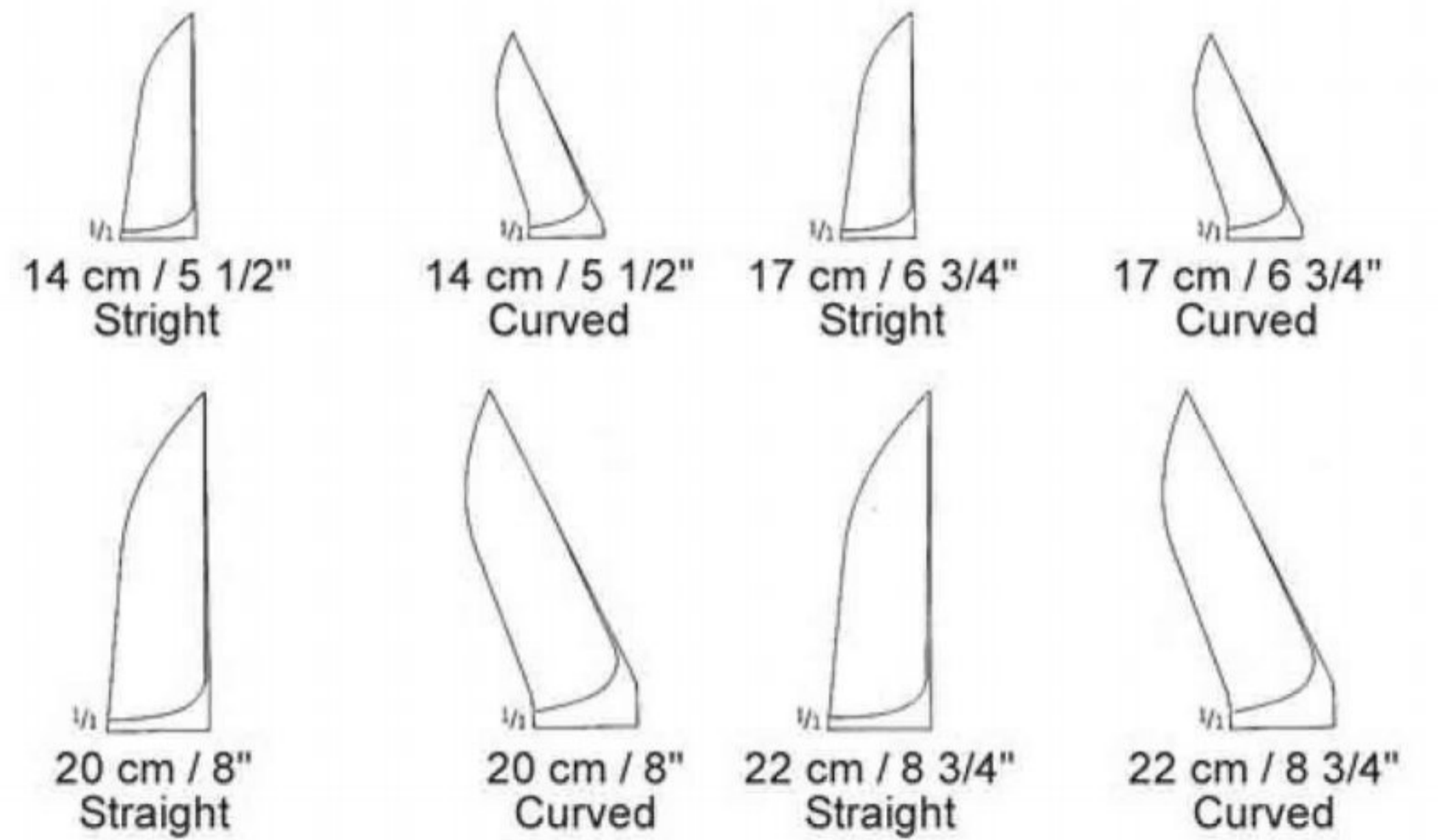

AJ-2540
Cleveland Bone Cutting Forceps
A: 14.5 cm / 5 3/4"
B: 17 cm / 6 3/4"

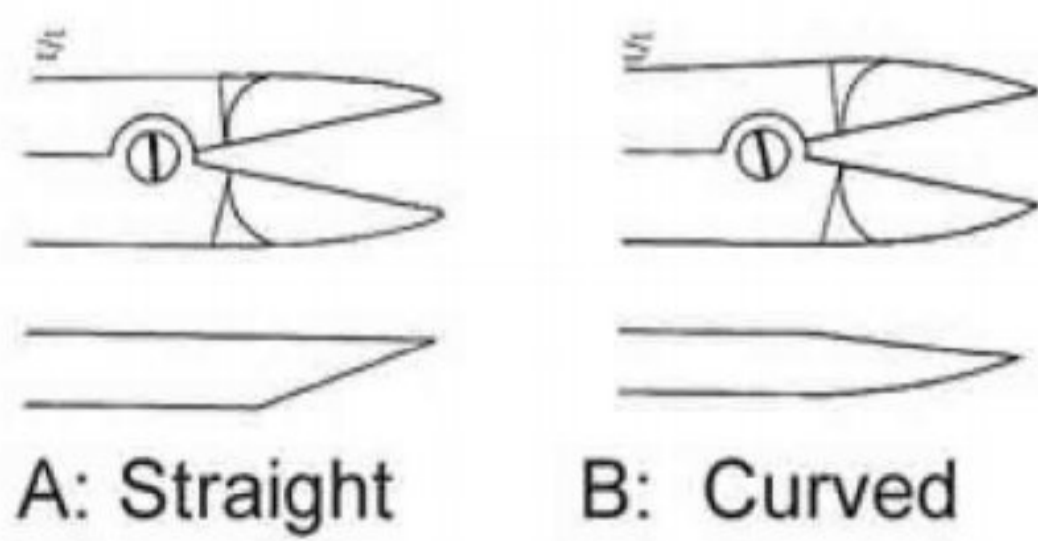
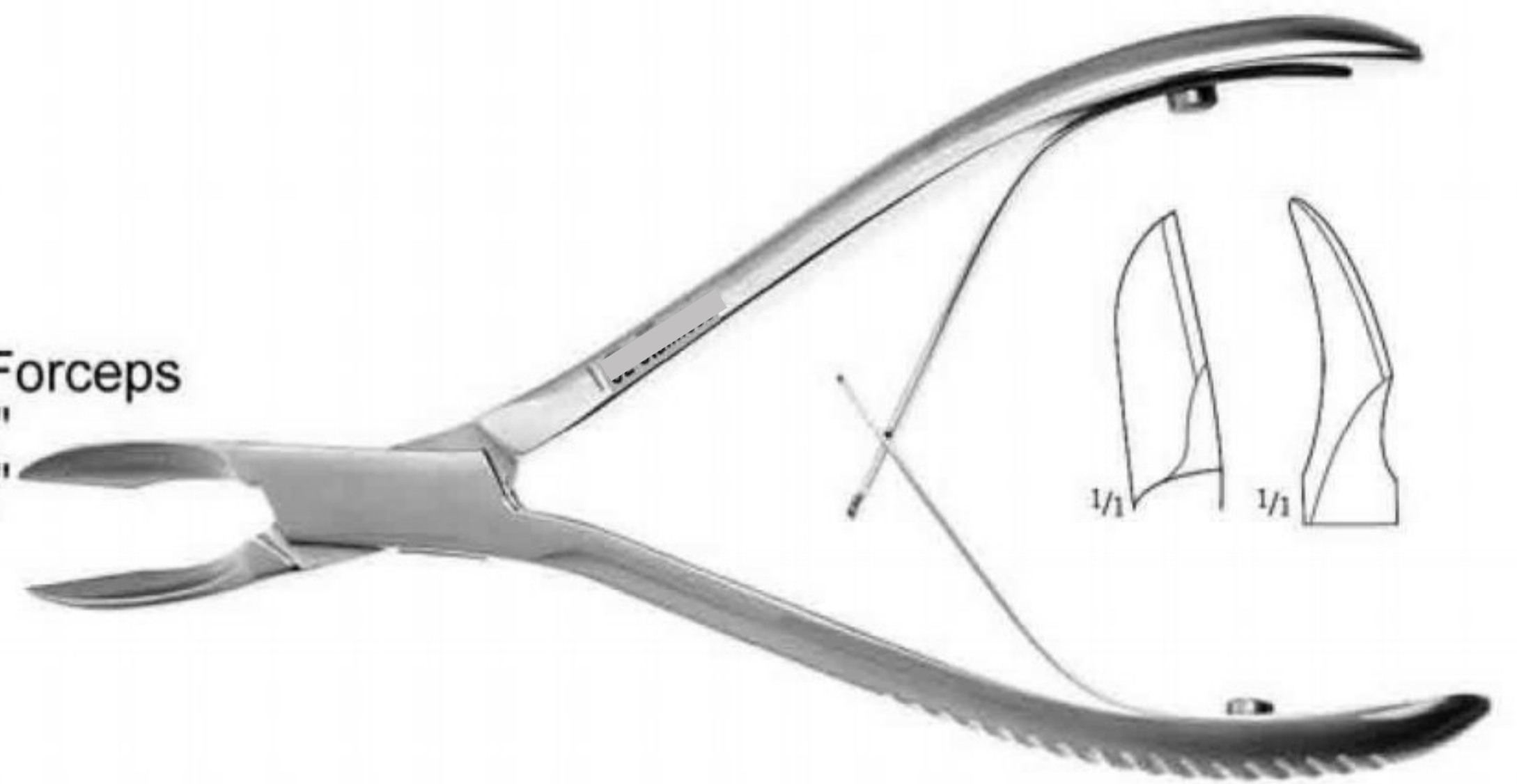

A: Straight B: Curved

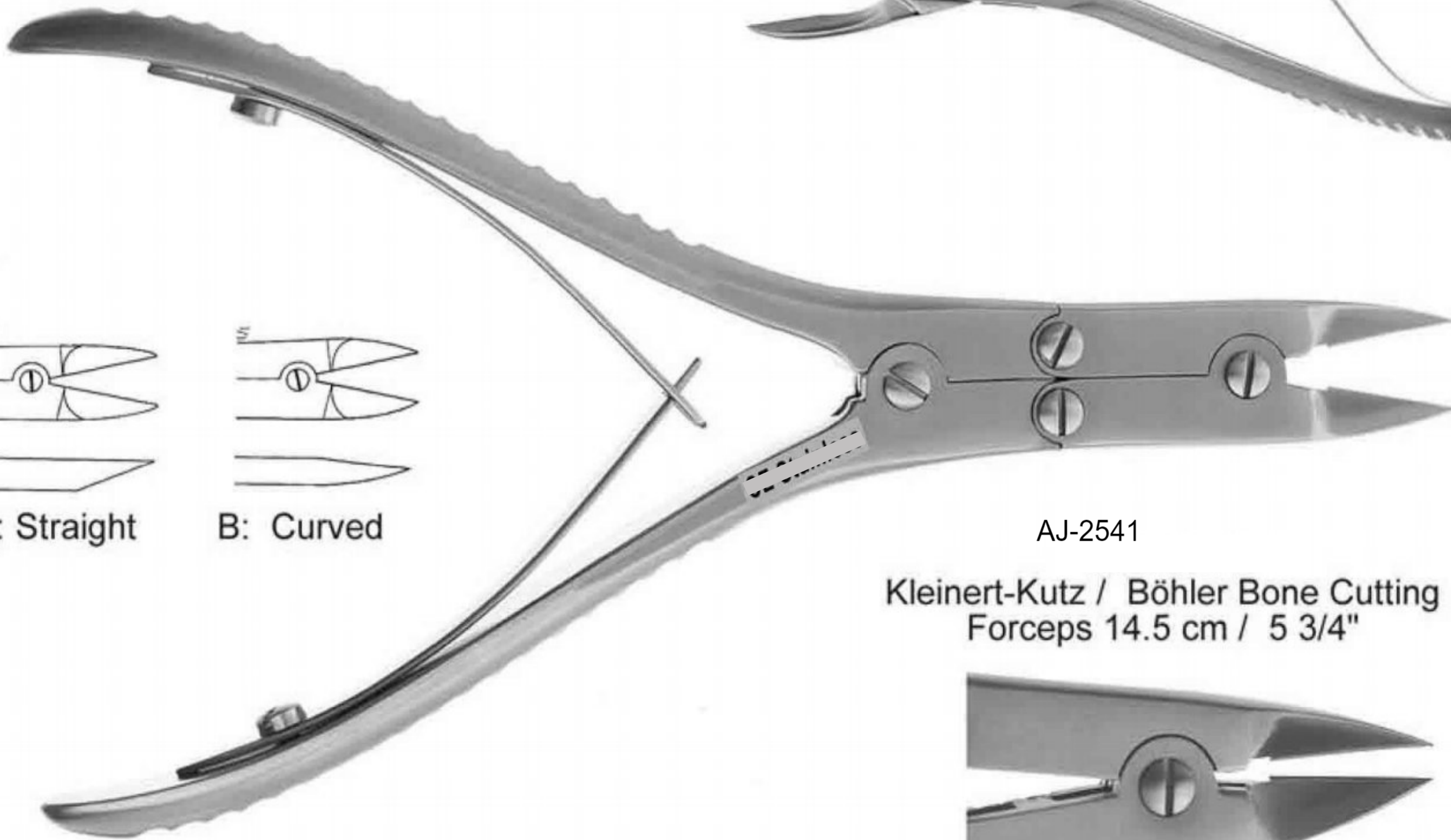

AJ-2541
Kleinert-Kutz / Böhler Bone Cutting
Forceps 14.5 cm / 5 3/4"



BONE CUTTING FORCEPS

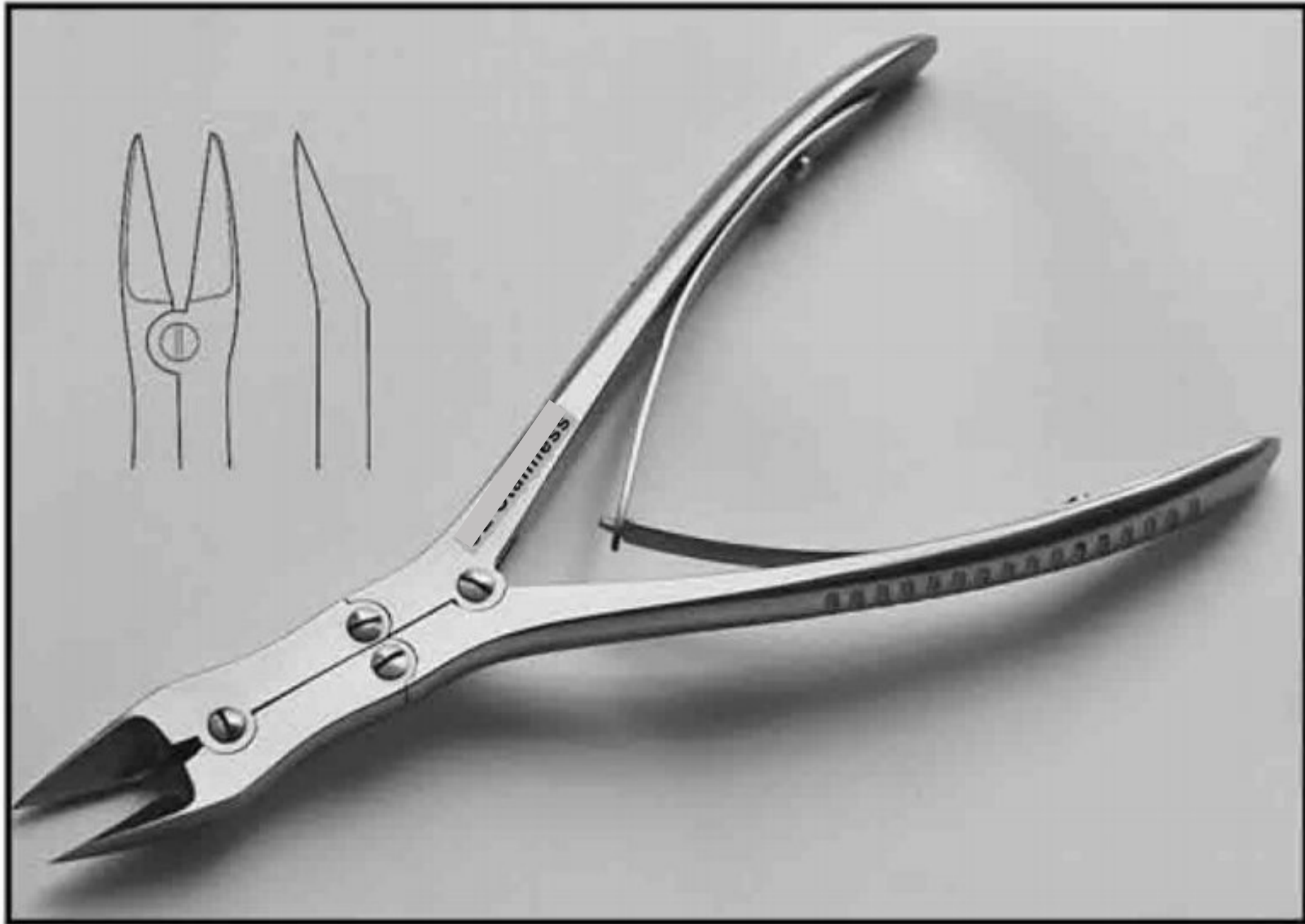

AJ-2542
Mc Indoe
Bone Cutting Forceps
18 cm / 7"
Delicate Blades

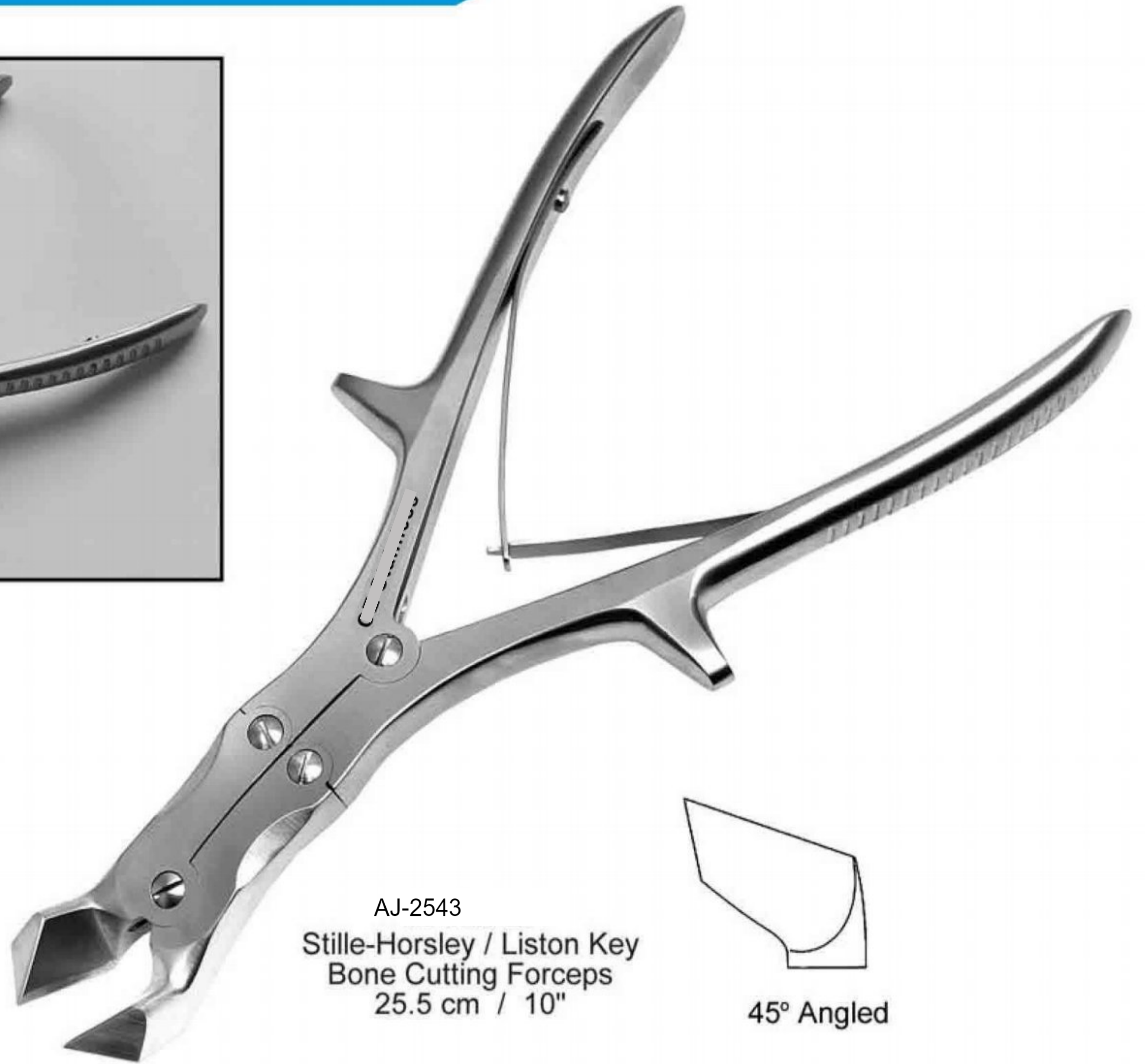

AJ-2543
Stille-Horsley / Liston Key
Bone Cutting Forceps
25.5 cm / 10"

45° Angled

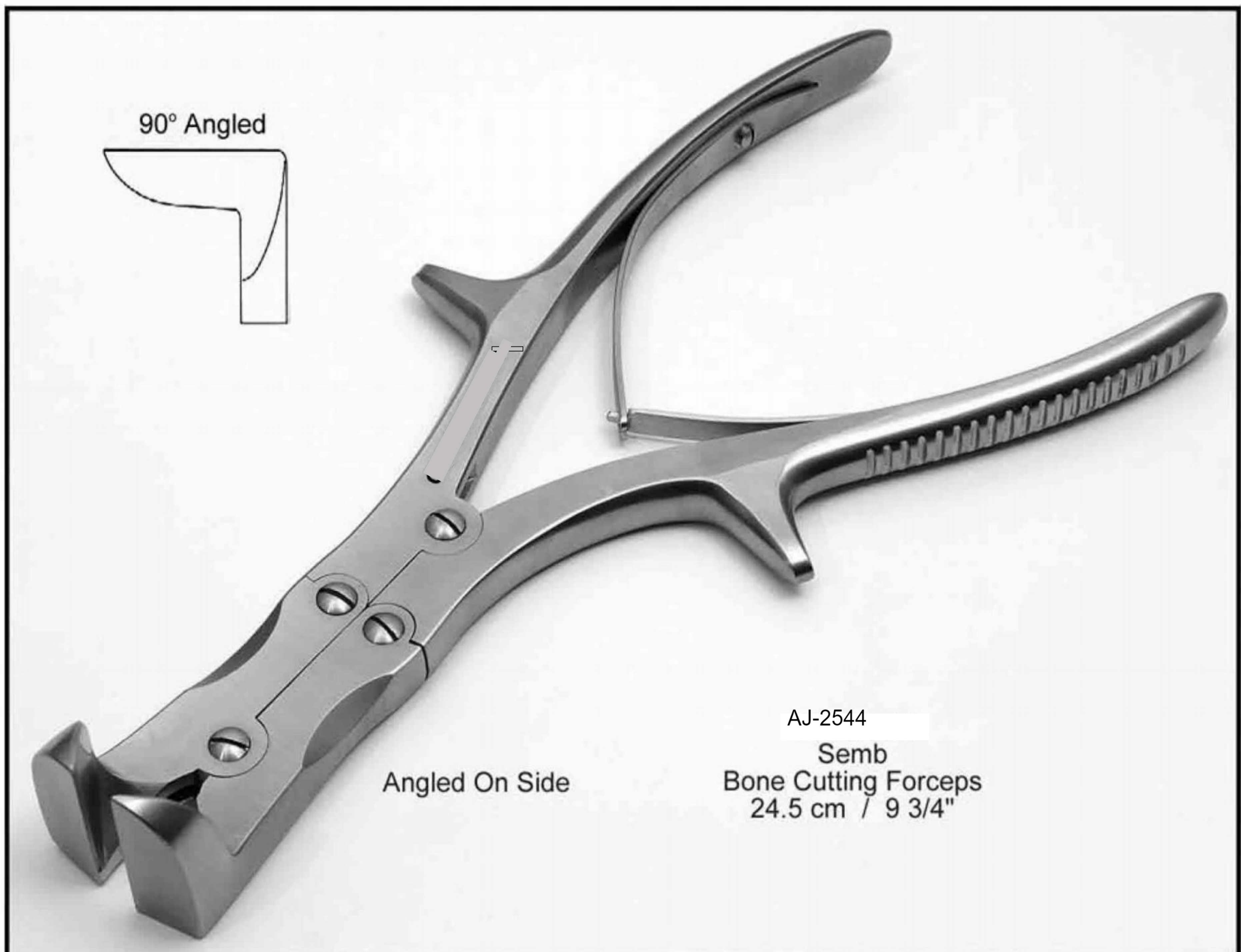

Angled On Side

AJ-2544
Semb
Bone Cutting Forceps
24.5 cm / 9 3/4"

90° Angled

BONE RONGEURS - NIBBLERS

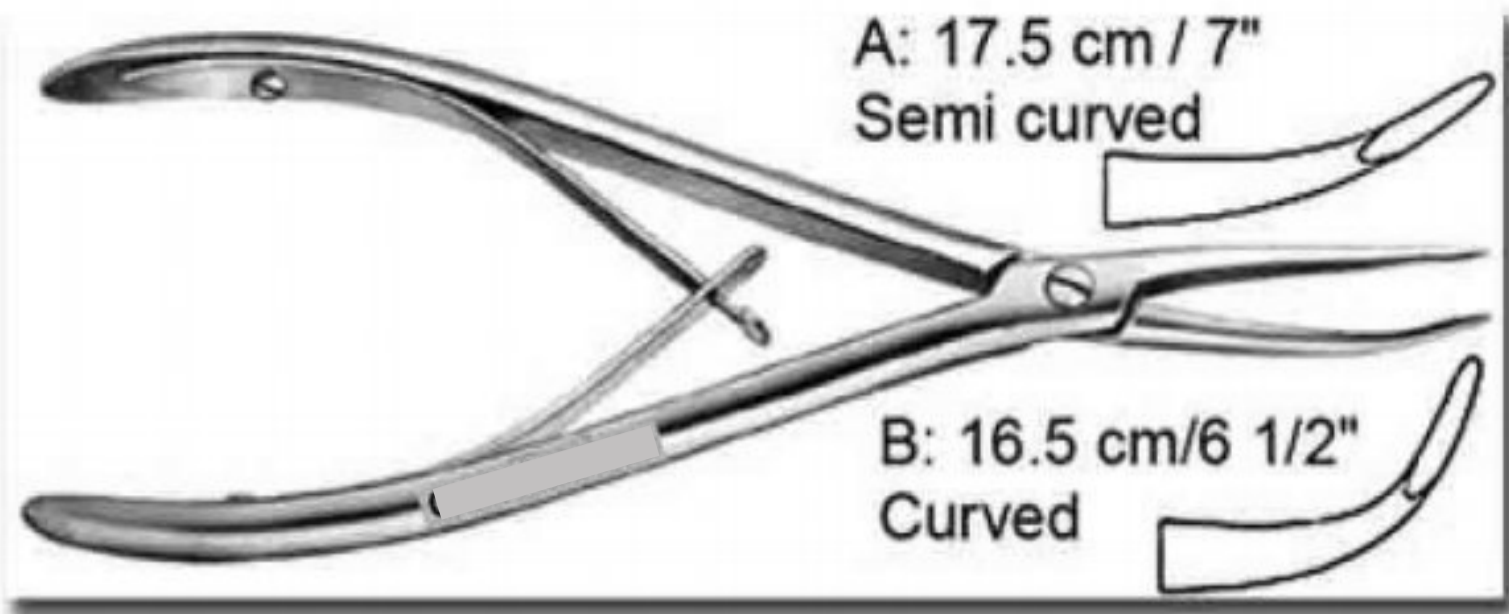

A: 17.5 cm / 7"
Semi curved
B: 16.5 cm / 6 1/2"
Curved

AJ-2545 Stellbrink Bone Rongeur

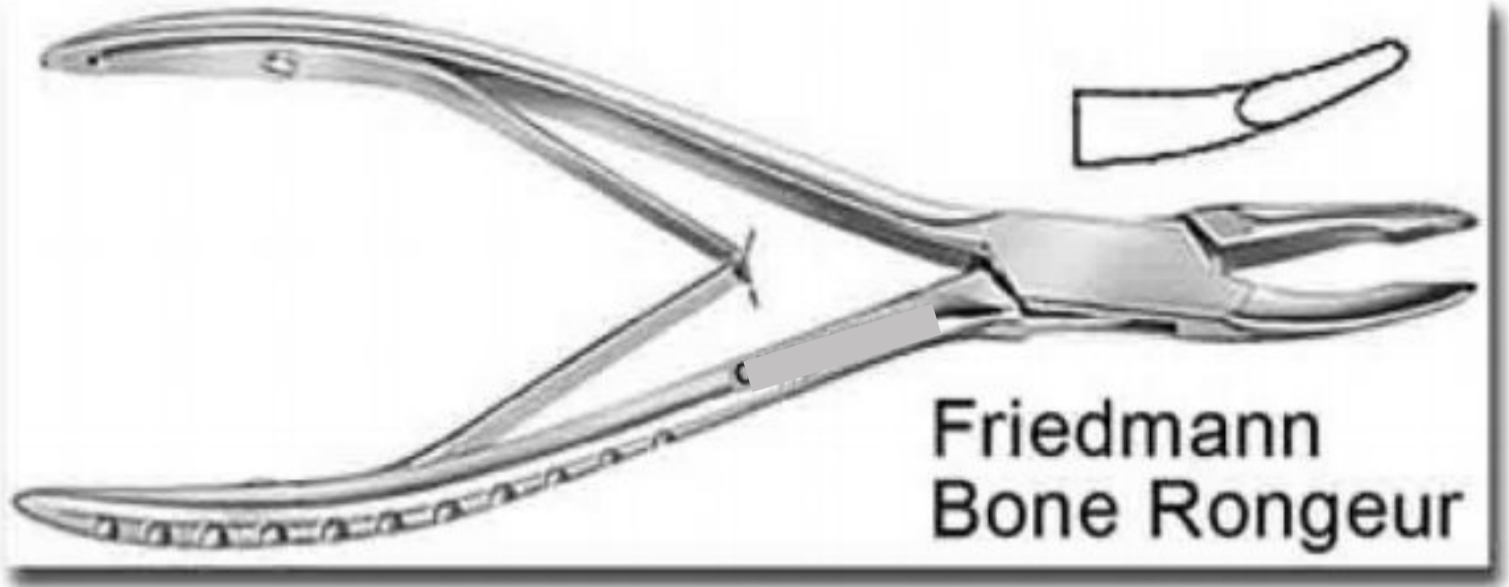

AJ-2547 A: 12.5cm / 5"
B: 13.5cm / 5 1/4"

Friedmann Bone Rongeur



AJ-2549 13.5 cm / 5 1/4"

Friedmann Bone Rongeur

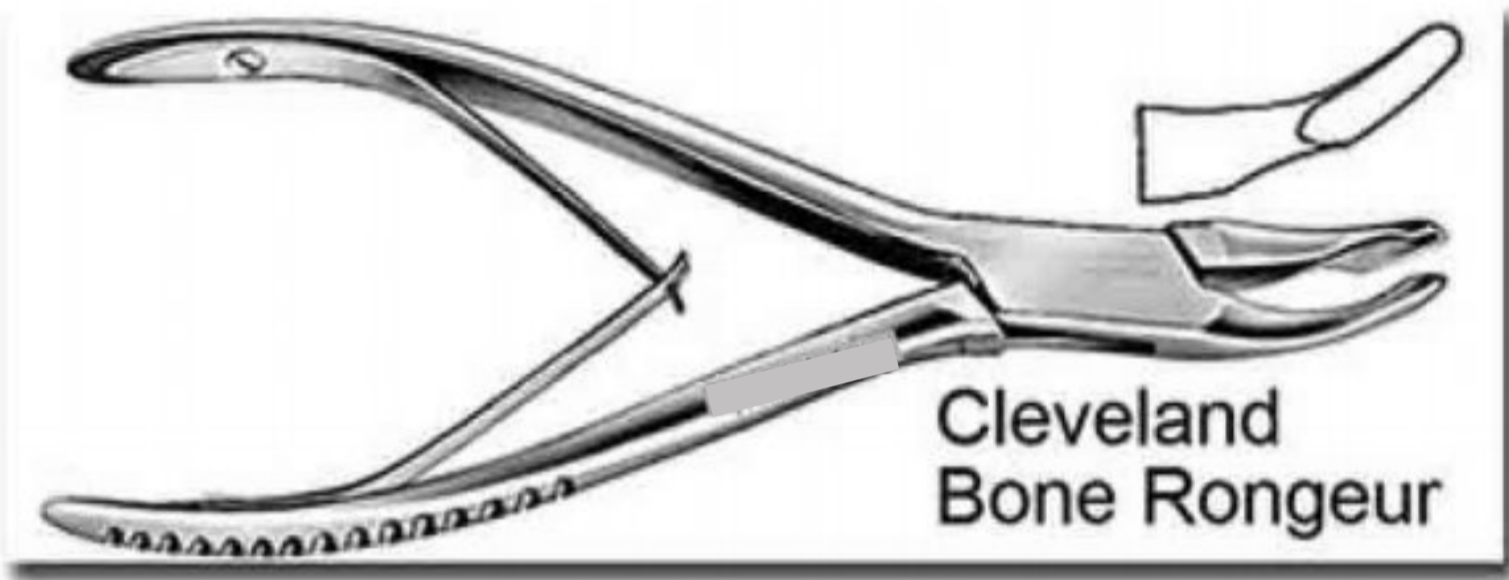

AJ-2552 A: 13.5 cm / 5 1/4" B: 16.5 cm / 6 1/2"

Cleveland Bone Rongeur



AJ-2553 Mead Bone Rongeur
16.5 cm / 6 1/2"

Mead Bone Rongeur

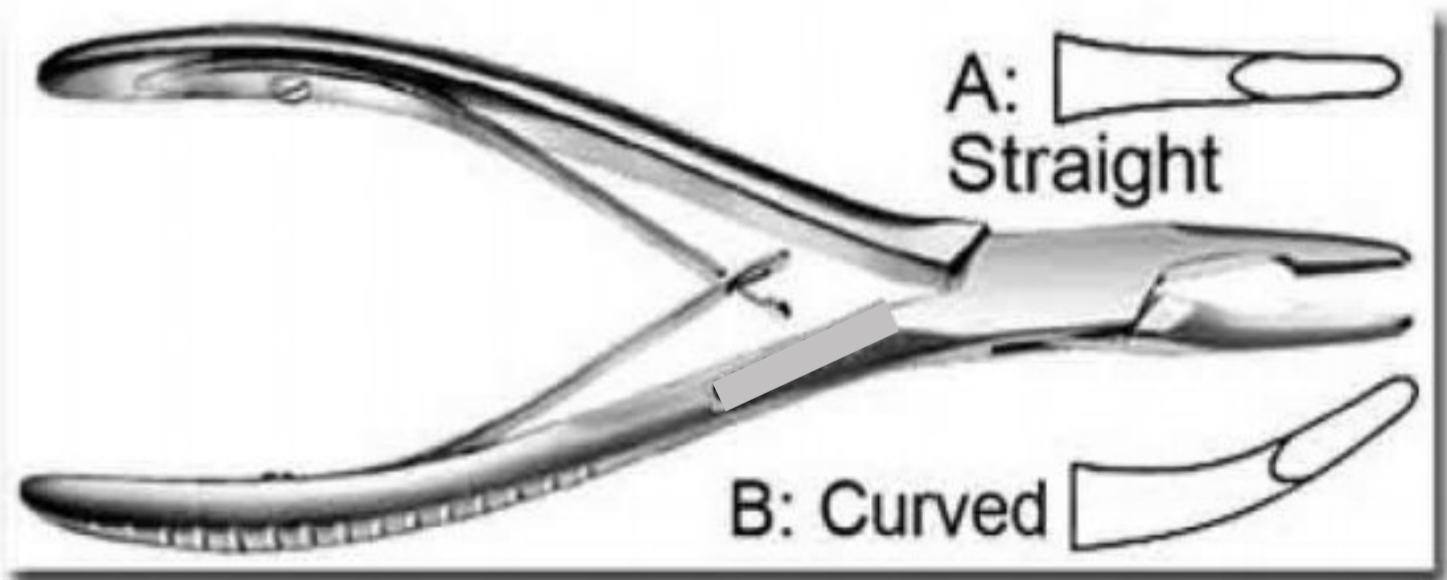

AJ-2555 Jansen Bone Rongeur
18 cm / 7"

A: Straight

B: Curved

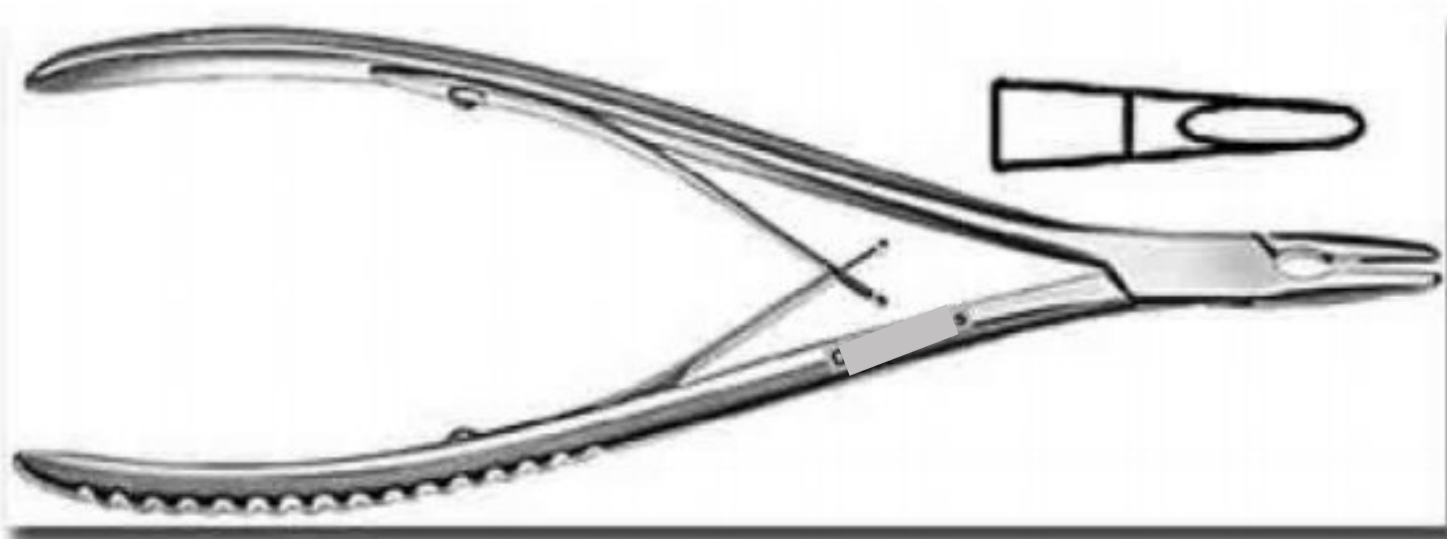

AJ-2556 Lempert Bone Rongeur
19 cm / 7 1/2"

Lempert Bone Rongeur

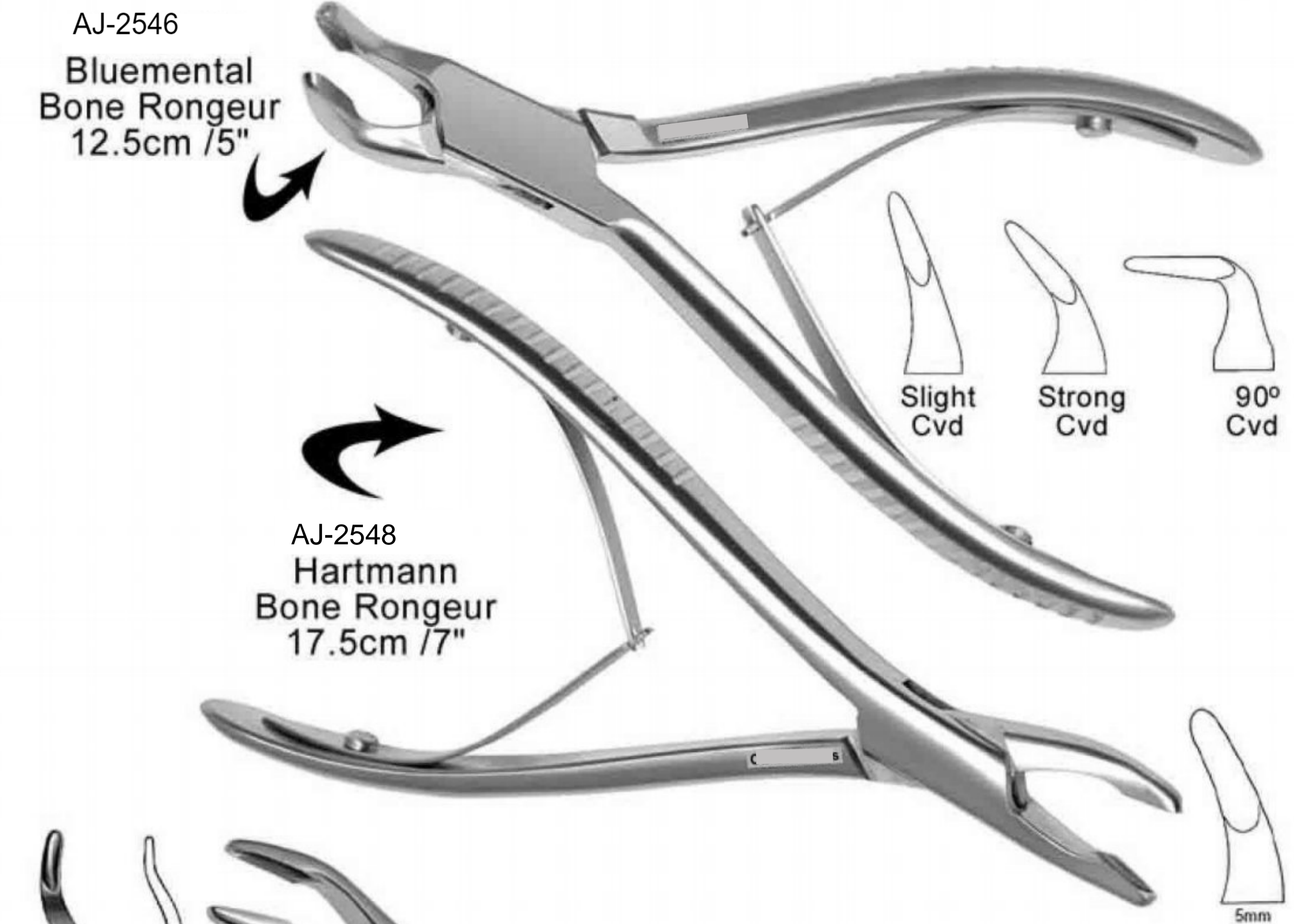

AJ-2546
Bluemental Bone Rongeur
12.5cm / 5"



AJ-2548
Hartmann Bone Rongeur
17.5cm / 7"



Slight Cvd Strong Cvd 90° Cvd



4mm



5mm

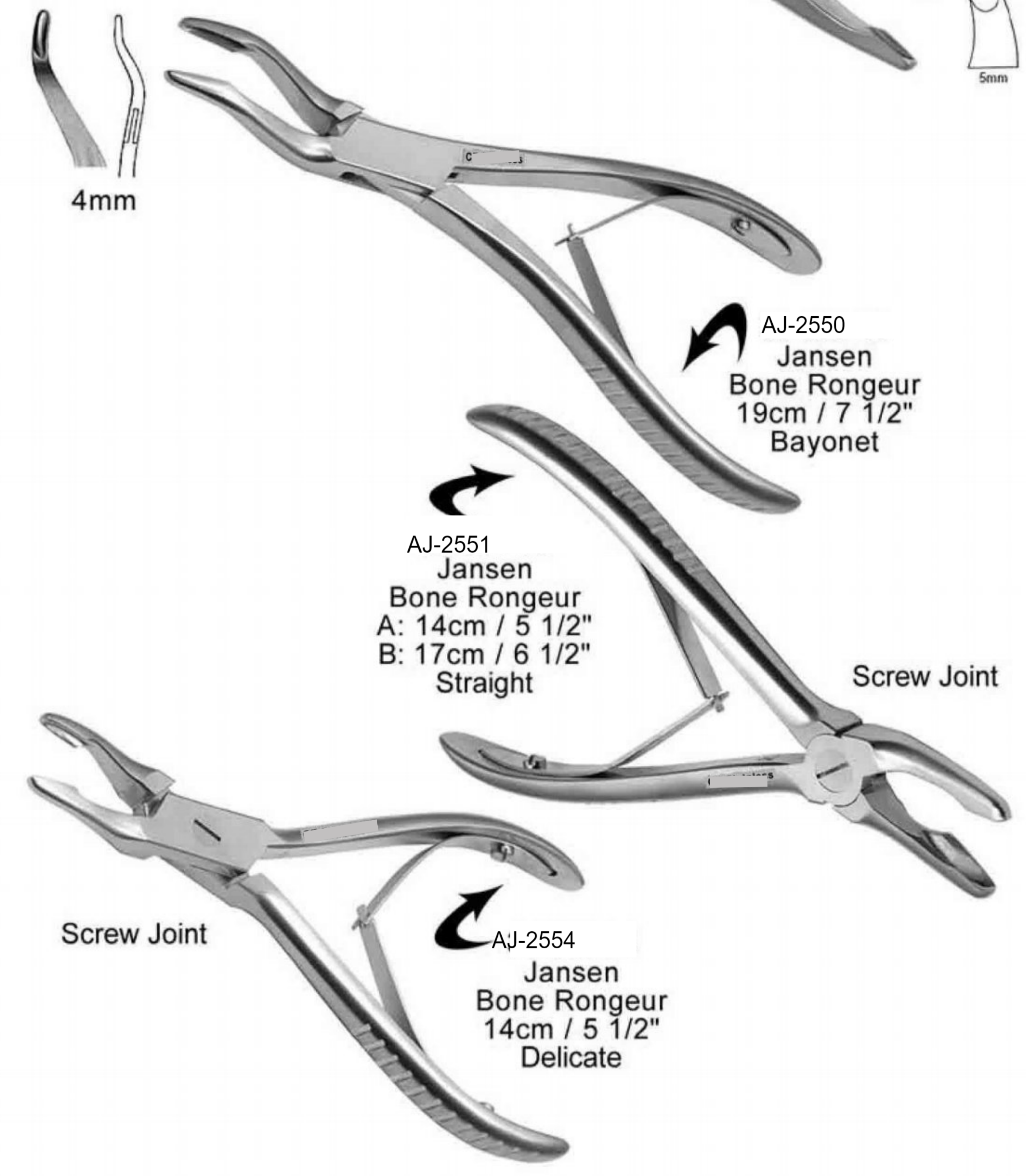

AJ-2550
Jansen Bone Rongeur
19cm / 7 1/2"
Bayonet



AJ-2551
Jansen Bone Rongeur
A: 14cm / 5 1/2"
B: 17cm / 6 1/2"
Straight



Screw Joint

Screw Joint

AJ-2554
Jansen Bone Rongeur
14cm / 5 1/2"
Delicate

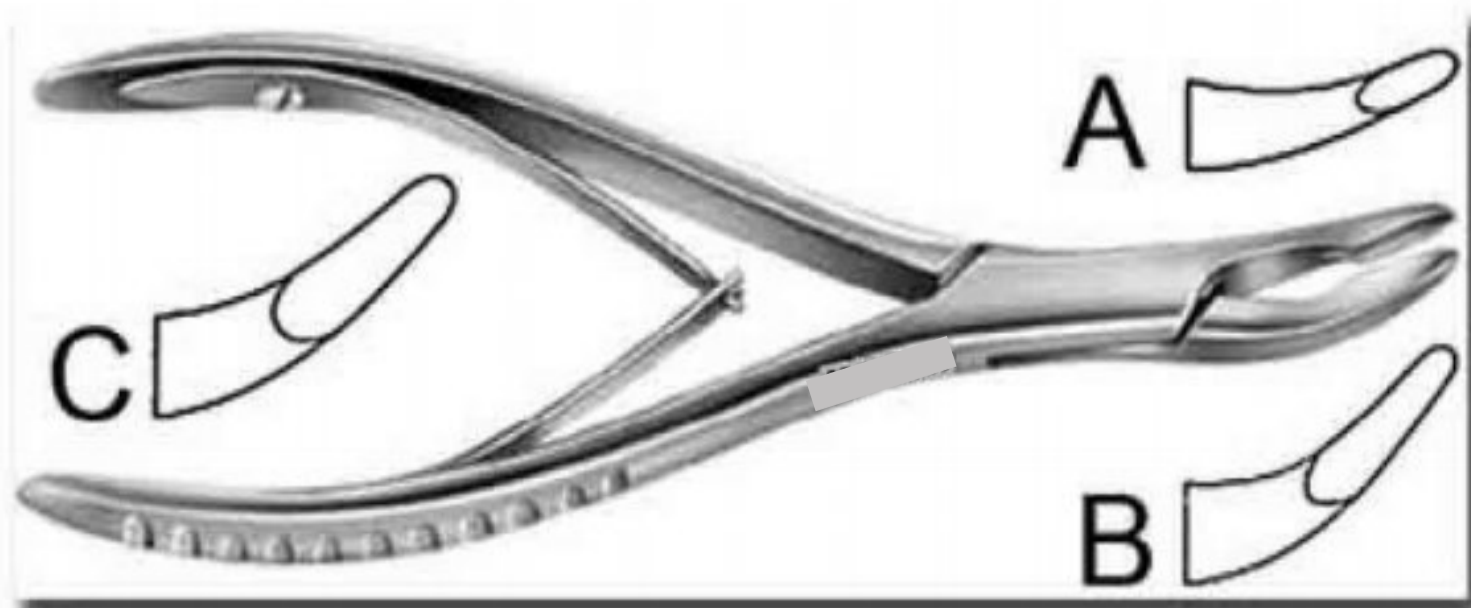

AJ-2557 Luer Bone Rongeur
14.5 cm / 5 3/4"

A B C

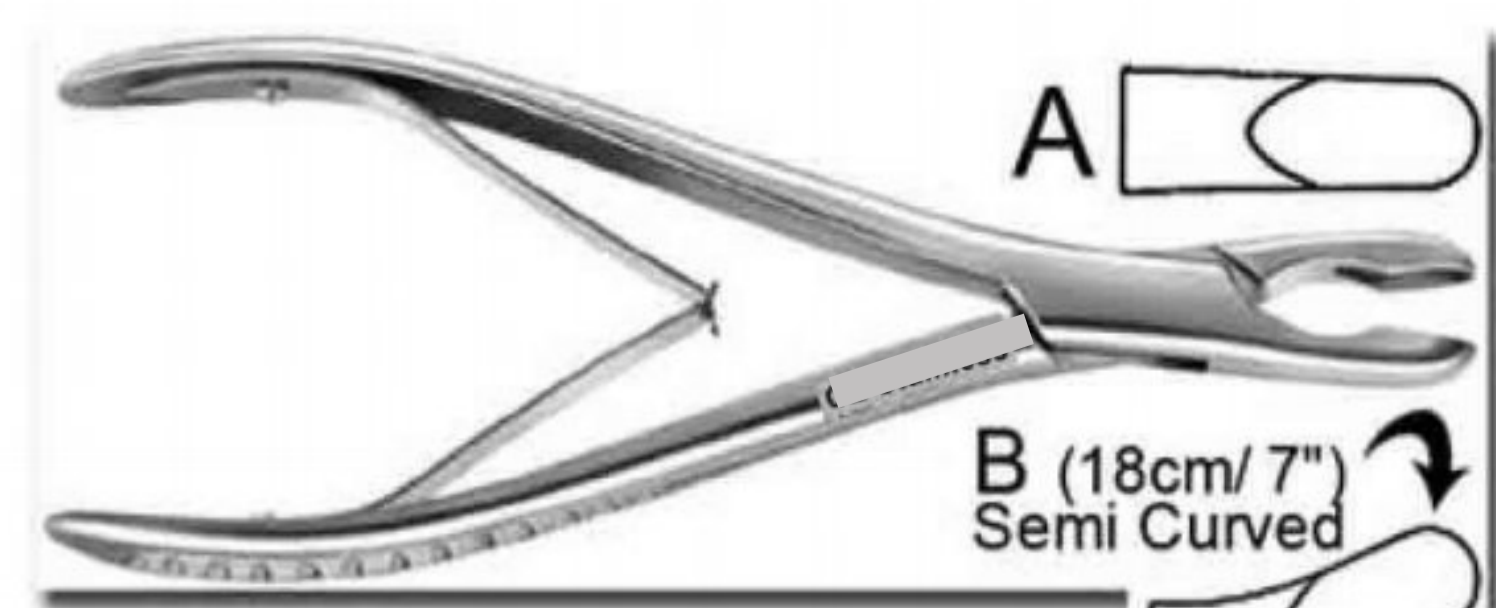

AJ-2558 Luer Bone Rongeur
18.5 cm / 7 1/4"

A B (18cm / 7") Semi Curved

BONE RONGEURS - NIBBLERS

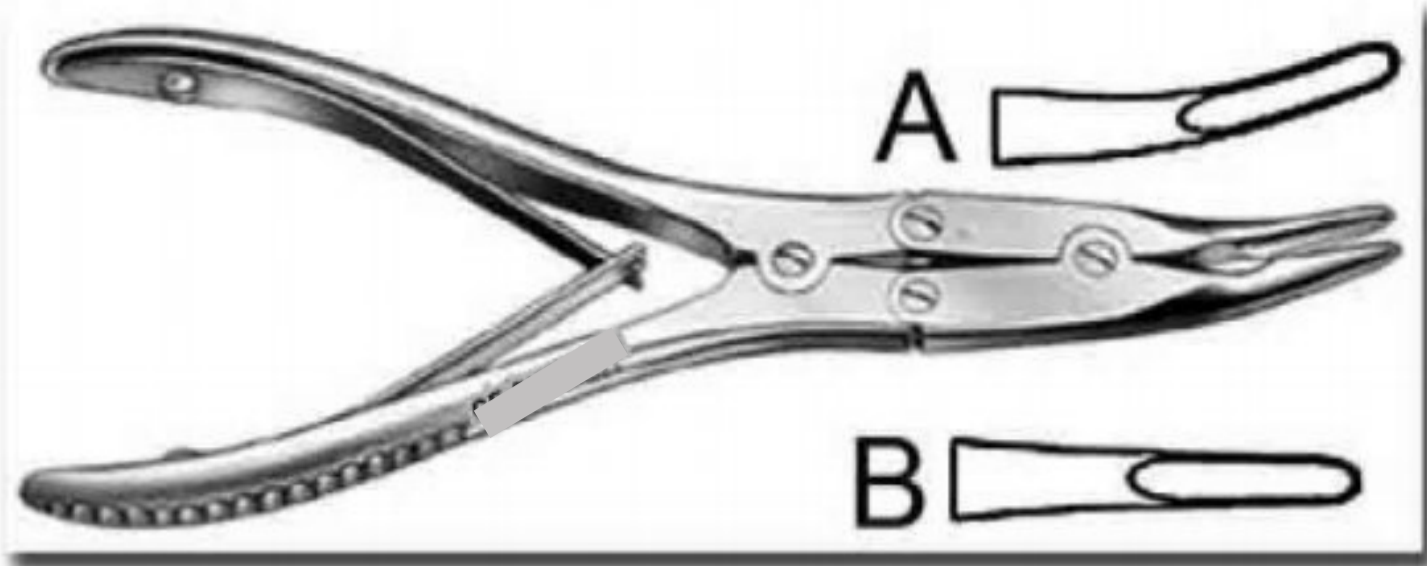

AJ-2559 Böhler Bone Rongeur
15.5 cm / 6"



AJ-2561 Beyer Bone Rongeur
18 cm / 7"



AJ-2562 Zaufal-Jansen
Bone Rongeur 18 cm / 7"



AJ-2563
Mayfield Bone Rongeur
18 cm / 7"



AJ-2565 Marquard
Bone Rongeur 20.5 cm / 8"



AJ-2560
Stille Bone Rongeur
22.5 cm / 8 3/4"

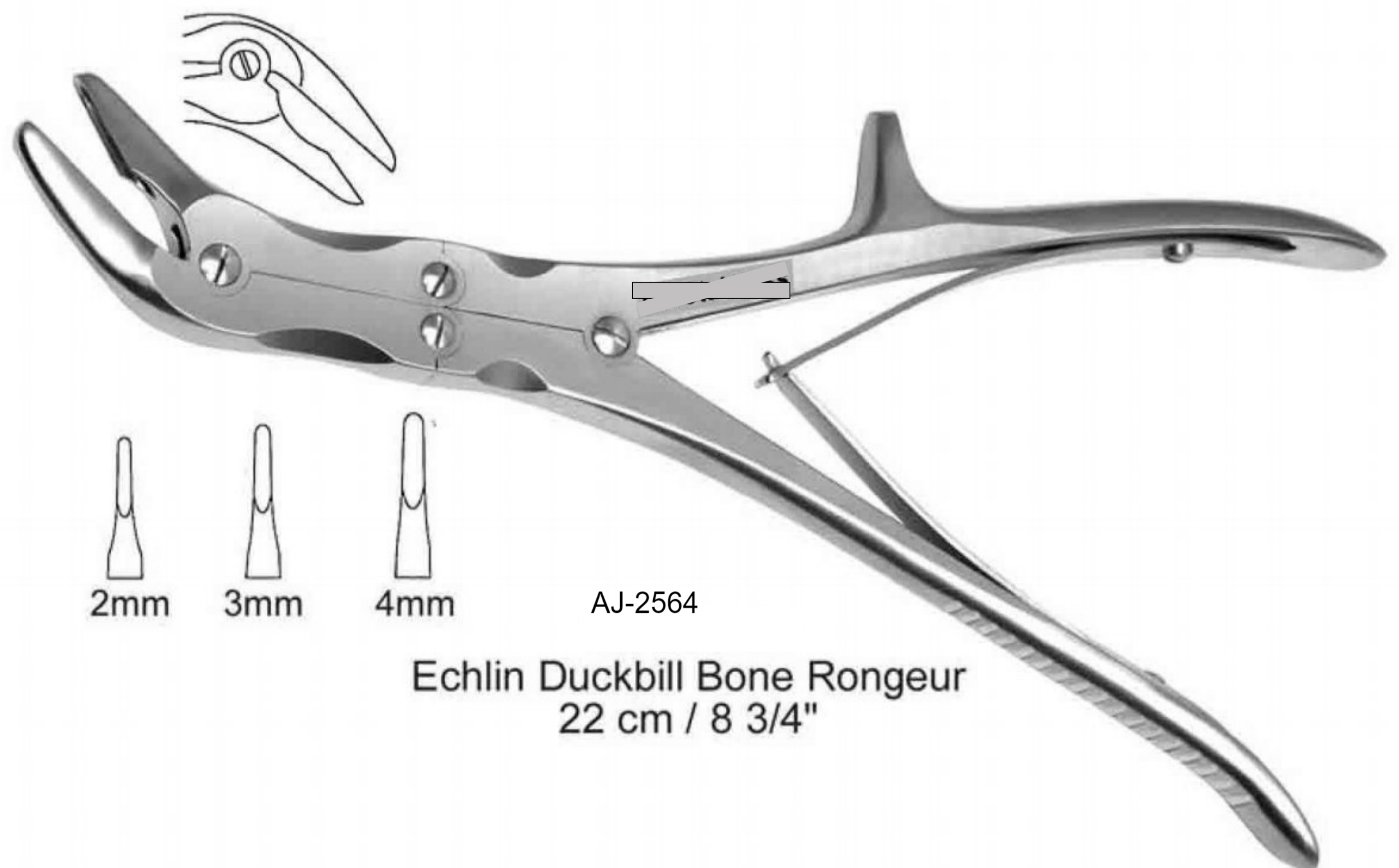

2mm 3mm 4mm

AJ-2564

Echlin Duckbill Bone Rongeur
22 cm / 8 3/4"

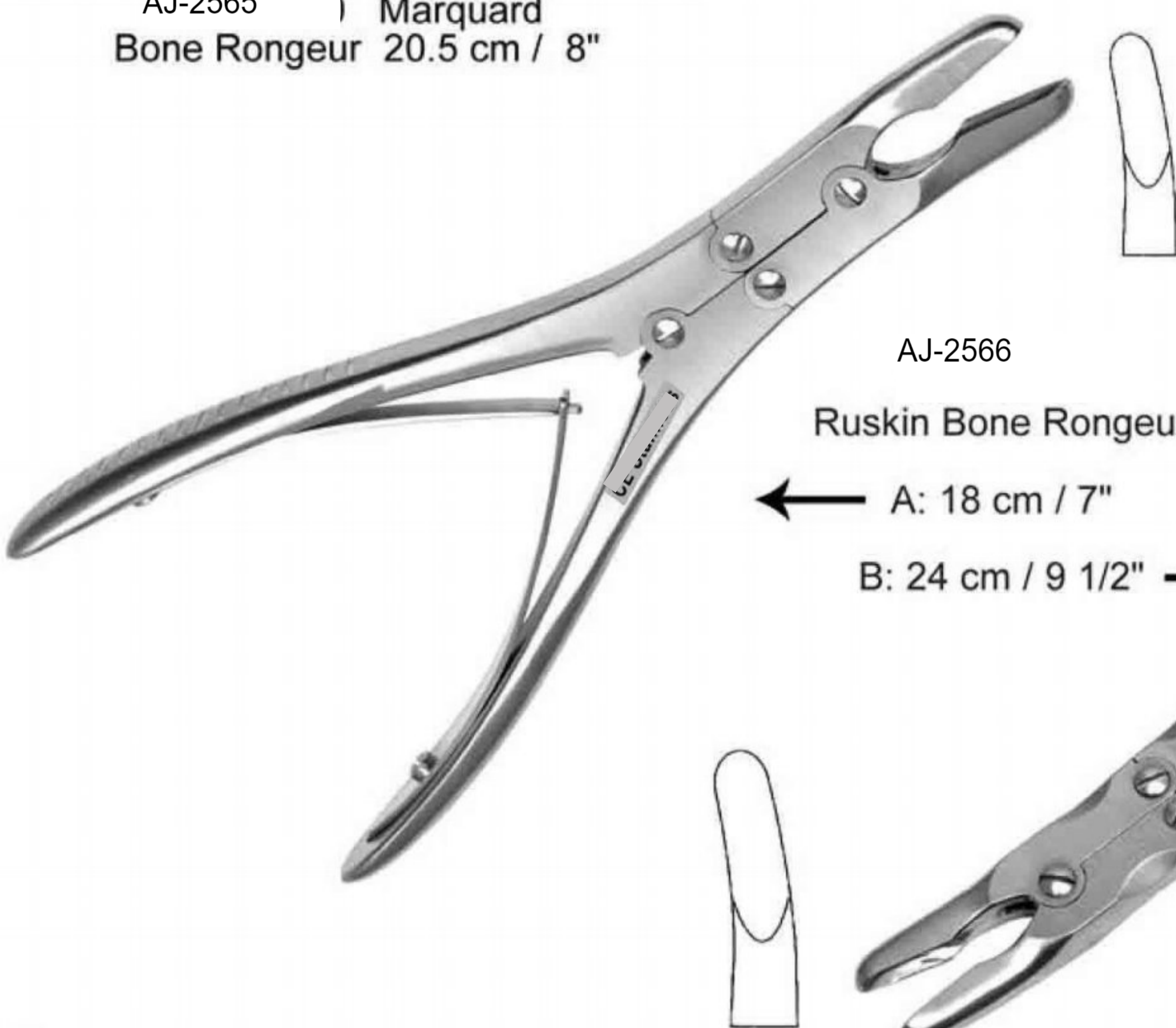

AJ-2566
Ruskin Bone Rongeur
← A: 18 cm / 7"
B: 24 cm / 9 1/2" →

BONE RONGEURS - NIBBLERS

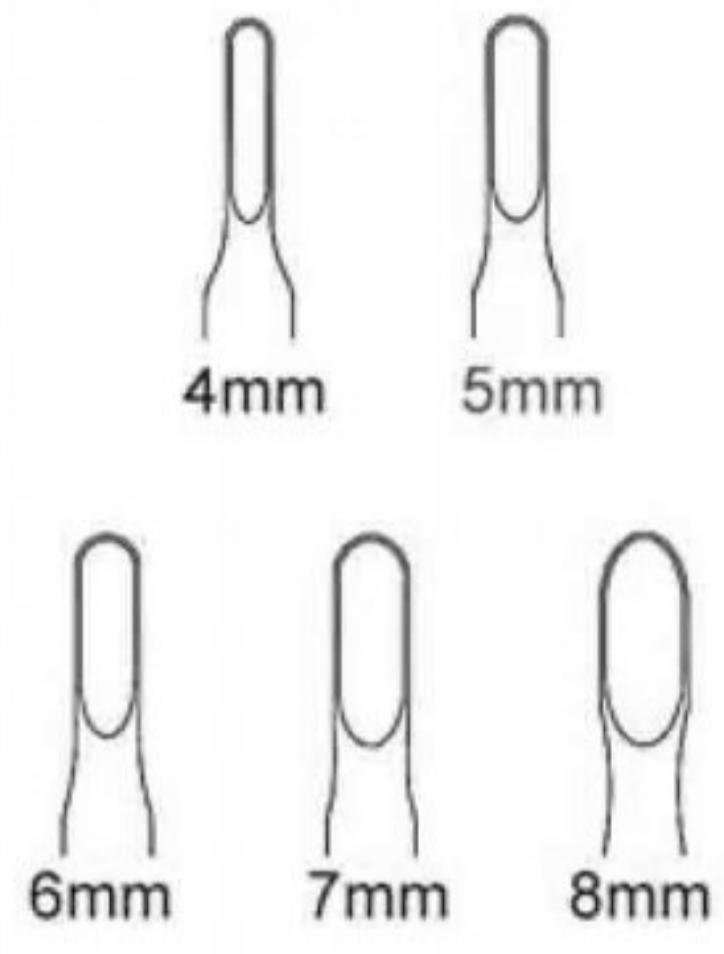

Same Size In Both Rongeurs

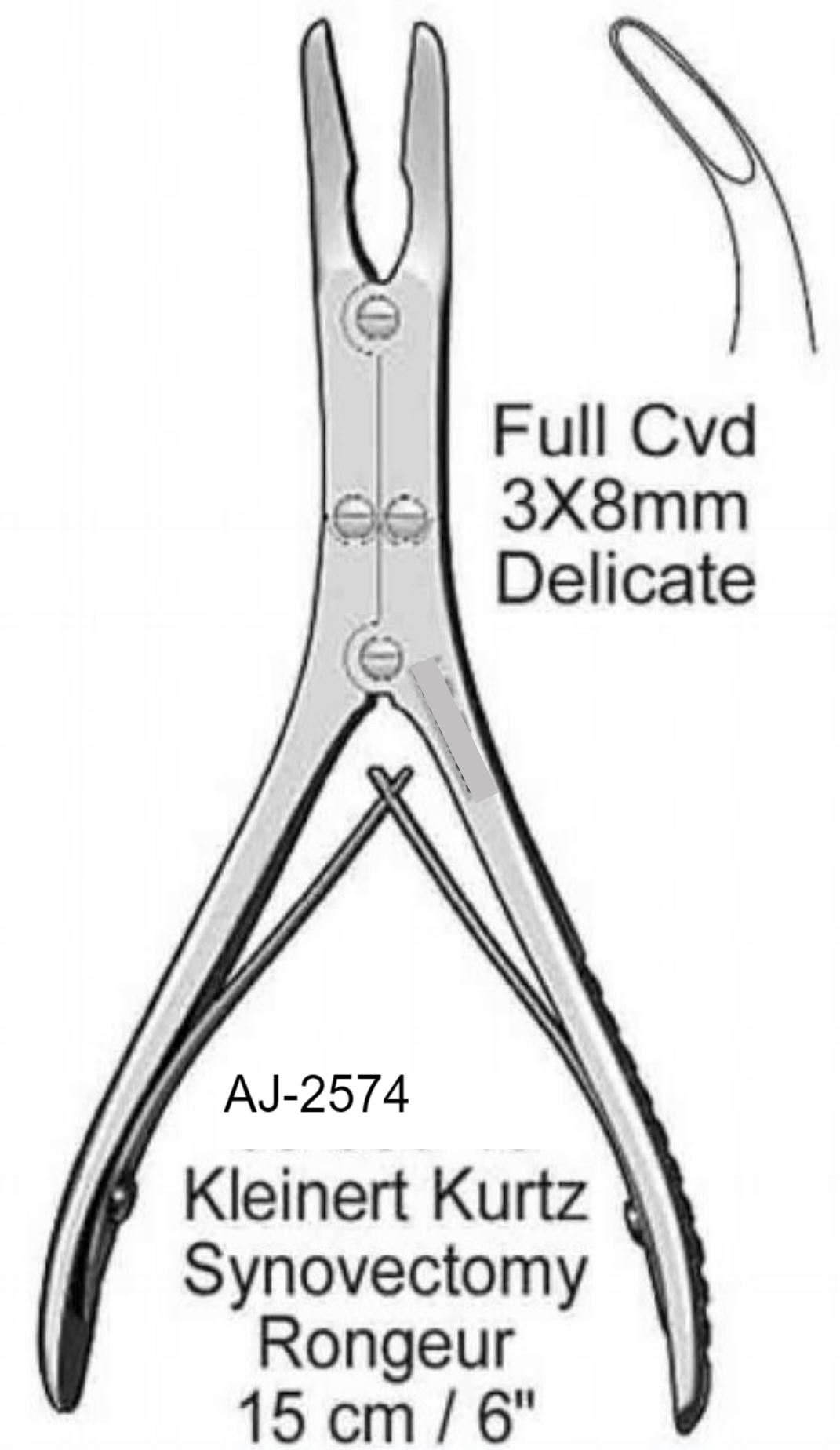
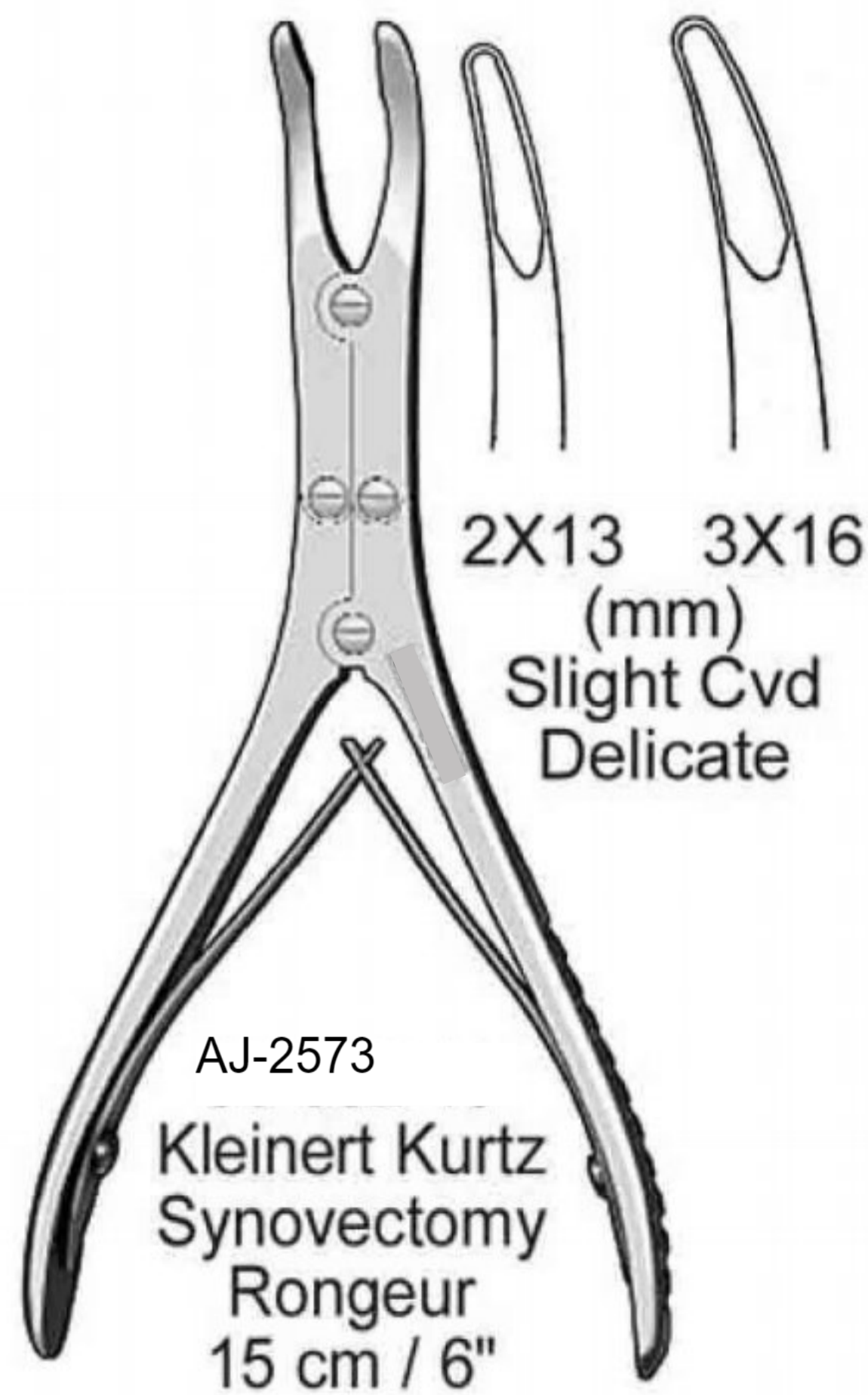
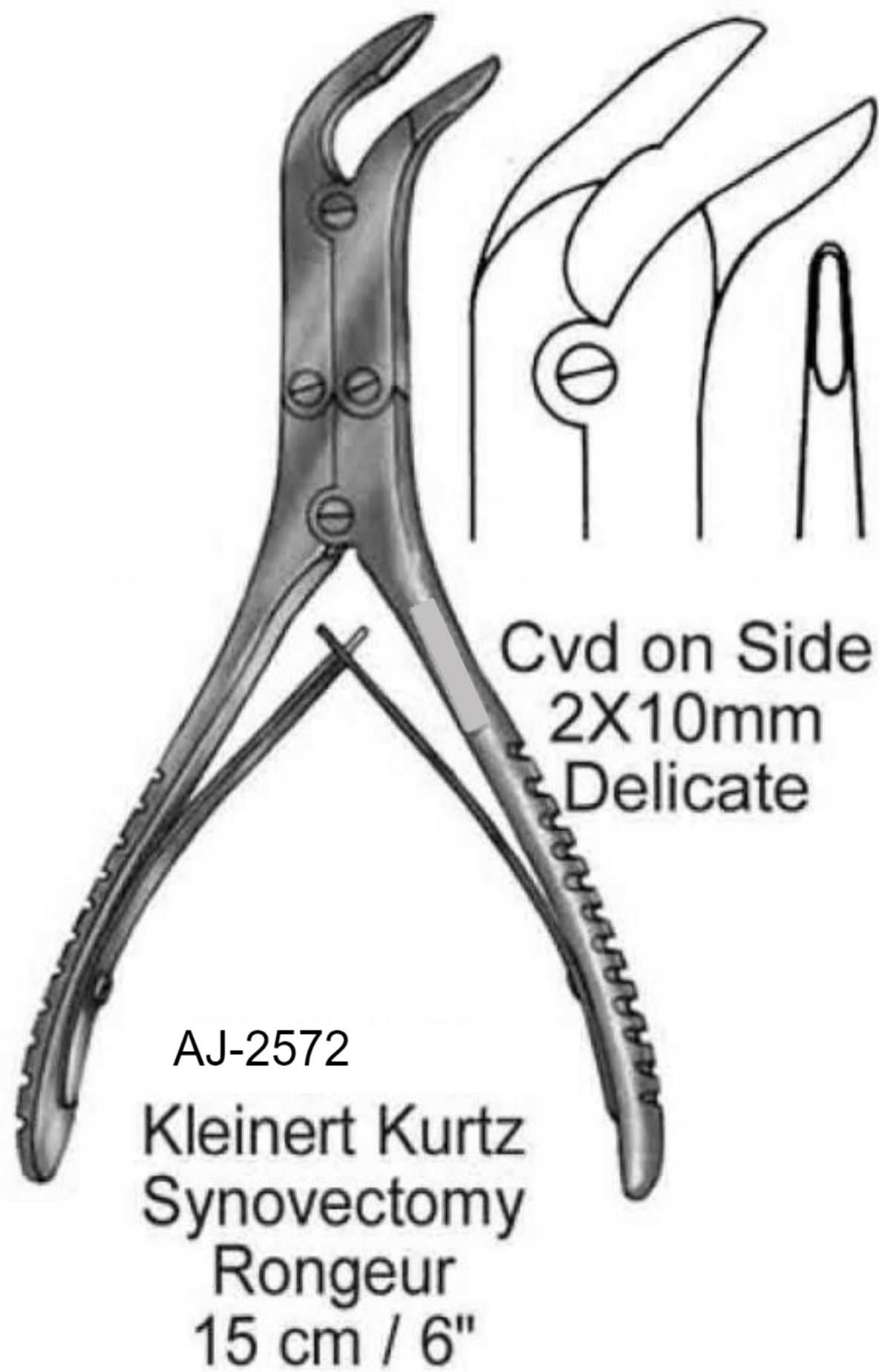
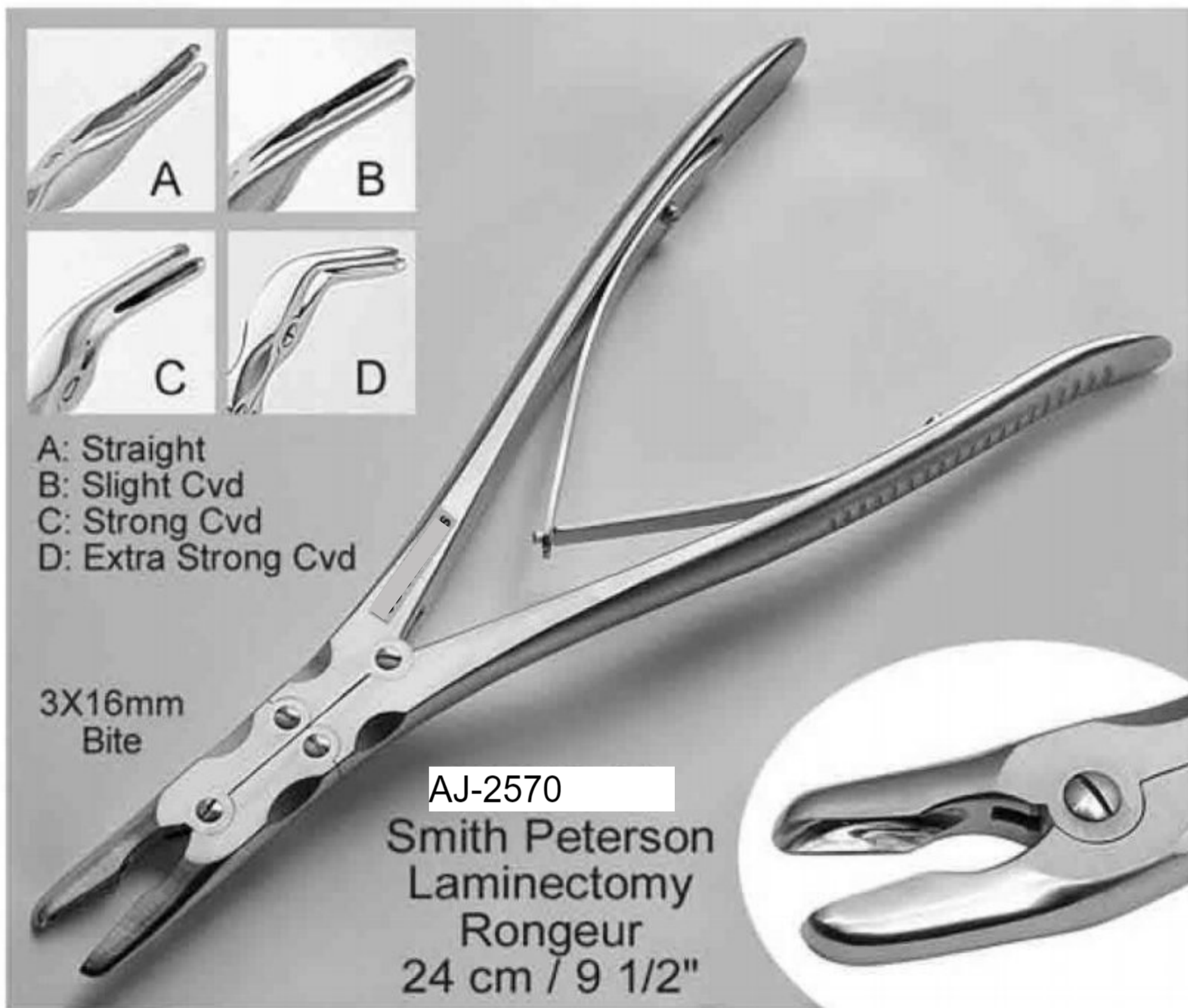
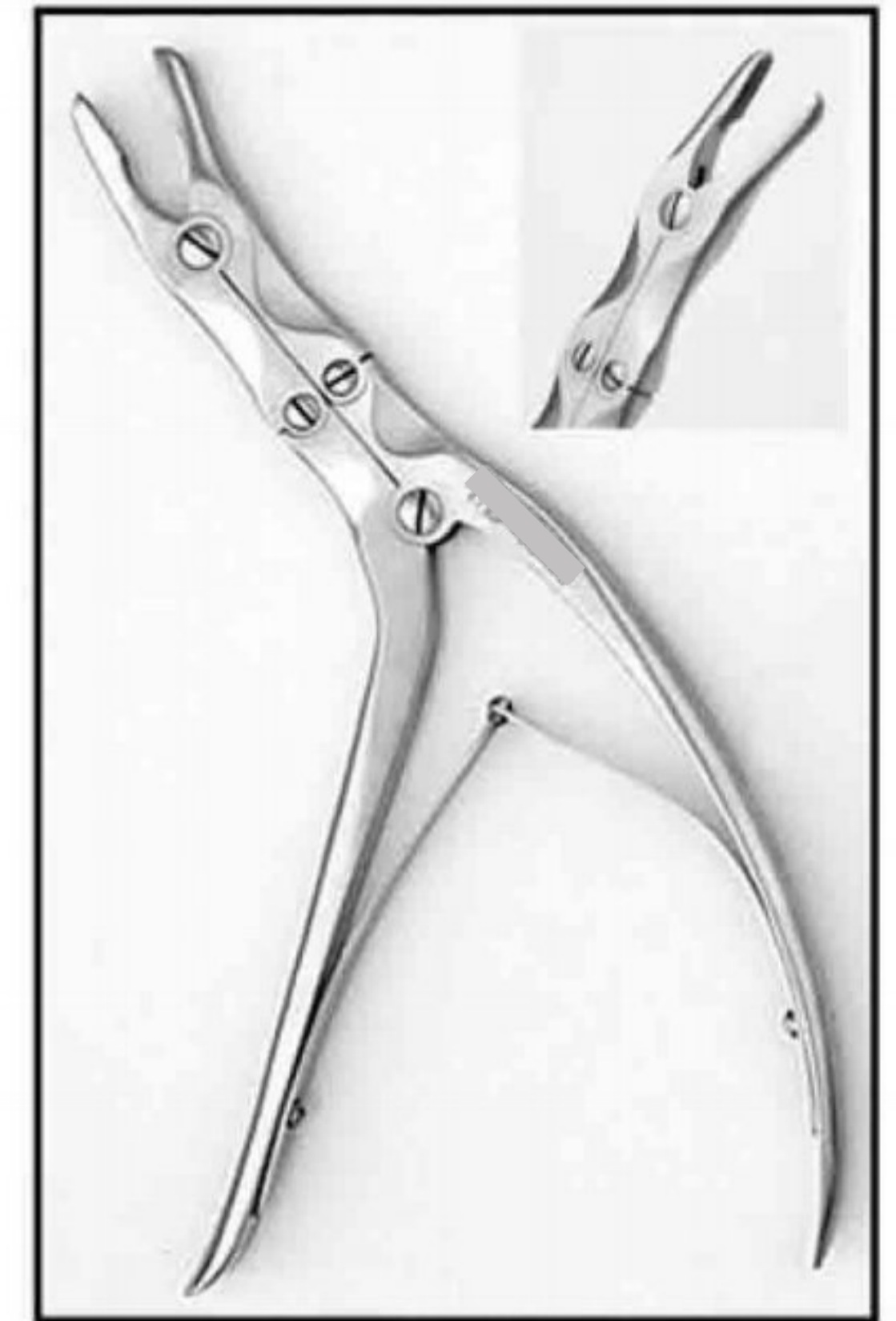
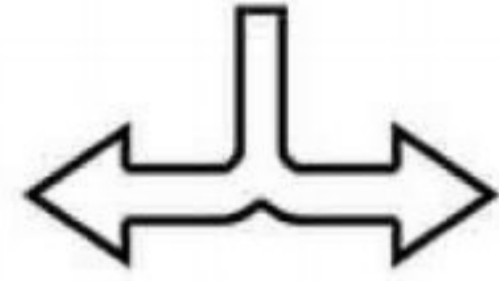

BONE RONGEURS - NIBBLERS

Tooth
Inside

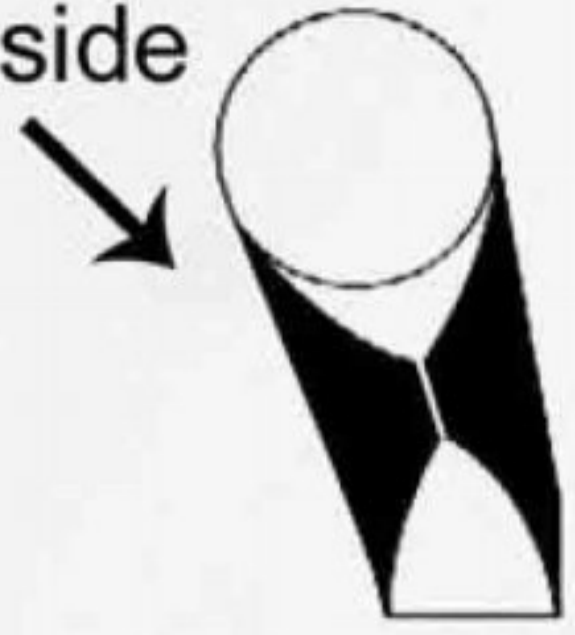

AJ-2575
Semb Bone Rongeur
23.5 cm / 9 1/4"

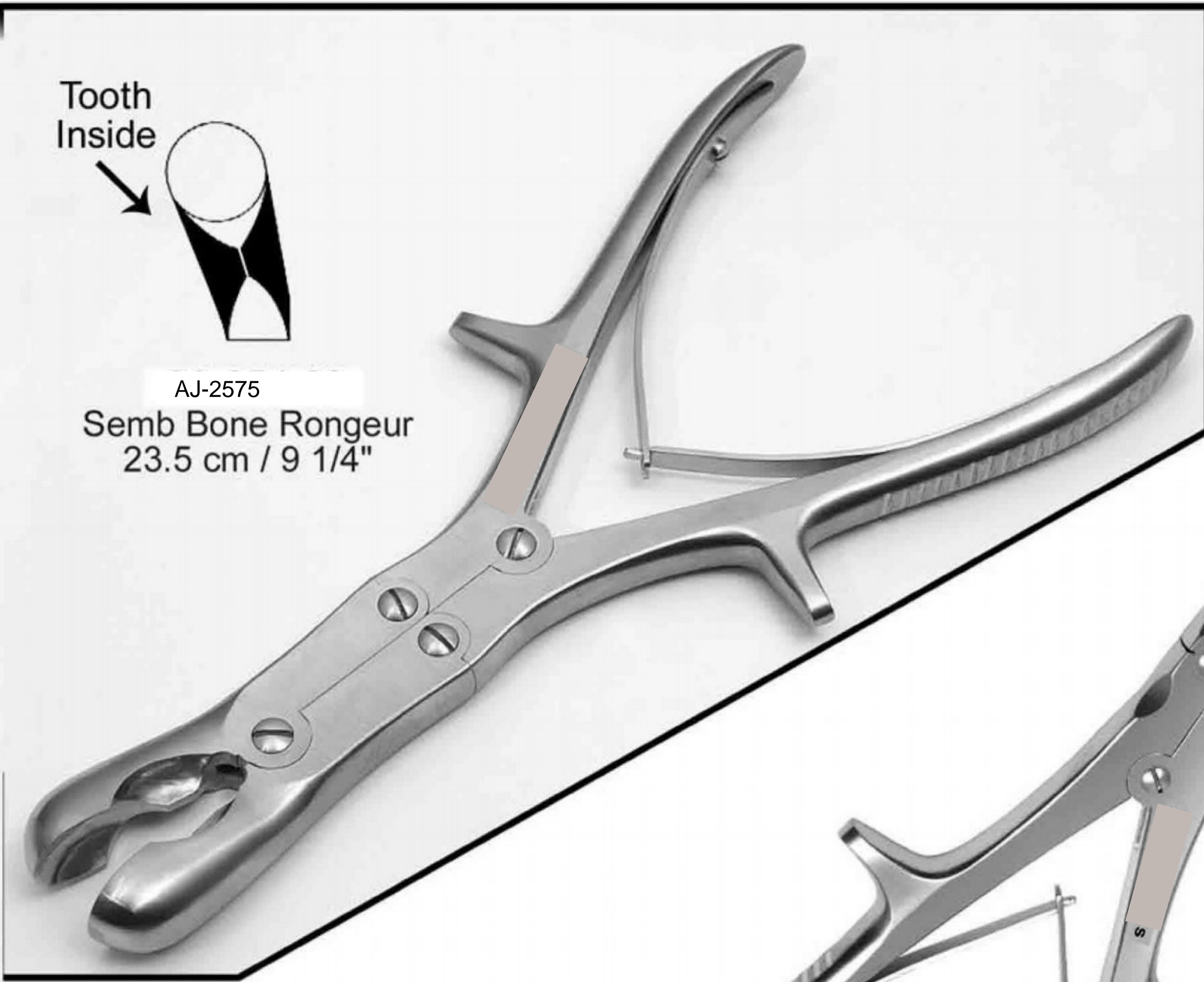

8mm

AJ-2576
Stille Ruskin
Bone Rongeur
23.5 cm / 9 1/4"

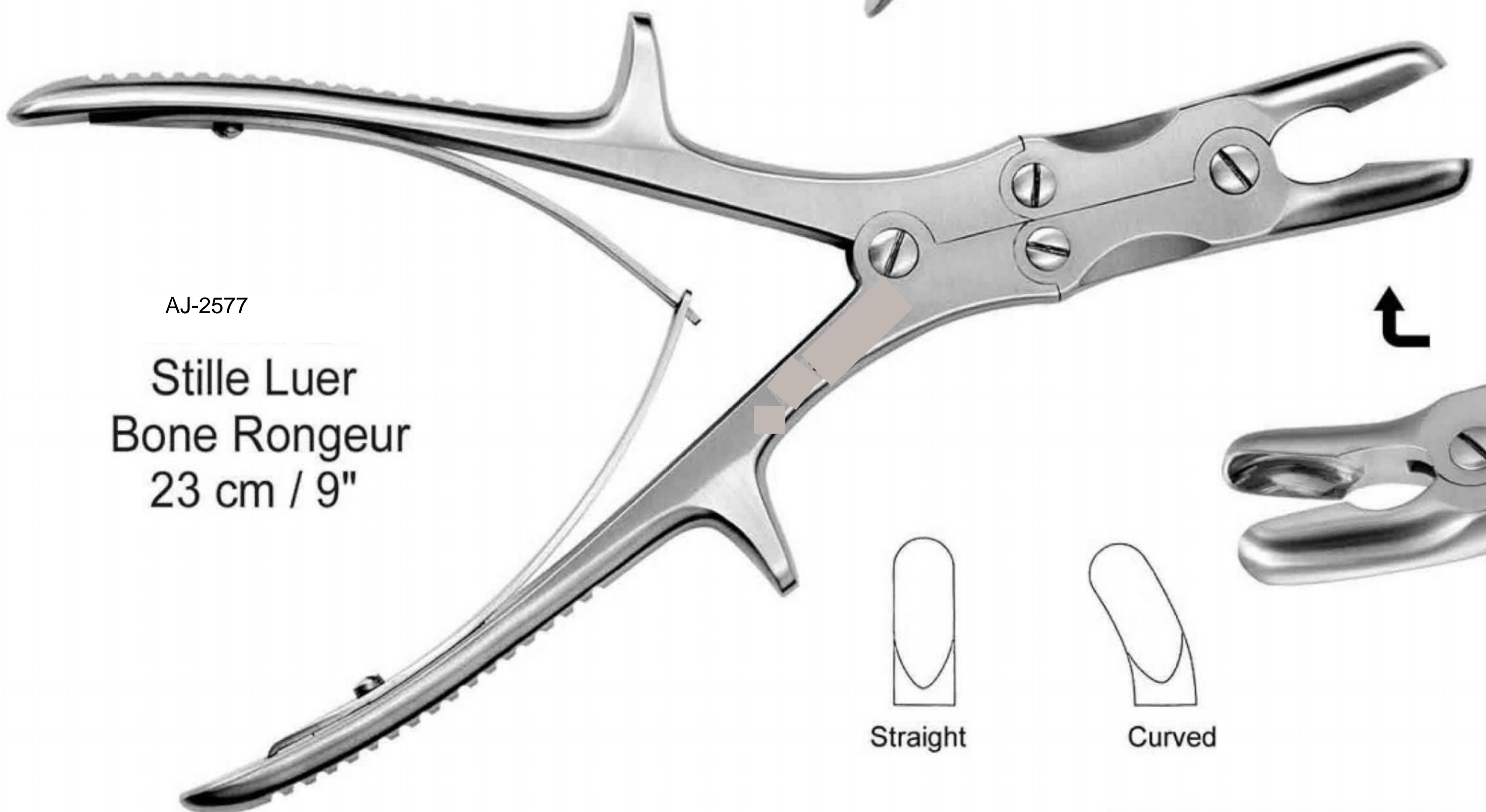
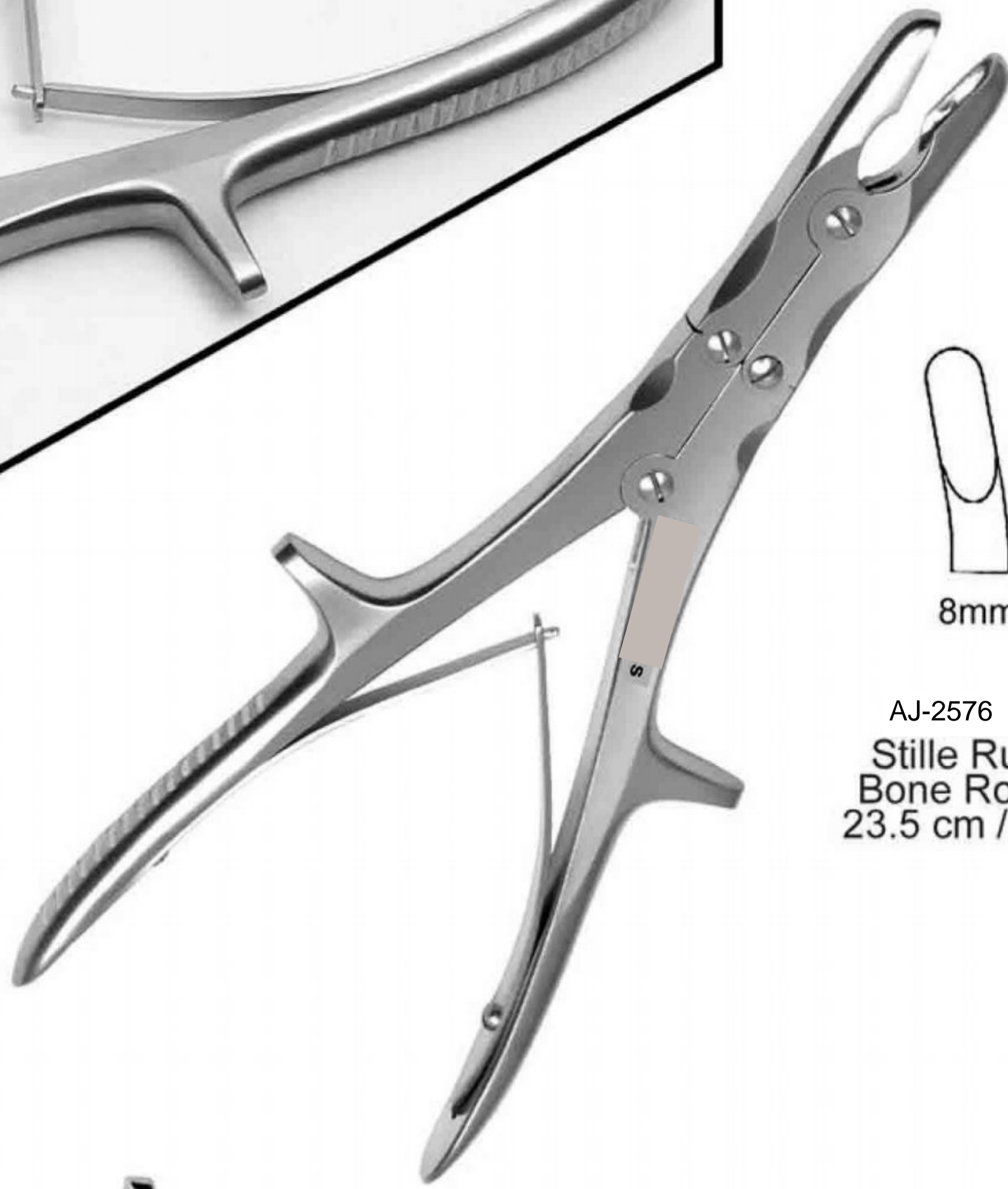

AJ-2577
Stille Luer
Bone Rongeur
23 cm / 9"



Straight



Curved

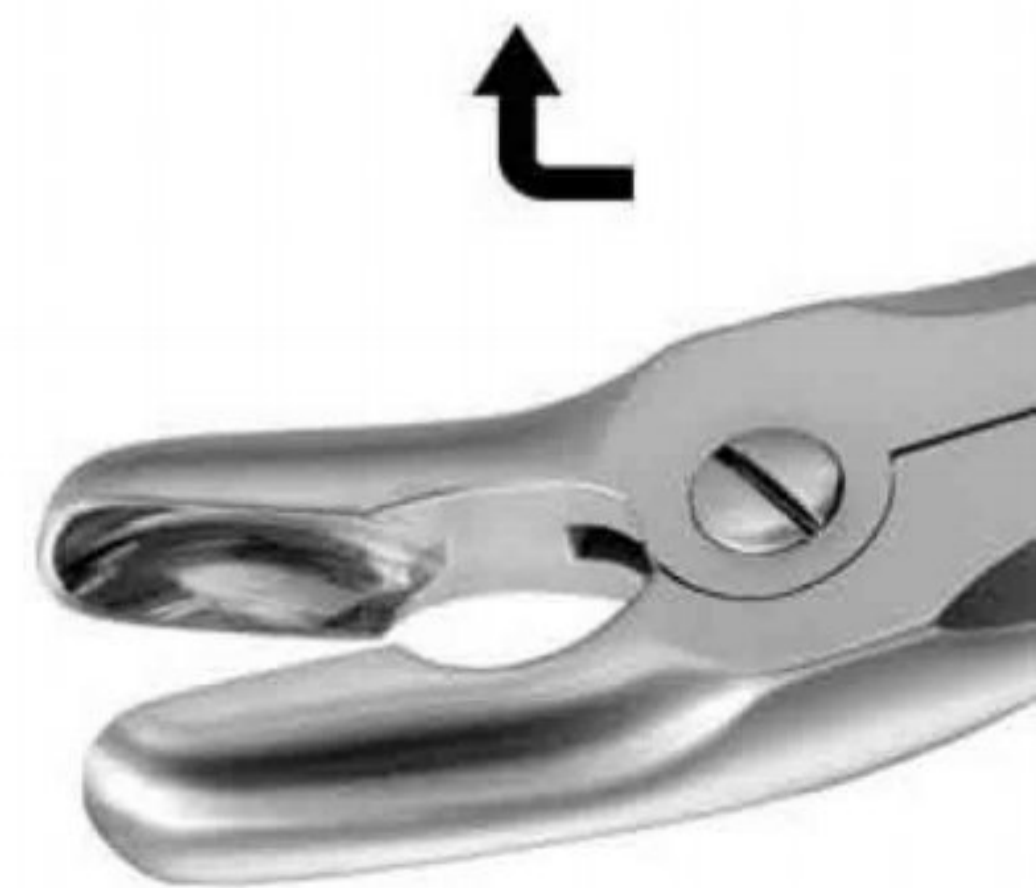

BONE RONGEURS - NIBBLERS

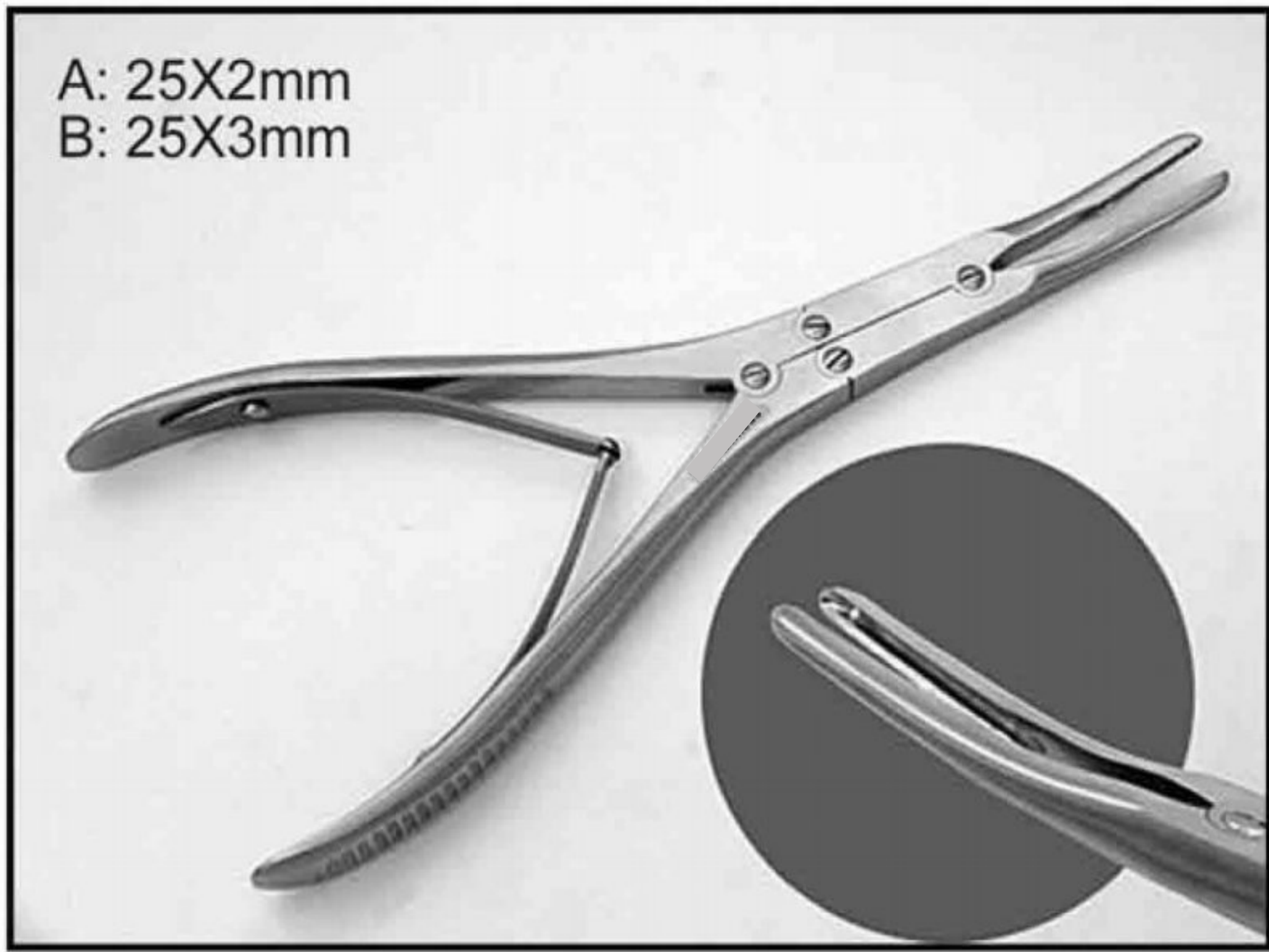

AJ-2578

Mainz Long Neck Bone Rongeur 18 cm / 7"

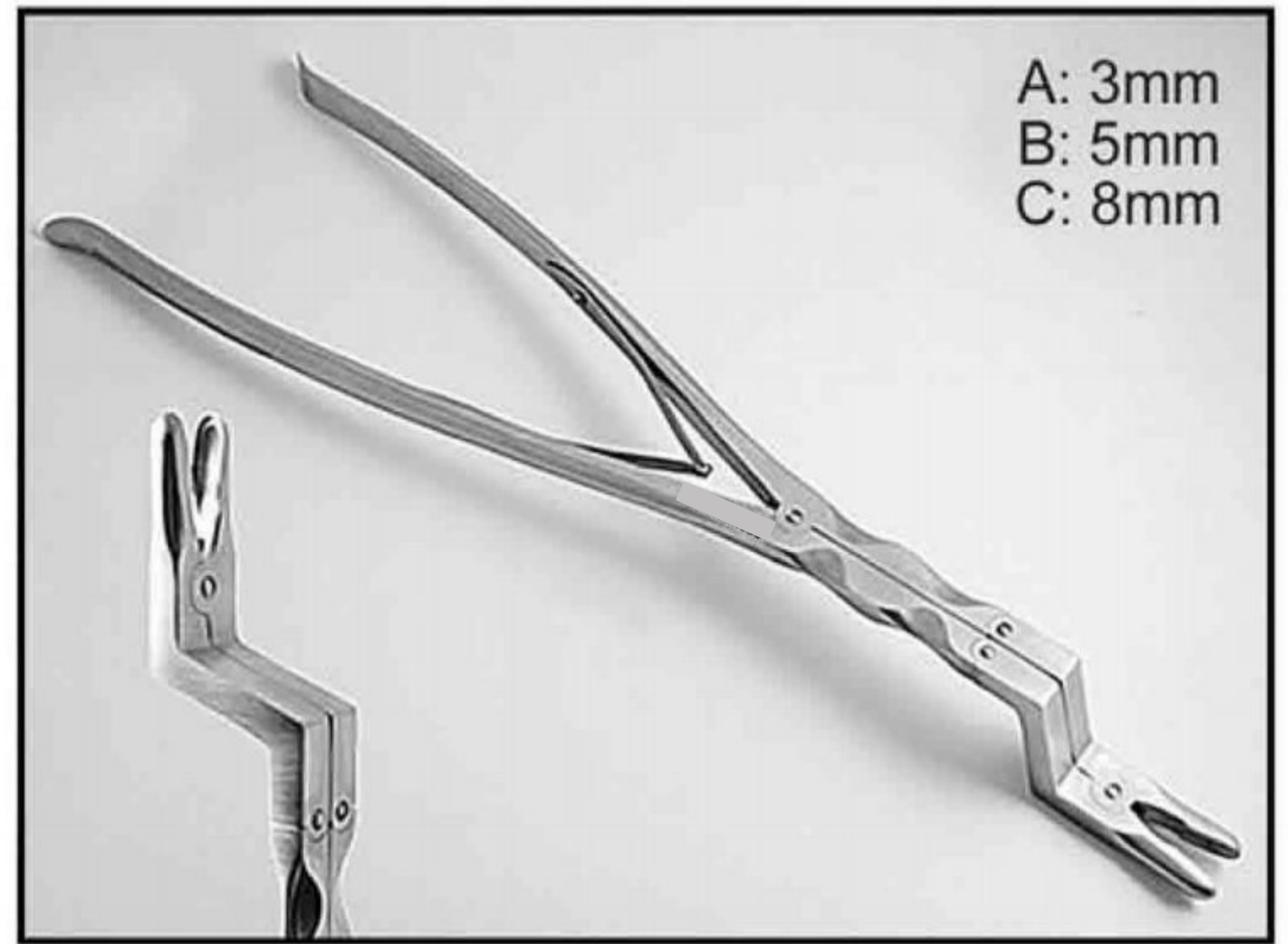

AJ-2579

Leksell Bayonet Rongeur 41 cm / 16"

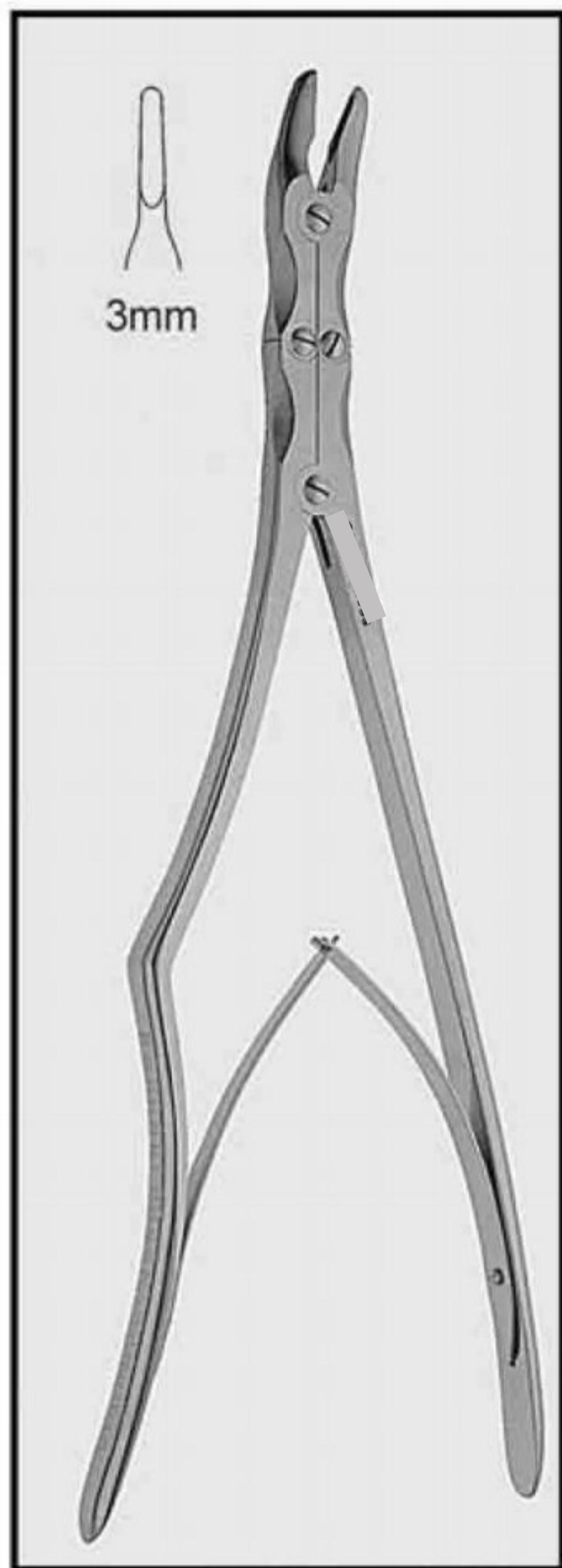
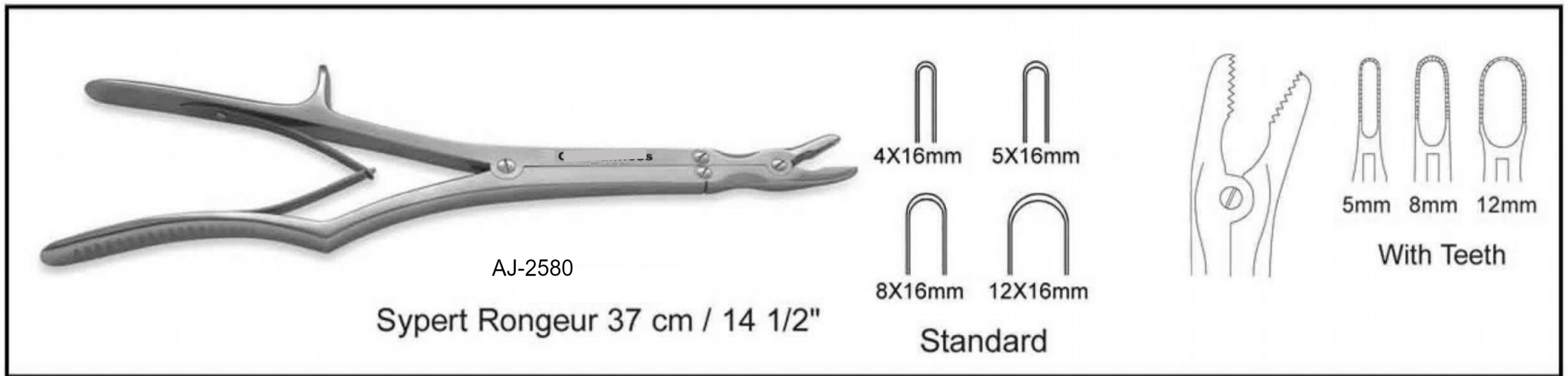

AJ-2581

Dale Thoracic Rongeur 37 cm / 14 1/2"

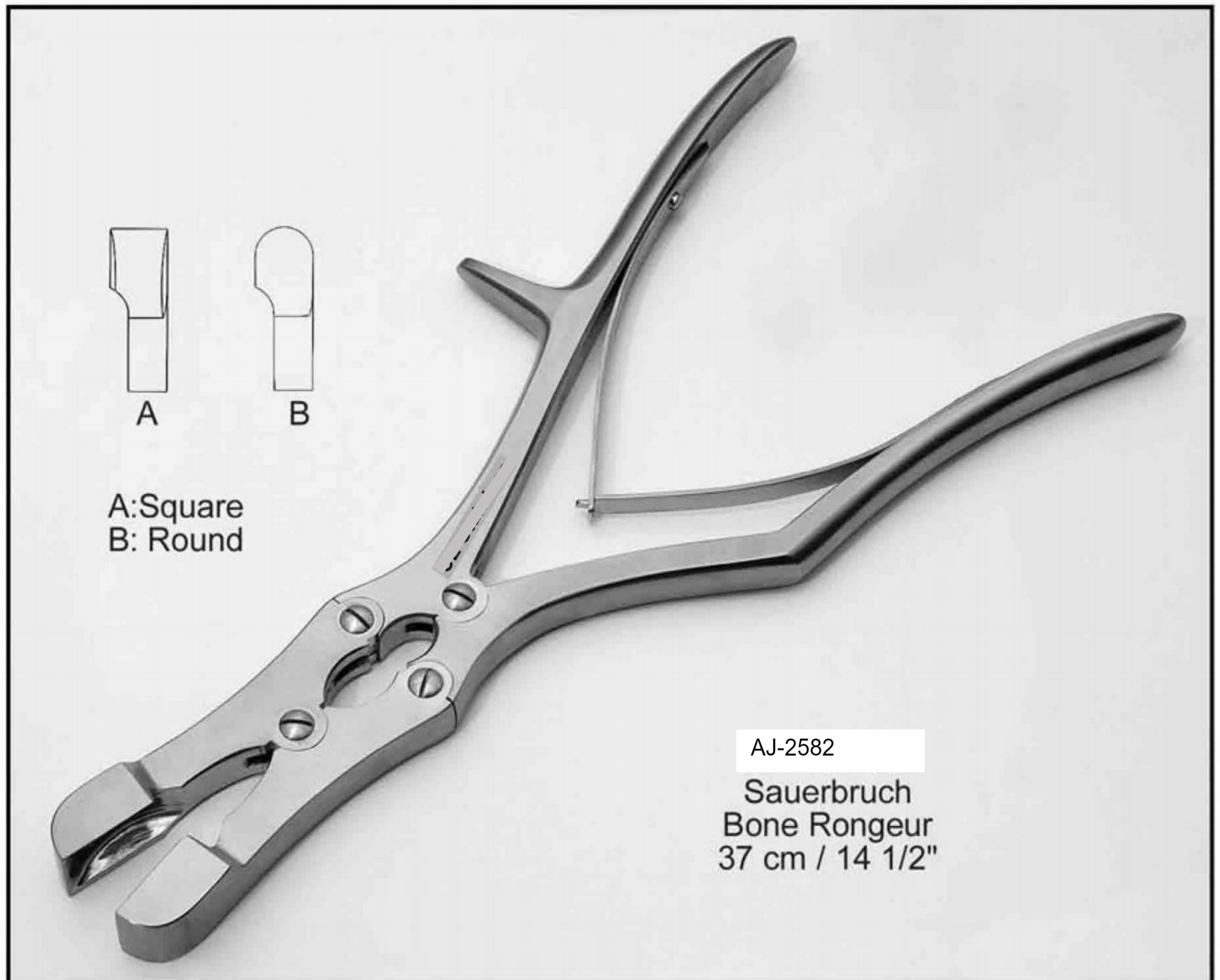

RIB SHEARS



AJ-2583
Rib Shear
Double Spring
22 cm / 8 3/4"



AJ-2584
Rib Shear
Double Spring
A: 20 cm / 8"
B: 23 cm / 9"



AJ-2585
Collin Rib Shear
17.5 cm / 7"



AJ-2586
Collin Rib Shear
17 cm / 6 3/4"



AJ-2587
Stille Rib Shear
21 cm / 8 1/4"



AJ-2588
Gluck
Rib Shear
A: 16 cm / 6"
B: 18 cm / 7"
C: 20 cm / 8"
D: 23 cm / 9"

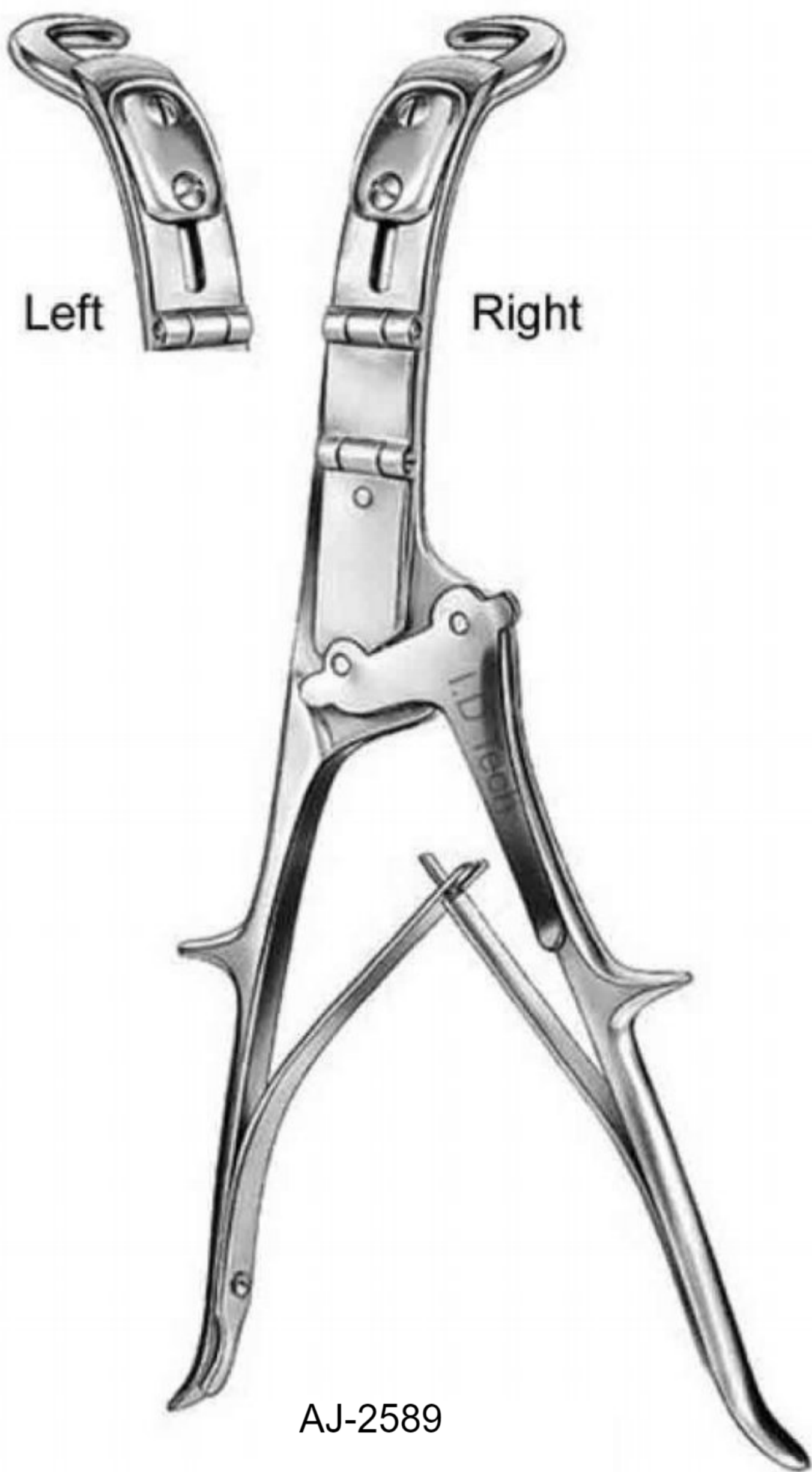

AJ-2589
Brunner
Rib Shear
28 cm / 11"



AJ-2590
Giertz Stille
Rib Shear
25 cm / 10"



AJ-2591
Sauerbruch
Rib Shear
A: 23 cm / 9"
A: 26 cm / 10 1/4"

RIB SHEARS - STERNUM CHISEL

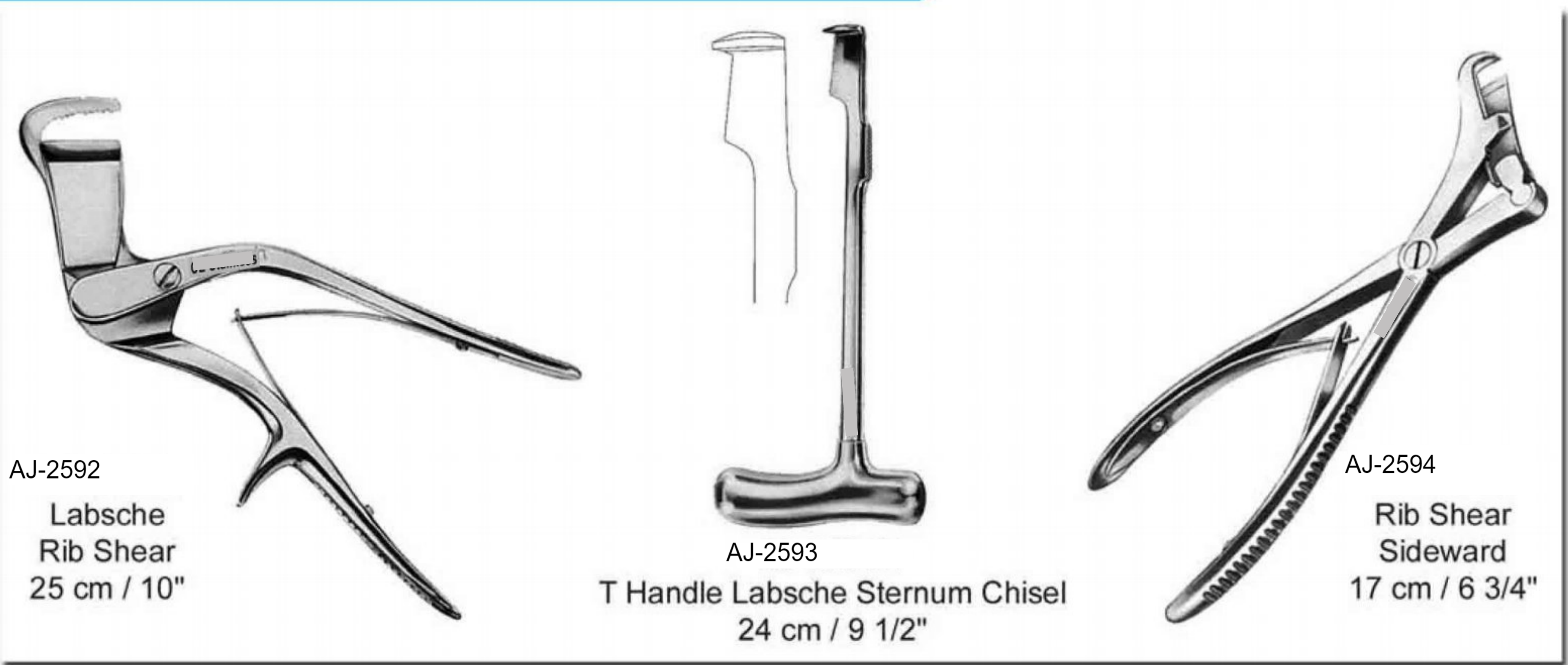

AJ-2592
Labsche
Rib Shear
25 cm / 10"

AJ-2593
T Handle Labsche Sternum Chisel
24 cm / 9 1/2"

AJ-2594
Rib Shear
Sideward
17 cm / 6 3/4"



Pointed
Tips

AJ-2595 A
Bethune Rib Shear
S Shaped Handle
34 cm / 13 1/2"

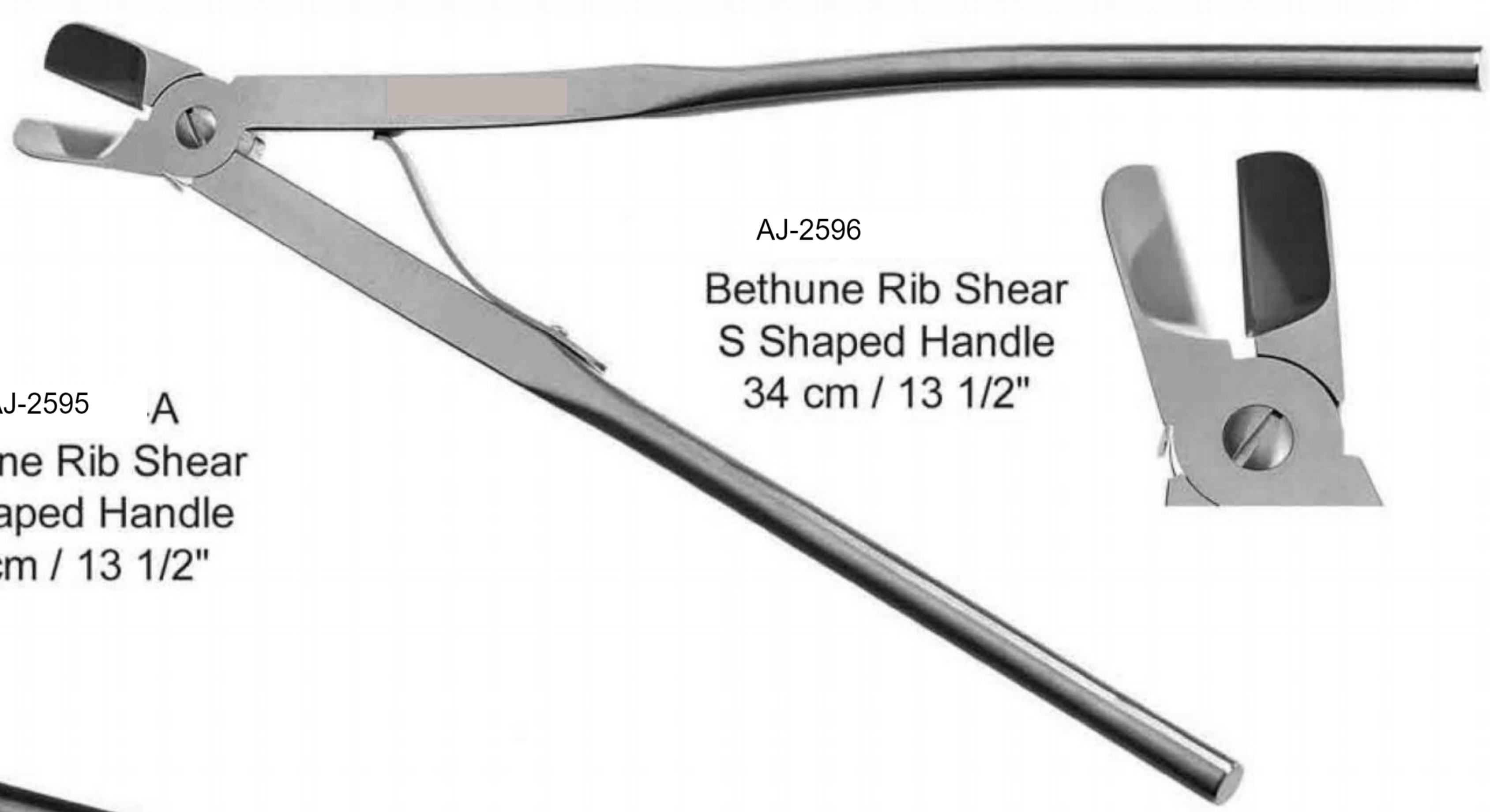

AJ-2596
Bethune Rib Shear
S Shaped Handle
34 cm / 13 1/2"

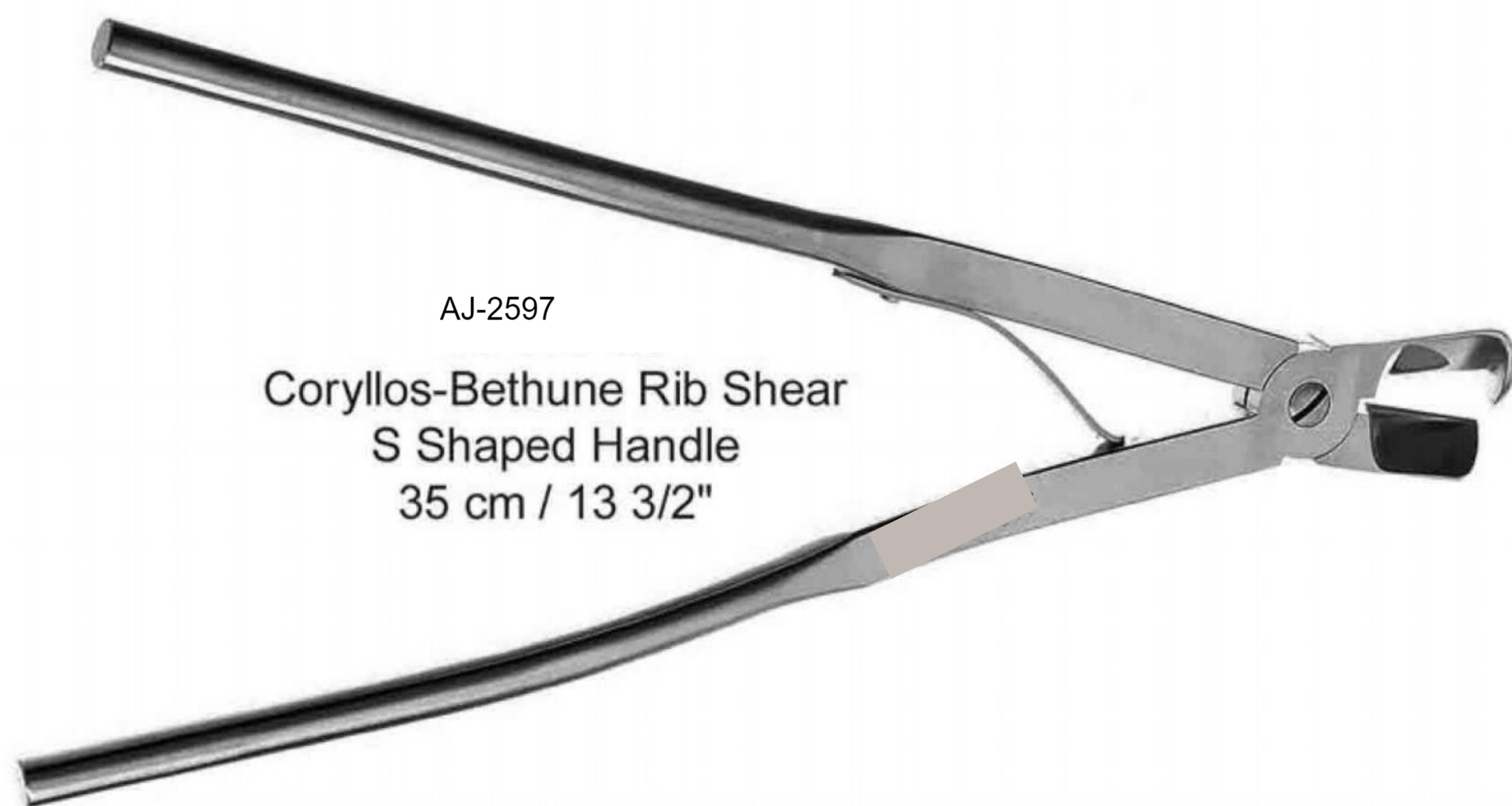

AJ-2597
Coryllos-Bethune Rib Shear
S Shaped Handle
35 cm / 13 3/2"

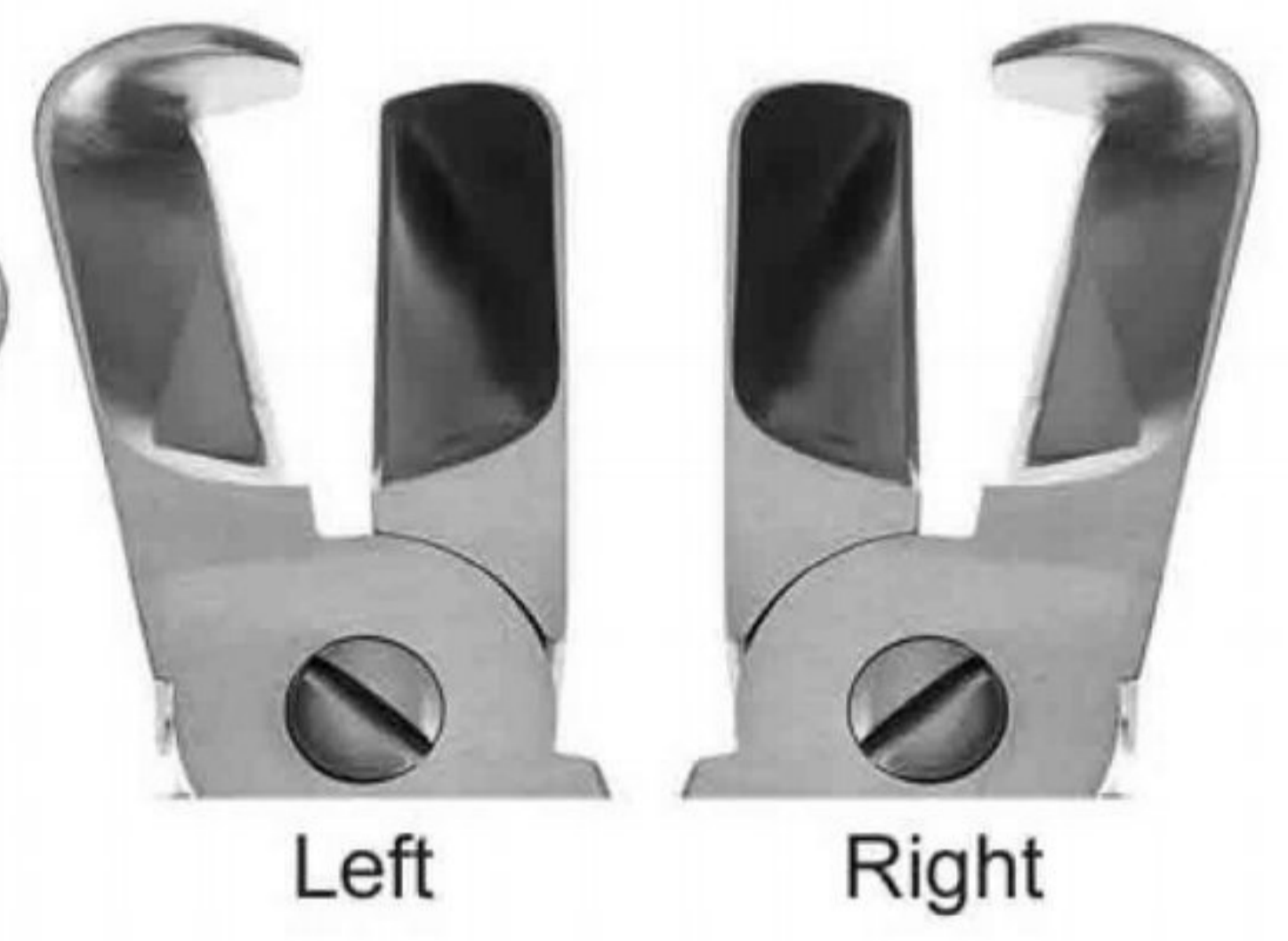

Left

Right



AJ-2598
Roos Rib Shear
Right Angled Jaw W/ Hook
33 cm / 13"

SPREADERS

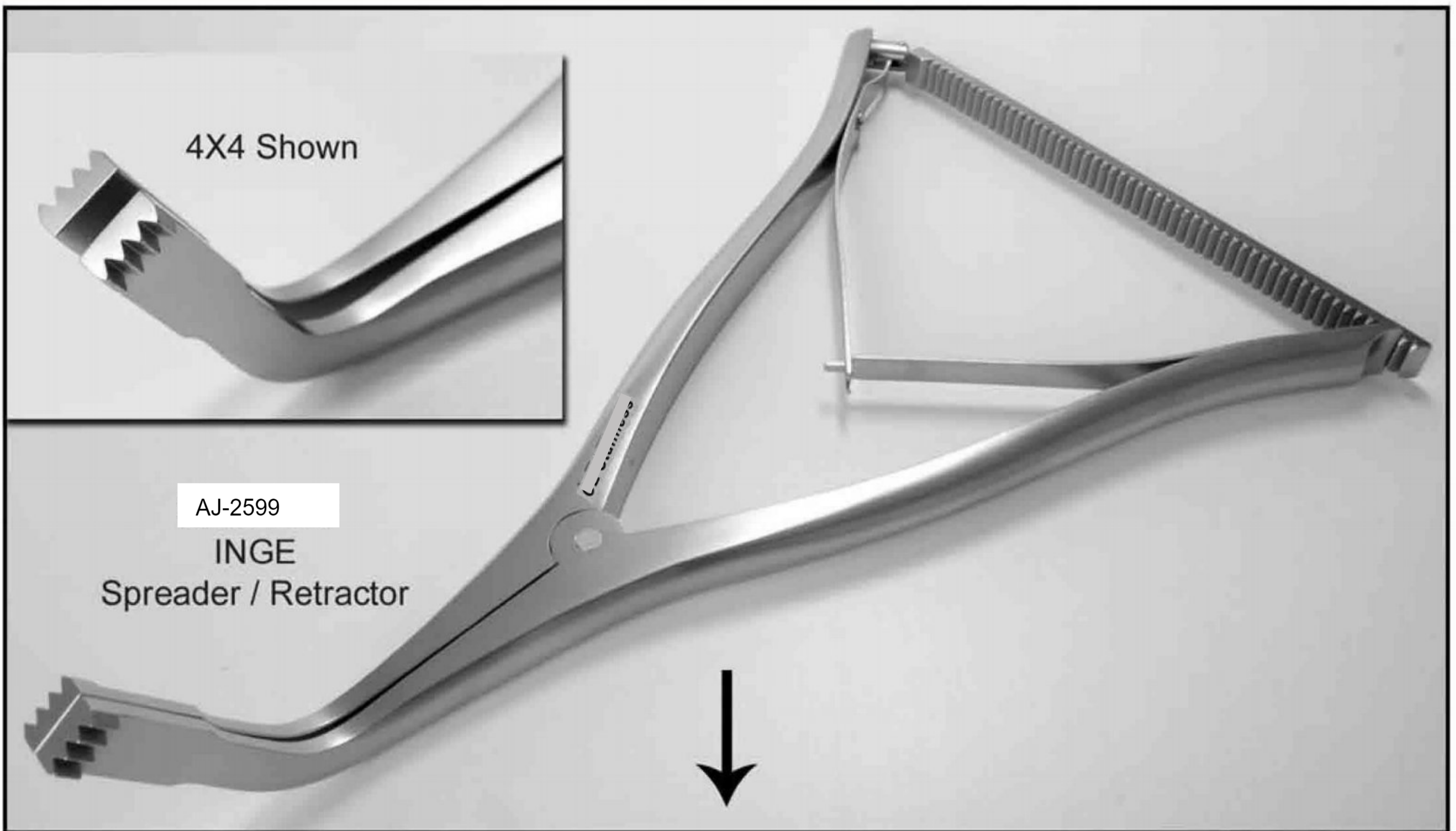

Available in 4X4 and 6X6 Teeth
and Without Teeth (Plain)

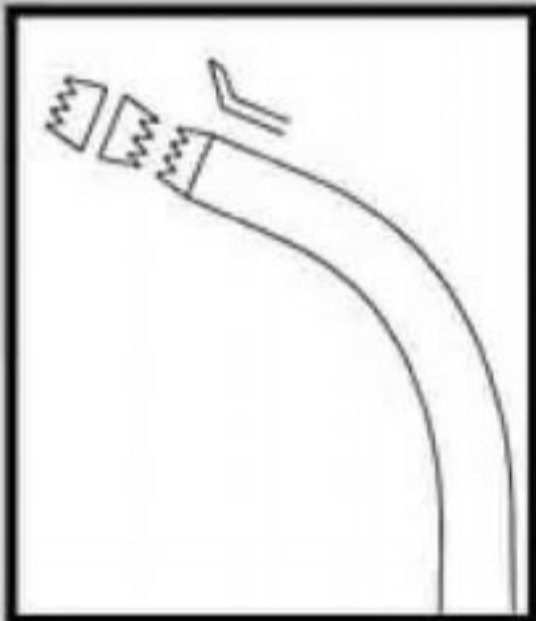

A: 4X4 Teeth
B: Without Teeth
16.5 cm / 6 1/2"

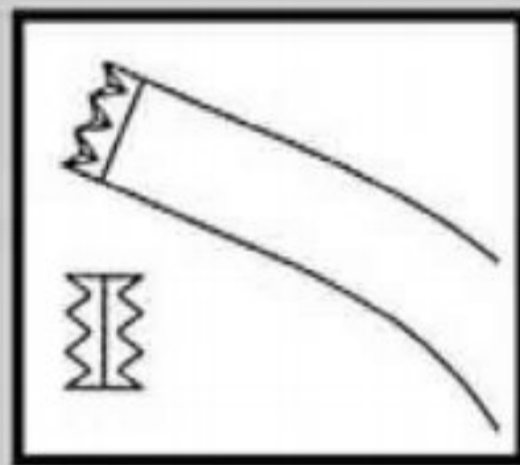

C: 4X4 Teeth
D: Without Teeth
25.5 cm / 10"

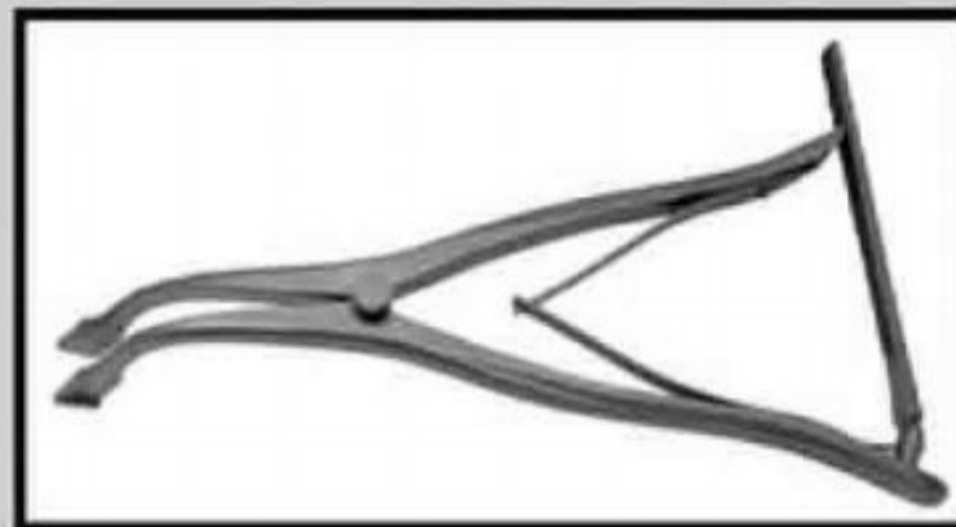

10 Inch Length Pattern

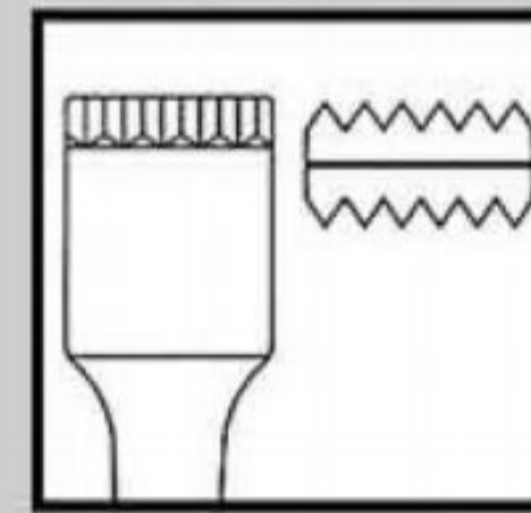

A: 6X6 Teeth
B: Without Teeth
27 cm / 10 1/2"
Flat Blades

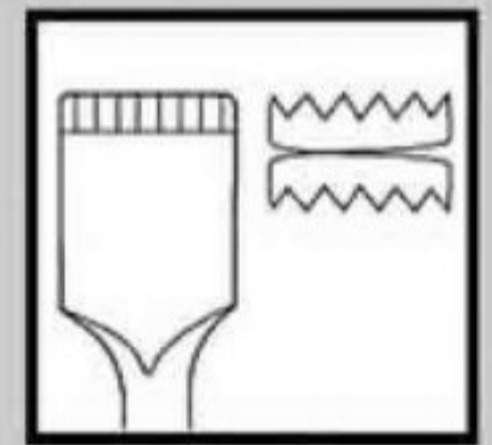

C: 6X6 Teeth
C: Without Teeth
27 cm / 10 1/2"
Concave Blades

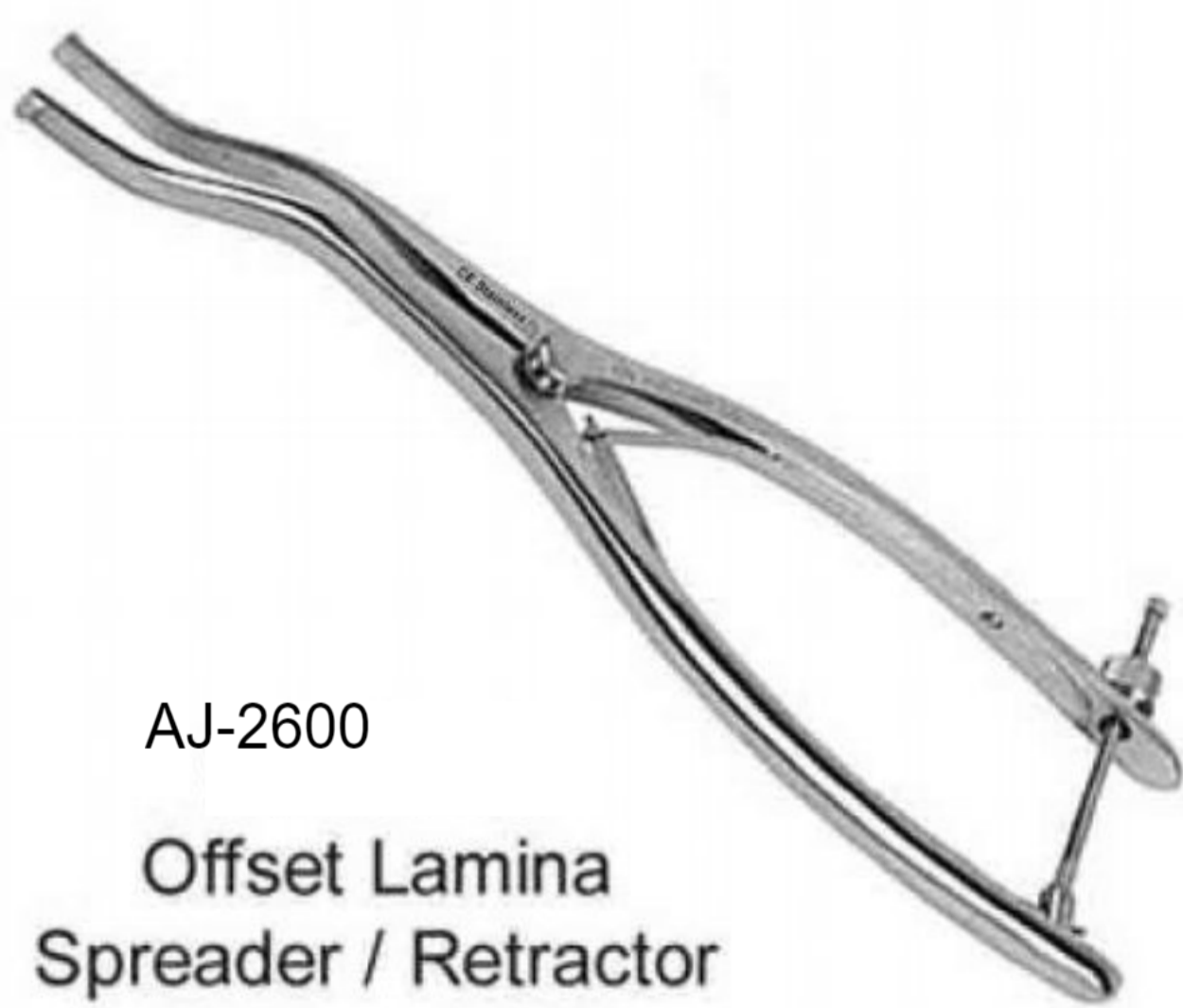

AJ-2600

Offset Lamina
Spreader / Retractor
25.5 cm / 10"

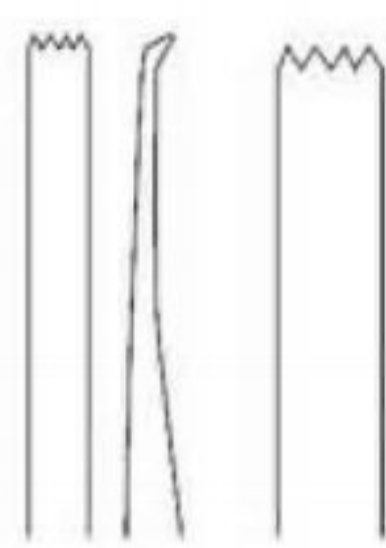

AJ-2601

Vertebra
Spreader
/ Retractor
A: 18 cm / 7"
B: 28 cm / 11"



AJ-2602

Inge Spreader
Serrated Outside
Blades
A: 18 cm / 7"

AJ-2603
Saxsena Lamina
Spreader / Retractor
A: 18 cm / 7"
B: 25.5 cm / 10"
Serrated Outside
Blades

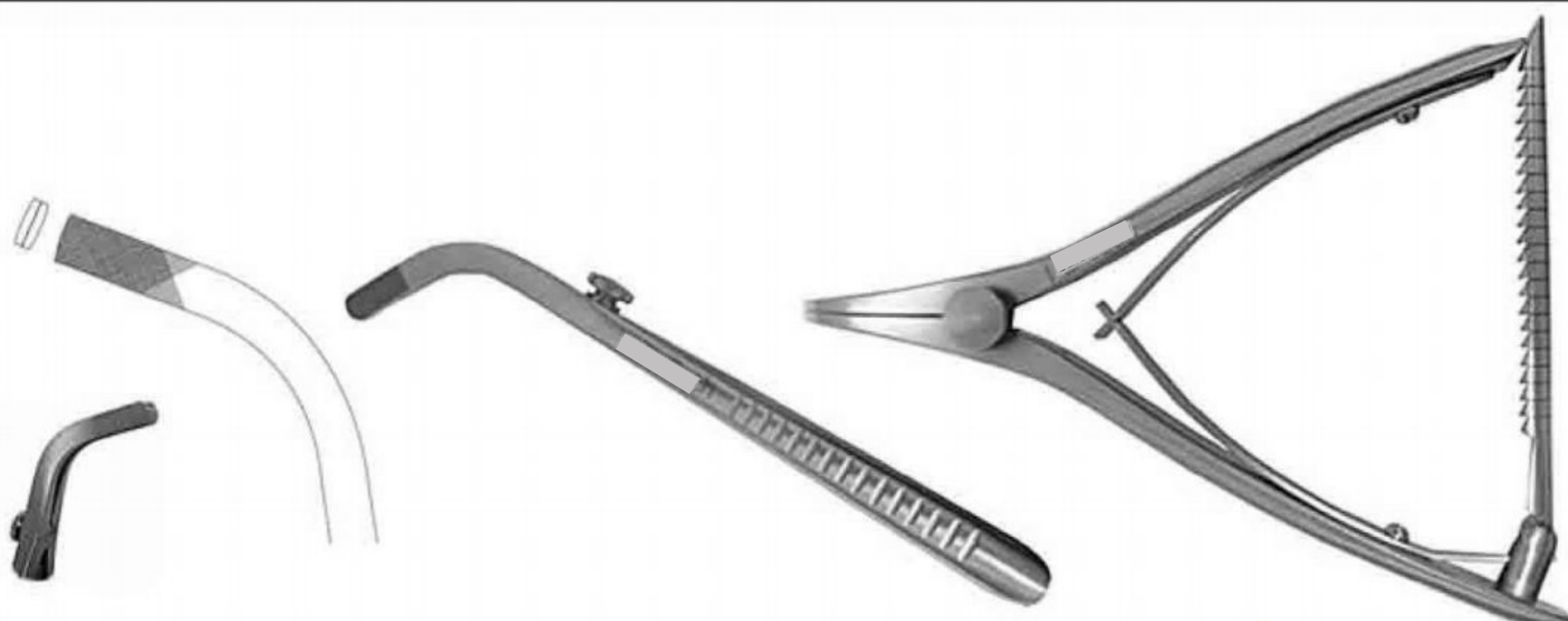

SPREADERS



AJ-2604
Calcaneal Spreader
 Smooth Pads 15X12mm
 18 cm / 7"



AJ-2605
Calcaneal Spreader
 Grooved Pads 15X12mm
 18 cm / 7"



AJ-2606
Lombardi Femoral Tibial Spreader (Small)
 A: Grooved Pads 22X13mm
 18 cm / 7"



B: Damond Cut Pads 22X13mm



B: Damond Cut Pads 22X13mm



AJ-2607
Lombardi Femoral Tibial Spreader (Large)
 A: Grooved Pads 22X13mm
 23.5 cm / 9 1/4"

COMPRESSION - DISTRACTING FORCEPS



AJ-2608
 Compressing Forceps
 28 cm / 11"
 Adjustable Locking
 For Screws and Rods



AJ-2609
 Distracting Forceps
 23 cm / 9"
 Long Ratchet / Spiral Prong
 For Screws and Rods



AJ-2610
 Distracting Forceps
 25.5 cm / 10"
 Leaf Prong
 For Screws and Rods



AJ-2611
 Compression Forceps
 28 cm / 11"
 Leaf Prong / Long Ratchet
 For Screws and Rods



AJ-2611
 Distractor
 25.5 cm / 10"
 Leaf Prong
 For Screws and Rods

PLATE BENDERS

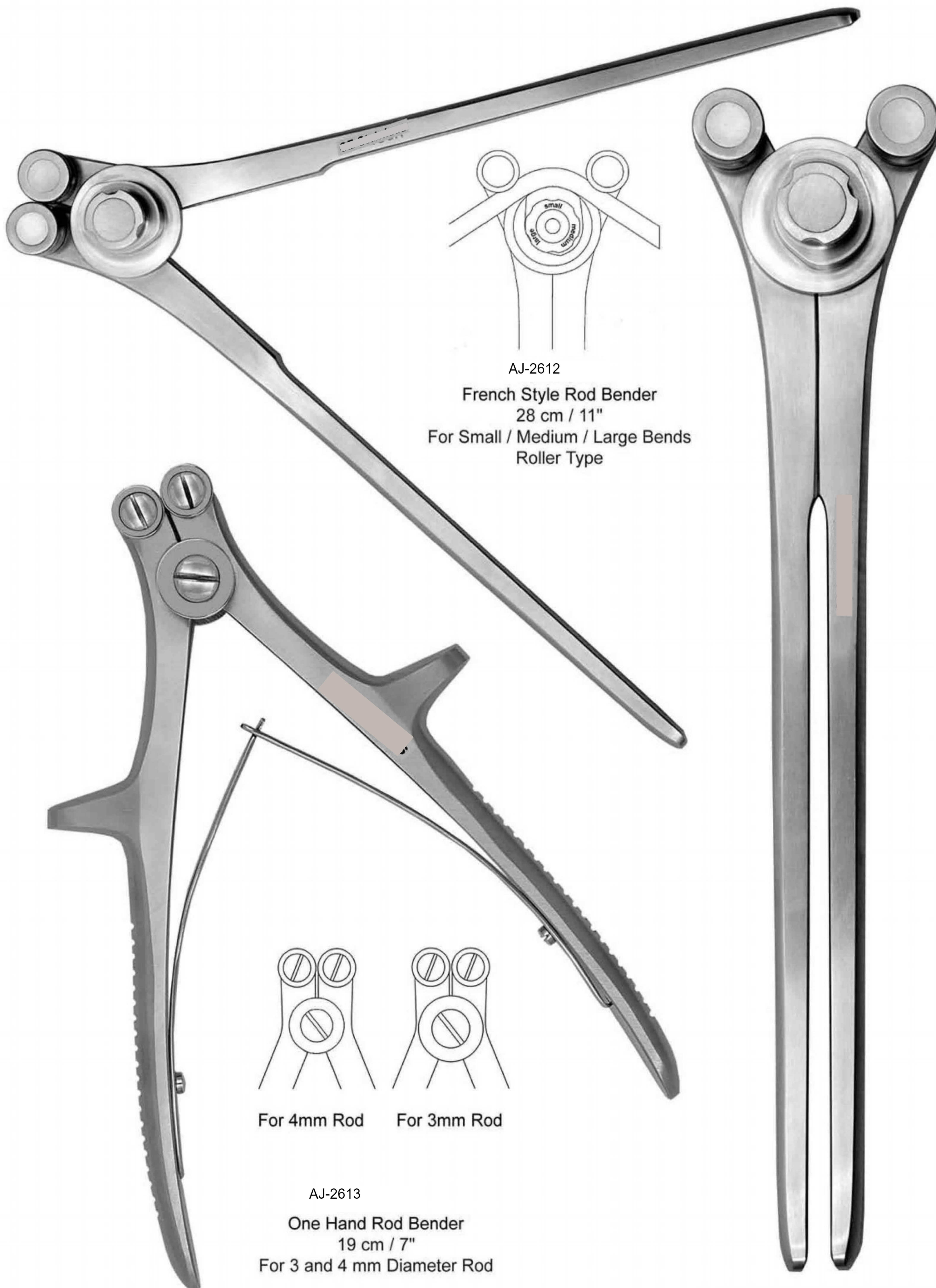

AJ-2612
French Style Rod Bender
28 cm / 11"
For Small / Medium / Large Bends
Roller Type

For 4mm Rod For 3mm Rod

AJ-2613
One Hand Rod Bender
19 cm / 7"
For 3 and 4 mm Diameter Rod

CARBIDE INSERTED WIRE TWISTERS

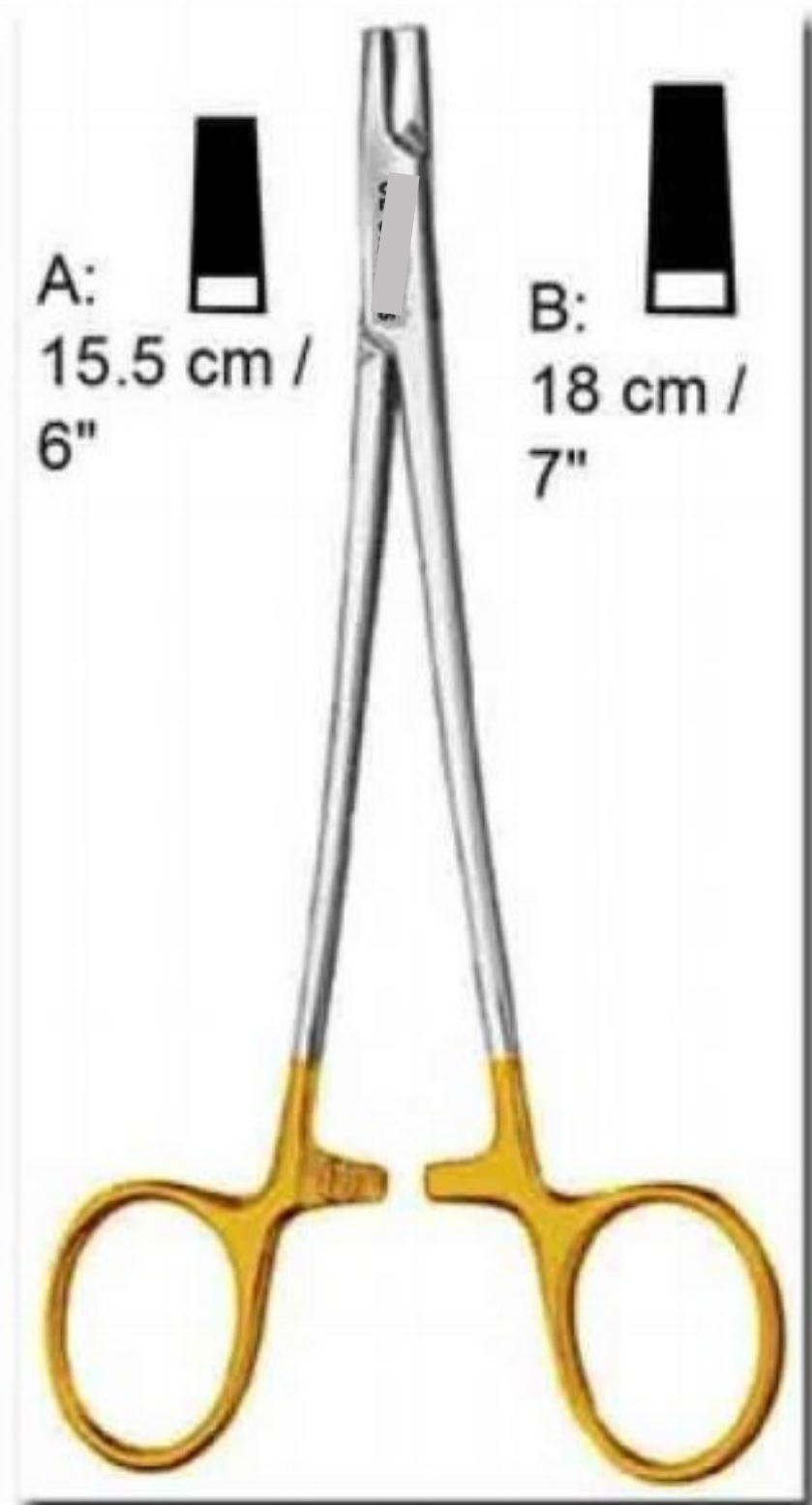

A: 15.5 cm / 6"
B: 18 cm / 7"

AJ-2614
Wire Twisting Forceps

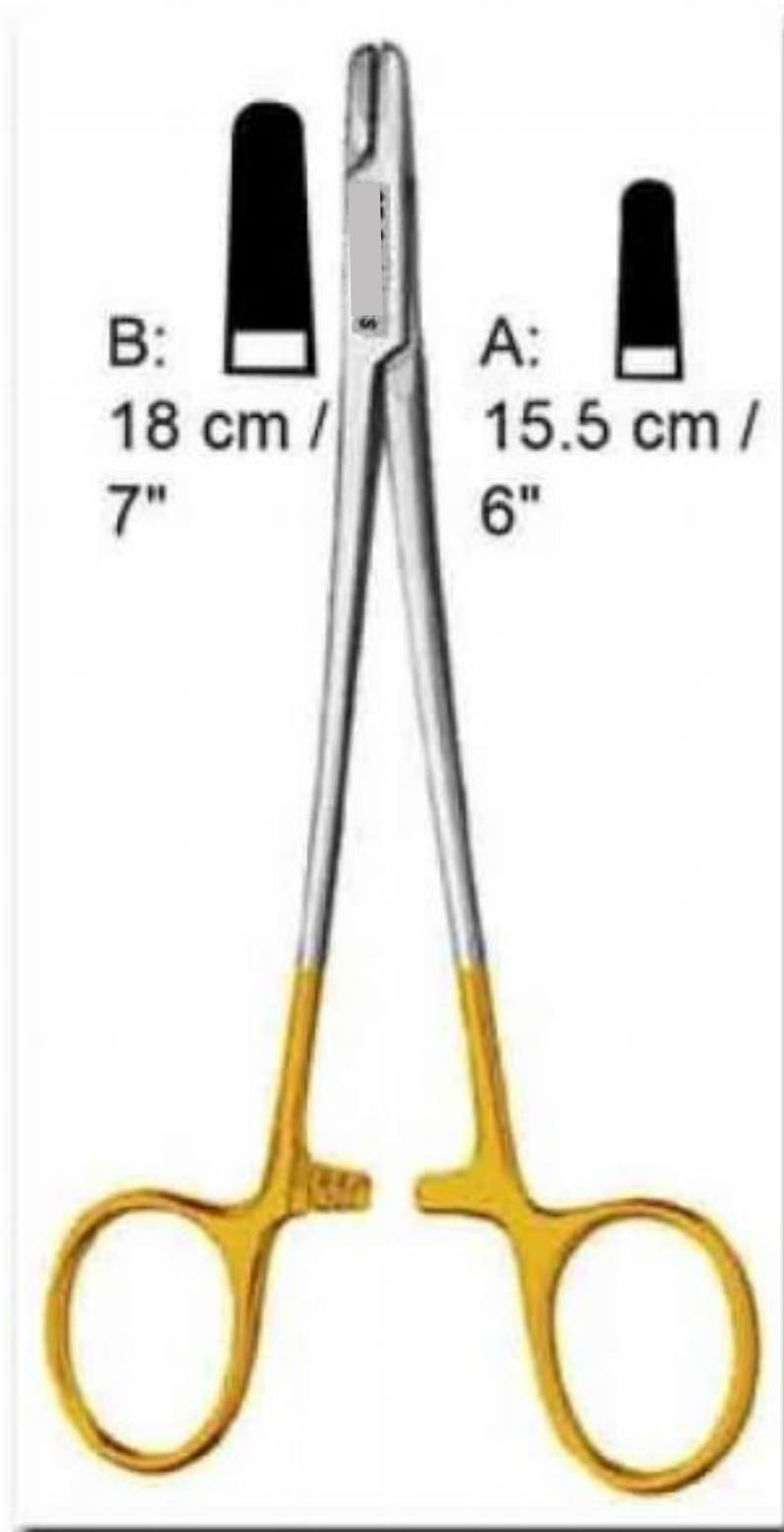

B: 18 cm / 7"
A: 15.5 cm / 6"

AJ-2615
Wire Twisting Forceps

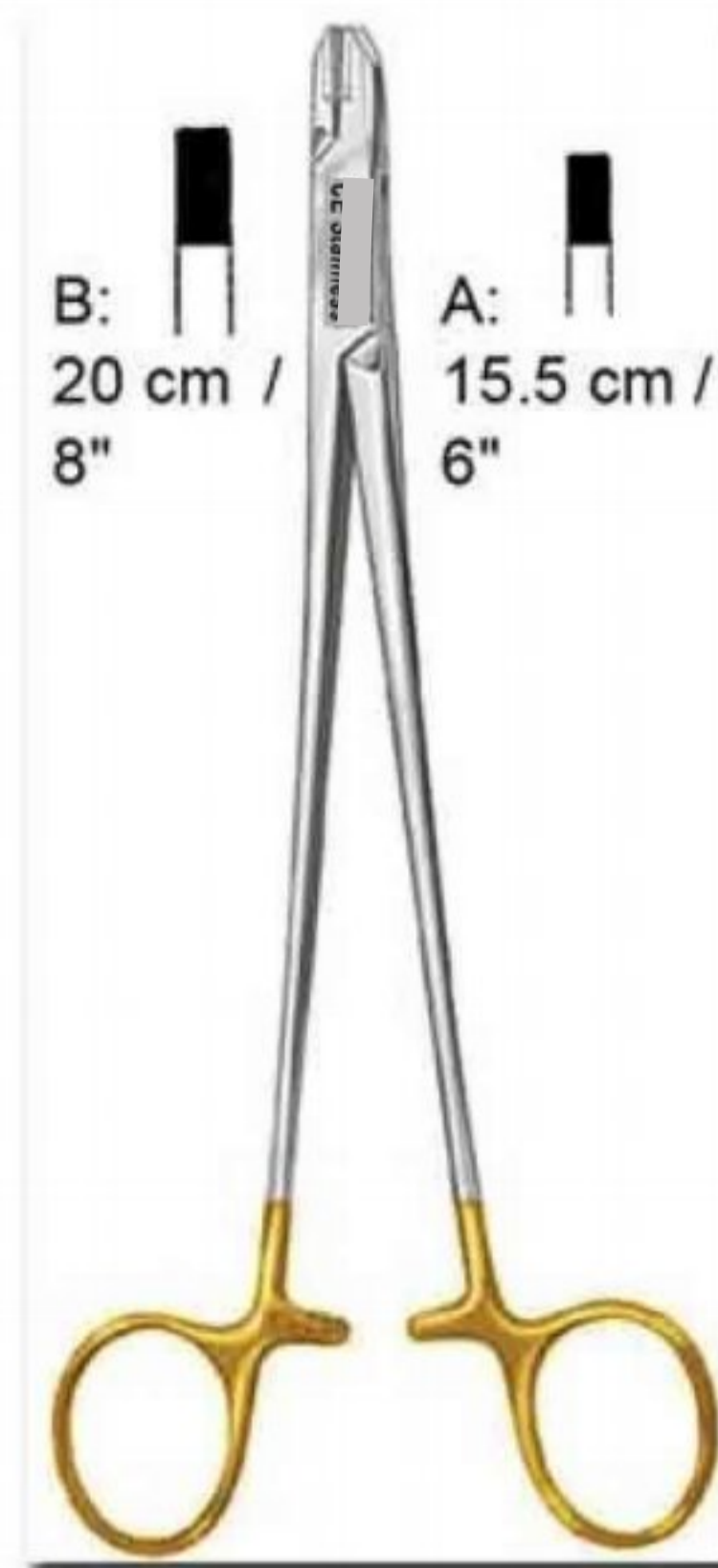

B: 20 cm / 8"
A: 15.5 cm / 6"

AJ-2616
Wire Twisting Forceps



AJ-2617 Corwin
Combi-Wire Twisting Forceps
18.5 cm / 7 1/4"



AJ-2618
Wire Twisting Forceps
15.5 cm / 6"

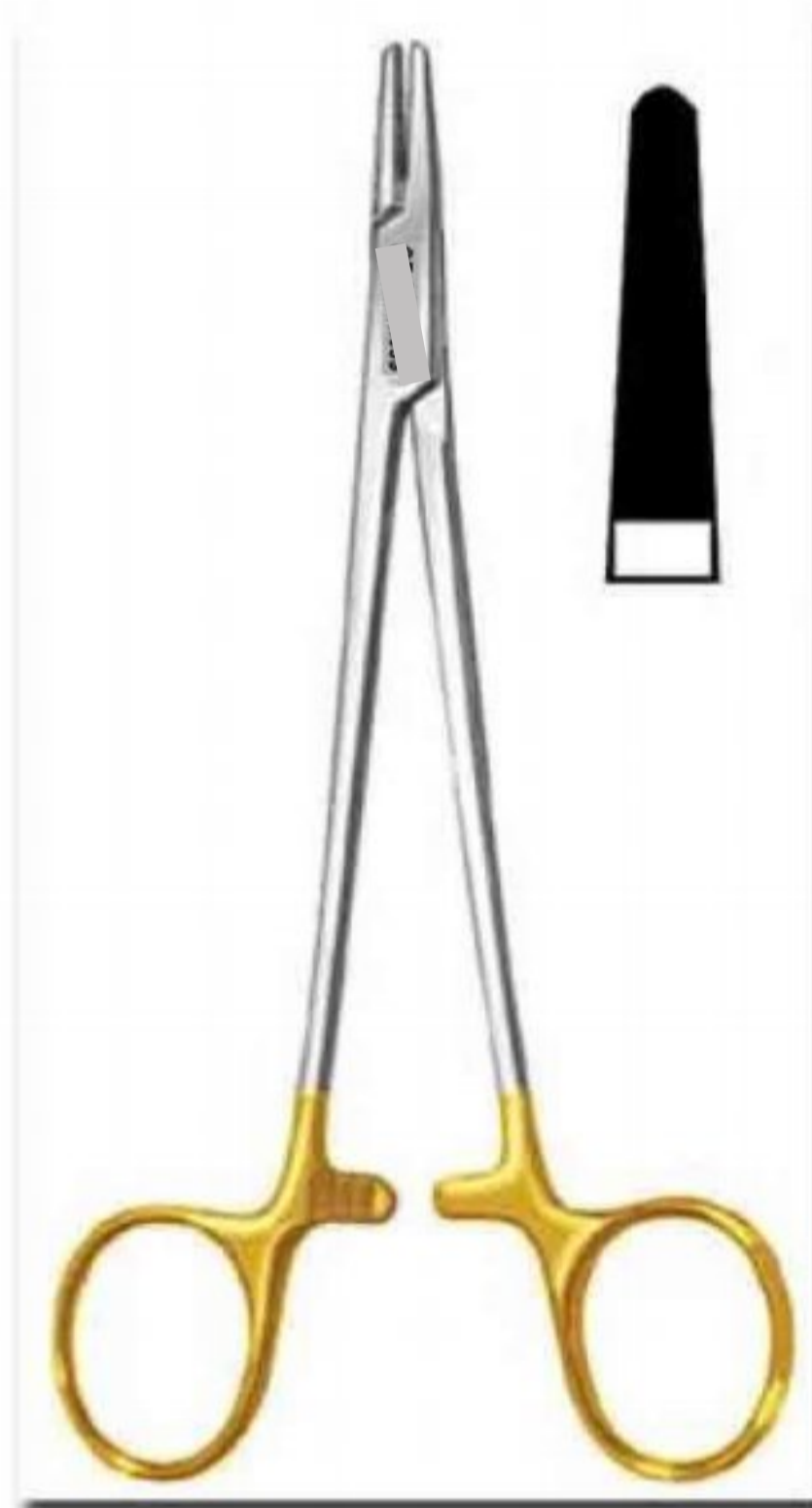

AJ-2619
Wire Twisting Forceps
16 cm / 6 1/4"



AJ-2620 Wire Twisting Forceps Heavy Pattern
19 cm / 7 1/2"

The Corwin-Hegar automatic Wire Twister is a special automatic twisting Instrument. In combination with a cerclage wire it can be used for fixation of fractures or temporal fixation. The Automatic Wire Twisters are available in different lengths and with various tungsten carbide inserts.



AJ-2621 Corwin-Hegar
Auto Wire Twisting Forceps
15 cm / 6"



AJ-2622

Jet Wire Twisting Device
28 cm / 11" - 10mm Tip

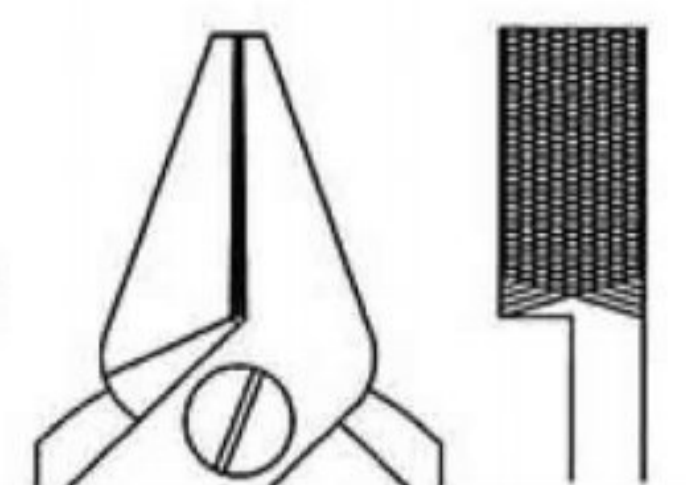

CARBIDE INSERTED SURGICAL SCISSORS

Scissors in this Section can also be Manufactured without Carbide Tips / Gold Plating

AJ-2623

Mayo
Scissors TC Gold
A: 14.5 cm / 5 3/4" Str or Cvd
B: 17 cm / 6 3/4" Str or Cvd
C: 23 cm / 9" Str or Cvd

Blunt / Blunt

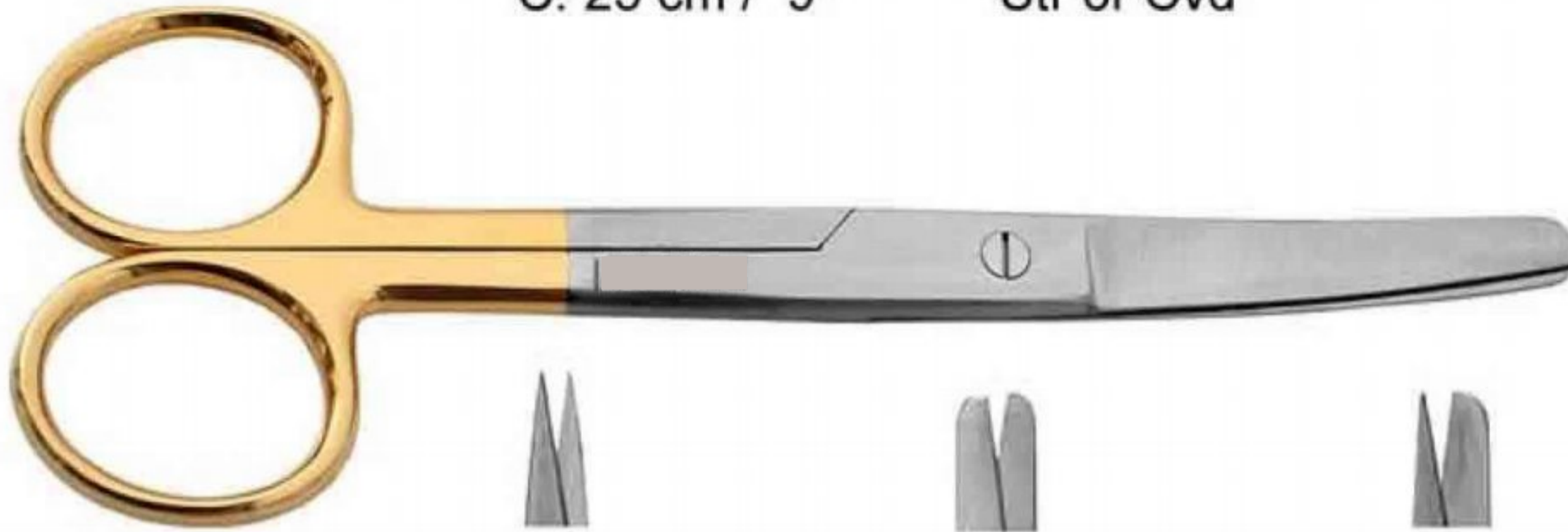
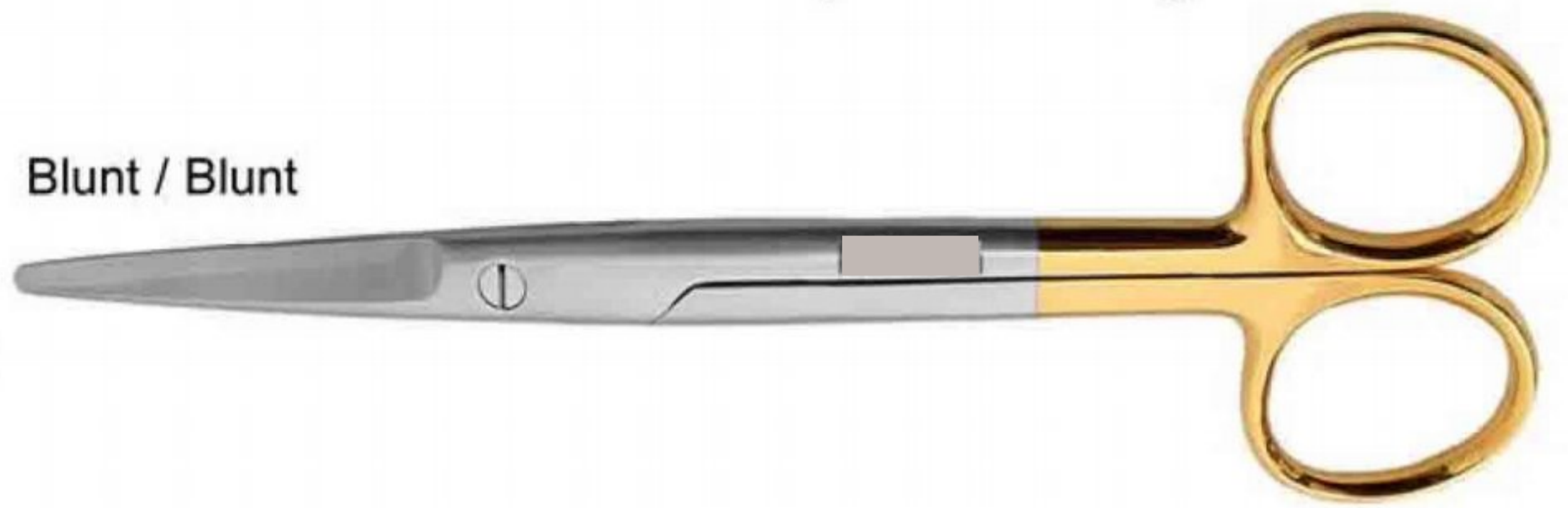

AJ-2624

Operating (Standard)
Scissors TC Gold

A: 13 cm / 5" Str or Cvd
B: 14 cm / 5 1/2" Str or Cvd
C: 15.5 cm / 6 1/2" Str or Cvd
D: 18 cm / 7" Str or Cvd

Sharp / Sharp
Cvd or Str



Blunt / Blunt
Cvd or Str



Sharp / Blunt
Cvd or Str



Please Mention Above Styles When Ordering Standard TC Scissors

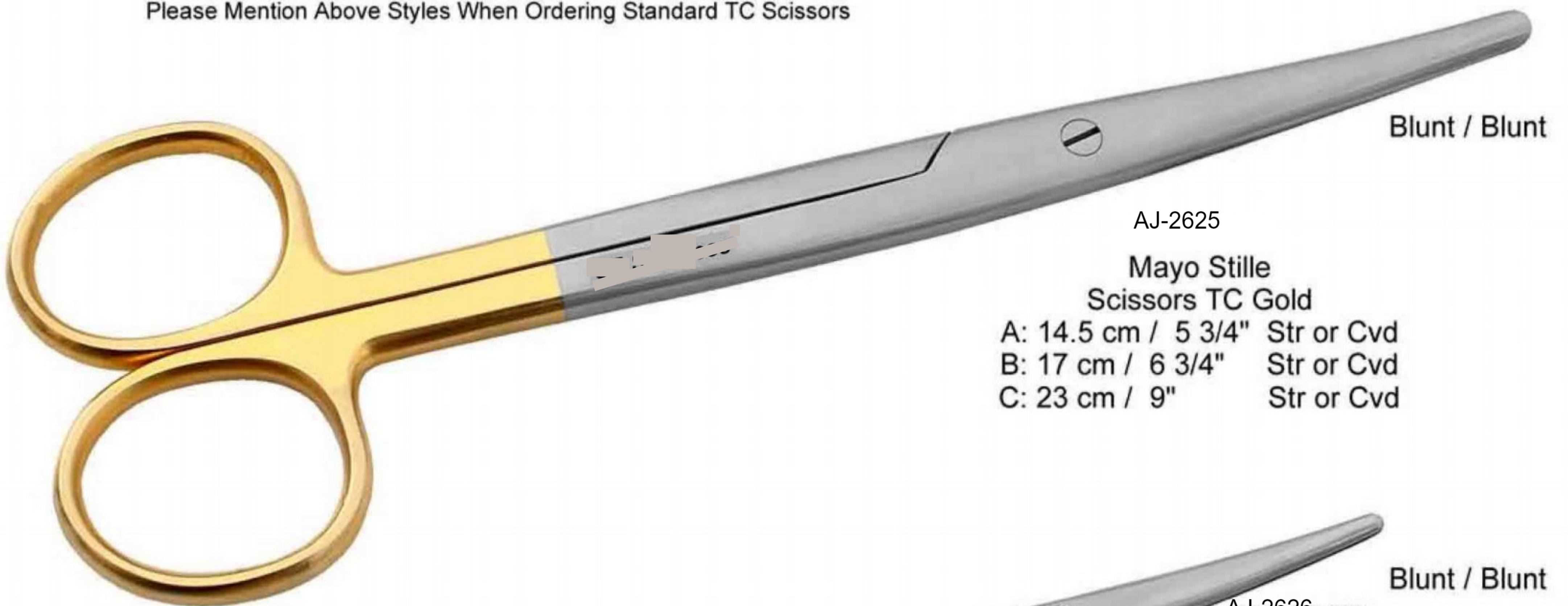

AJ-2625

Mayo Stille
Scissors TC Gold

A: 14.5 cm / 5 3/4" Str or Cvd
B: 17 cm / 6 3/4" Str or Cvd
C: 23 cm / 9" Str or Cvd

Blunt / Blunt

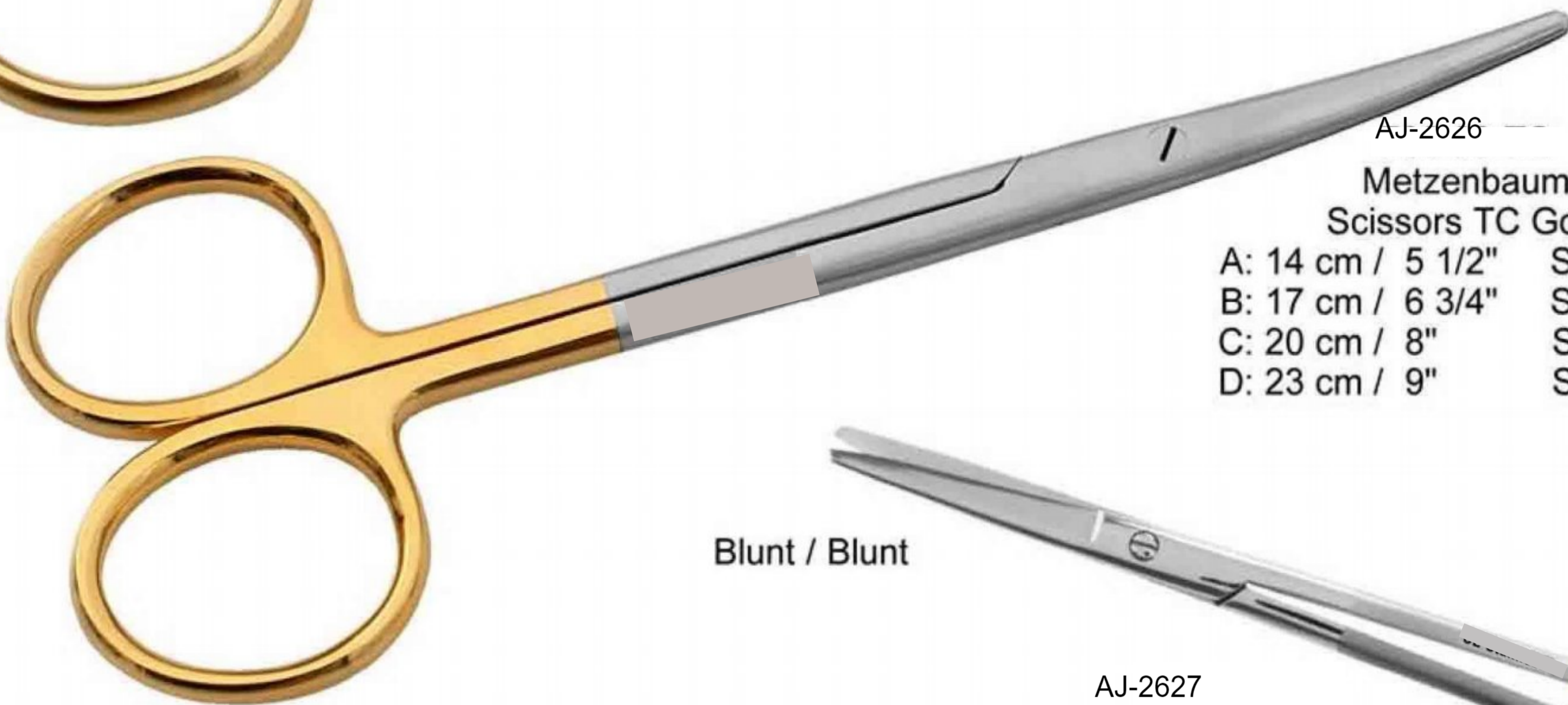

AJ-2626

Metzenbaum
Scissors TC Gold

A: 14 cm / 5 1/2" Str or Cvd
B: 17 cm / 6 3/4" Str or Cvd
C: 20 cm / 8" Str or Cvd
D: 23 cm / 9" Str or Cvd

Blunt / Blunt

Blunt / Blunt



AJ-2627

Mayo-Harrington
Scissors TC Gold

A: 20 cm / 8" Str or Cvd
B: 23 cm / 9" Str or Cvd
C: 28 cm / 11" Str or Cvd
D: 30 cm / 12" Str or Cvd

AJ-2628

Ortho Universal Scissors TC Gold
12 cm / 4 1/3"



AJ-2629

Mayo-Nobel
Scissors TC Gold
A: 16.5 cm / 6 1/2"
Str or Cvd

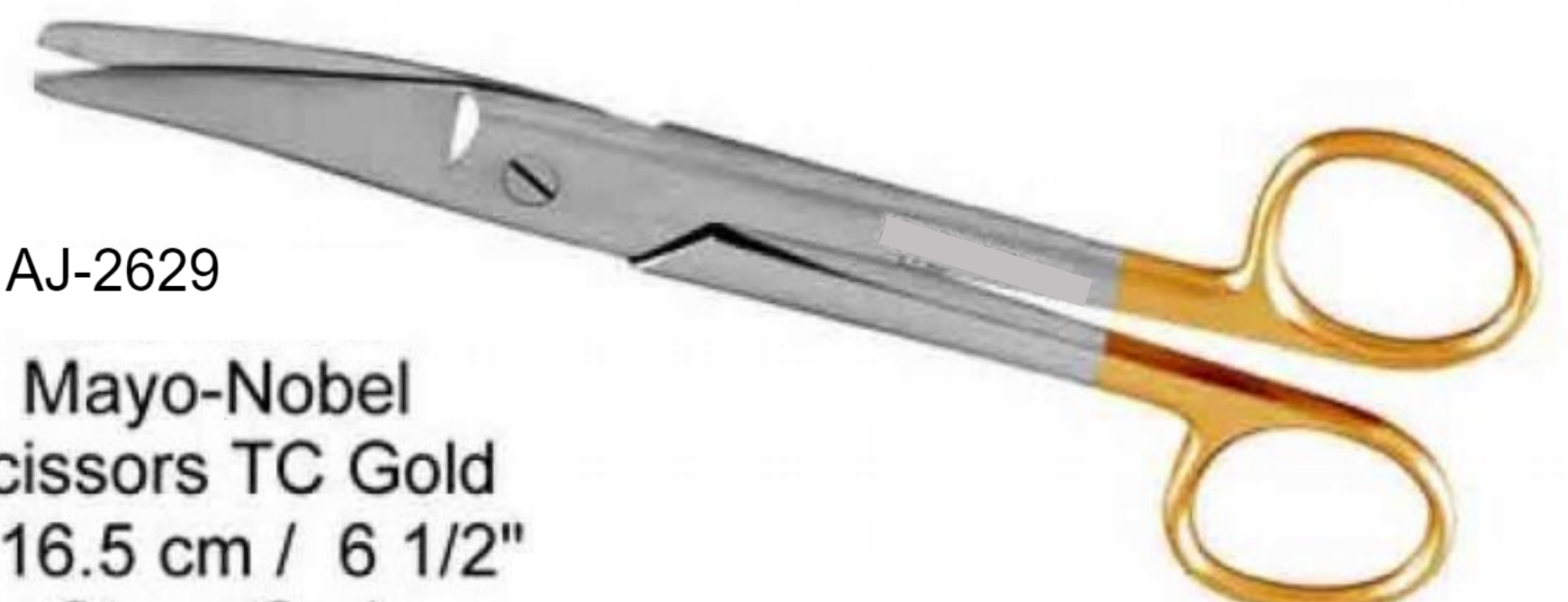

CARBIDE INSTERTED WIRE & PIN CUTTERS

AJ-2630

Wire Cutting Plier TC Gold
A: 15 cm / 6" Cut Upto 1.3mm
B: 18 cm / 7" Cut Upto 1.6mm
C: 23 cm / 9" Cut Upto 2.5mm

Angled



AJ-2631

Wire Cutting Plier TC Gold
A: 15 cm / 6" Cut Upto 1.3mm
B: 18 cm / 7" Cut Upto 1.6mm

AJ-2632

Wire Cutting Plier TC Gold
23 cm / 9" Cut Upto 2.5mm

AJ-2633

Wire Cutting Plier TC Gold
18 cm / 7" Cut Upto 1.6mm

CARBIDE INSTERTED WIRE & PIN CUTTERS

AJ-2634

Cannulated Pin Cutter TC Gold
18 cm / 7" Cut Upto 1.5mm



AJ-2635

Front End
Wire Cutting Plier
TC Gold
15 cm / 6"
Cut Upto 1.3mm



AJ-2636

Front End
Wire Cutting Plier
TC Gold
23 cm / 9"
Cut Upto 2.5mm

AJ-2637

Front End
Wire Cutting Plier
TC Gold
23 cm / 9"
Cut Upto 2.5mm



CARBIDE INSTERTED PIN & PLATE CUTTERS

AJ-2638

Plate / Pin Cutting Plier
TC Gold
23 cm / 9"
Cut Upto 3.0mm



AJ-2639

Pin / Wire Cutting Plier
TC Gold / Adjustable
23 cm / 9"
Cut Upto 2.5mm

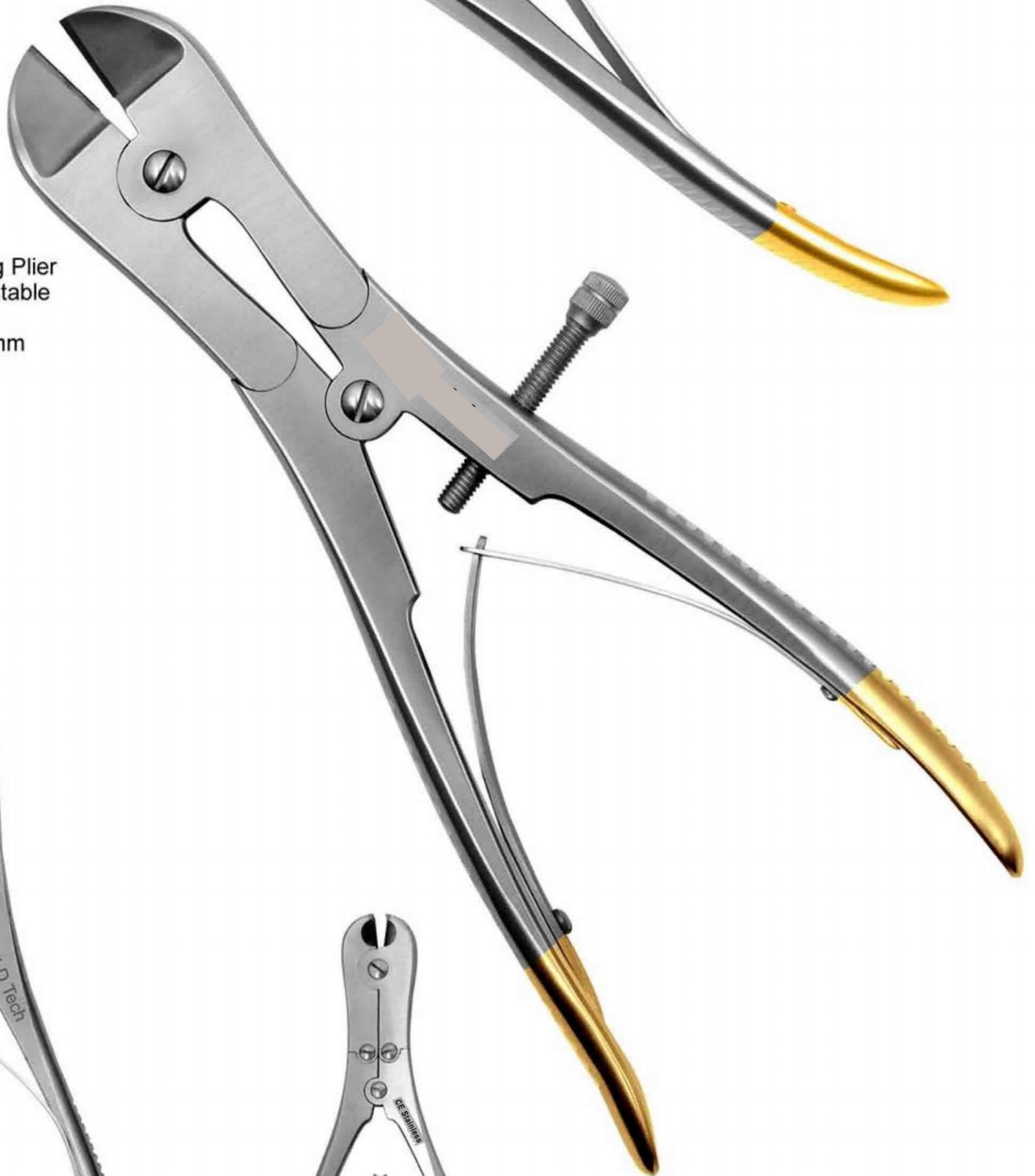

AJ-2640

Pin / Wire Cutting Plier
TC Gold
23 cm / 9"
Cut Upto 2.5mm

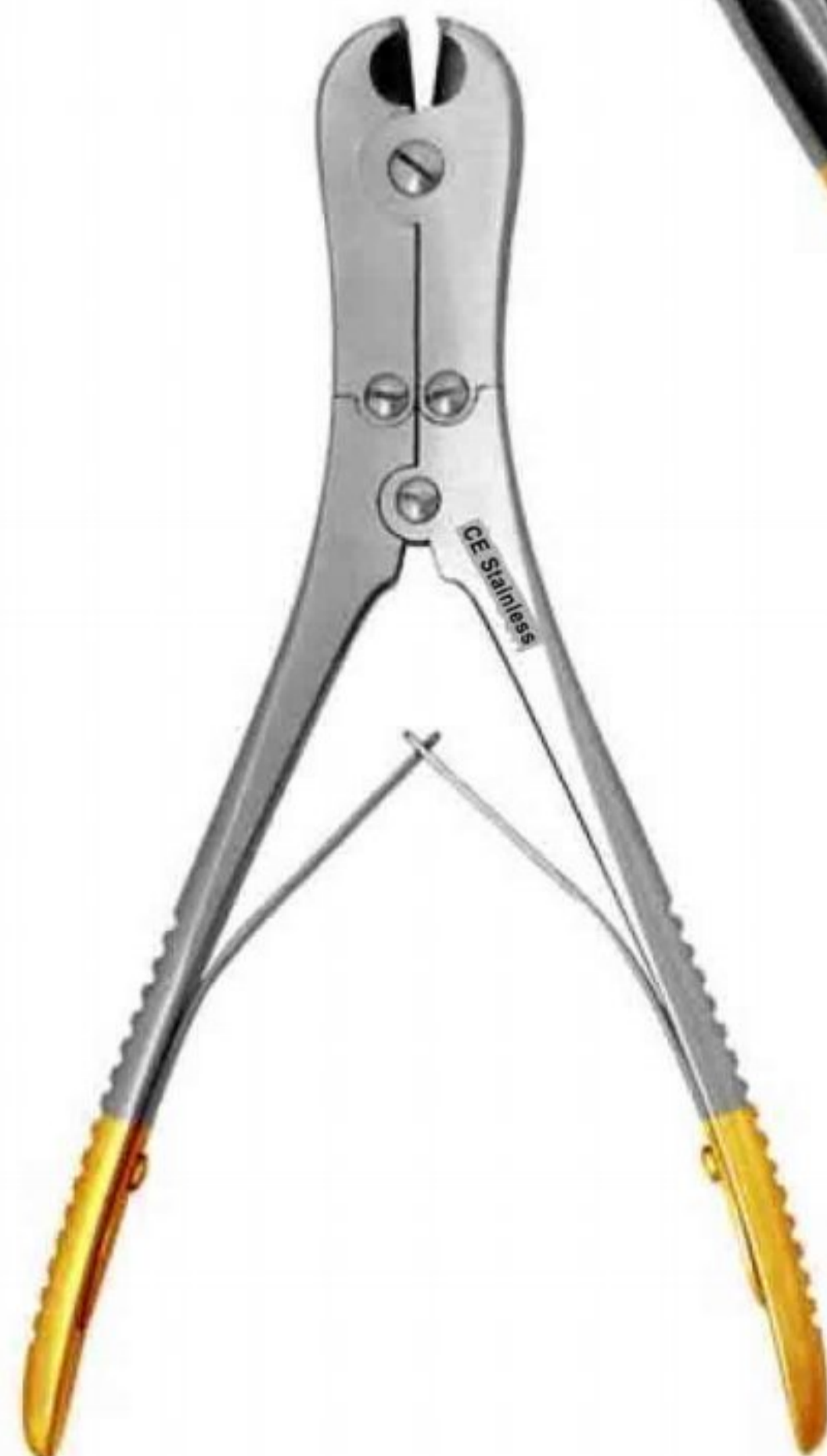

AJ-2641

Front / Side
Wire Cutting Plier
TC Gold
18 cm / 7"
Cut Upto 1.6mm

CARBIDE INSTERTED PIN CUTTERS HEAVYDUTY



AJ-2642

Heavy Duty
Pin Cutting Plier
TC Gold

- A: 30 cm / 12" Cut Upto 3mm
- B: 47 cm / 18 1/2" Cut Upto 5mm
- C: 56 cm / 22" Cut Upto 6mm
- D: 60 cm / 24" Cut Upto 7mm



AJ-2643

Heavy Duty
Pin End Cutting Plier
TC Gold

- A: 27 cm / 10 1/2" Cut Upto 3mm
- B: 38 cm / 15" Cut Upto 4mm

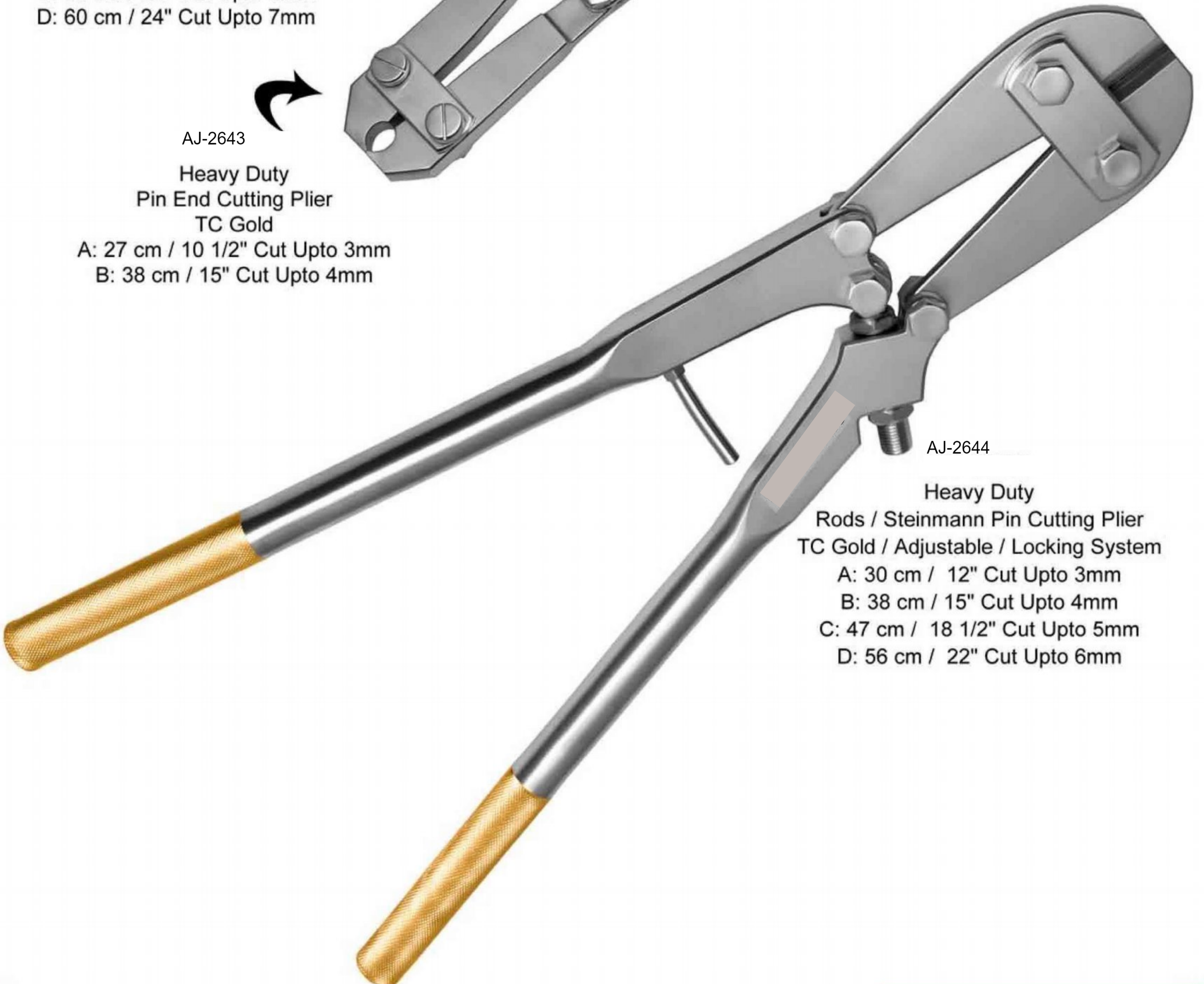
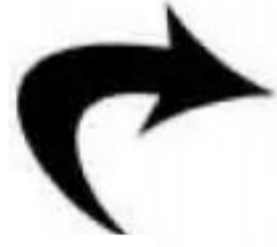

AJ-2644

Heavy Duty
Rods / Steinmann Pin Cutting Plier
TC Gold / Adjustable / Locking System

- A: 30 cm / 12" Cut Upto 3mm
- B: 38 cm / 15" Cut Upto 4mm
- C: 47 cm / 18 1/2" Cut Upto 5mm
- D: 56 cm / 22" Cut Upto 6mm

INSTRUMENTS FOR TRUAMATOLOGY



Drill Bits for Quick Coupling

Drill bit 1.1mm dia
for threaded hole for 1.5mm screws

Drill bit 1.5mm dia.
For threaded hole for 2.0mm screws and gliding hole for 1.5mm screws

Drill bit 2.0mm dia.
For threaded hole for 2.7 mm dia.
For gliding hole for 2.7mm screws

| Item | Diameter | Total length | Usable length |
|---------|----------|--------------|---------------|
| AJ-2645 | 1.1mm | 060mm | 035mm |
| AJ-2646 | 1.5mm | 085mm | 060mm |
| AJ-2647 | 1.5mm | 110mm | 085mm |
| AJ-2648 | 2.0mm | 100mm | 145mm |
| AJ-2649 | 2.0mm | 125mm | 100mm |
| AJ-2650 | 2.7mm | 100mm | 075mm |
| AJ-2651 | 2.7mm | 125mm | 100mm |
| AJ-2652 | 2.7mm | 100mm | 075mm |
| AJ-2653 | 2.0mm | 125mm | 100mm |

Drill bit 2.5mm dia.
For threaded hole for 3.5 and 4.0mm screws

| Item | Diameter | Total length | Usable length |
|---------|----------|--------------|---------------|
| AJ-2668 | 2.5mm | 110mm | 085mm |
| AJ-2669 | 2.5mm | 180mm | 155mm |
| AJ-2670 | 3.5mm | 100mm | 085mm |
| AJ-2671 | 3.5mm | 195mm | 170mm |

Drill bit 3.2mm dia.
For threaded hole for 4.5 and 6.5mm screws

| Item | Diameter | Total length | Usable length |
|---------|----------|--------------|---------------|
| AJ-2677 | 2.0mm | 100mm | 145mm |
| AJ-2678 | 3.2mm | 225mm | 200mm |
| AJ-2679 | 3.2mm | 145mm | 120mm |
| AJ-2680 | 3.2mm | 195mm | 170mm |
| AJ-2681 | 4.5mm | 145mm | 120mm |
| AJ-2682 | 4.5mm | 195mm | 170mm |



Drill Bits for Jacobs Type Chuck

Drill Bit for Jacobs chuck

| Item | Diameter | Total length | Usable length |
|---------|----------|--------------|---------------|
| AJ-2654 | 1.1mm | 45mm | 30mm |
| AJ-2655 | 1.5mm | 70mm | 55mm |
| AJ-2656 | 2.0mm | 85mm | 70mm |
| AJ-2657 | 2.5mm | 095mm | 080mm |
| AJ-2658 | 2.7mm | 85mm | 70mm |
| AJ-2659 | 3.2mm | 130mm | 115mm |
| AJ-2660 | 3.2mm | 180mm | 165mm |
| AJ-2661 | 3.5mm | 095mm | 080mm |
| AJ-2662 | 3.5mm | 180mm | 165mm |
| AJ-2663 | 4.5mm | 130mm | 115mm |
| AJ-2664 | 4.5mm | 180mm | 165mm |



Tap for 2.0mm Cortex Screws
Predrilling: 1.5mm dia.

| Item | Thread length | Total length |
|---------|---------------|--------------|
| AJ-2672 | 24mm | 053mm |
| AJ-2673 | 38mm | 100mm |

Predrilling: 3.2mm

| Item | Length | Type |
|---------|--------|----------------------|
| AJ-2674 | 125mm | thread length 70mm |
| AJ-2675 | 175mm | with length markings |

AJ-2676

Tap for 3.5mm Cortex Screws
total length 110mm, thread length 50mm
predrilling: 2.5mm dia.

Tap for 2.7mm Cortex Screws
Predrilling: 2.0mm dia.

| Item | Thread length | Total length |
|---------|---------------|--------------|
| AJ-2683 | 33mm | 100mm |
| AJ-2684 | 40mm | 150mm |

AJ-2685

Tap for 2.7mm Cortex Screws
total length 125mm, thread length 40mm
predrilling: 2.0mm dia.

Tap for 3.5mm Cortex Screws
Predrilling: 2.5mm dia.

| Item | Total length | Type |
|---------|--------------|----------------------|
| AJ-2686 | 175mm | with length markings |
| AJ-2687 | 110mm | thread length 50mm |

AJ-2688

Tap for 4.5mm Cortex Screws
total length 125mm, thread length 70mm
predrilling: 3.2mm dia.



AJ-2689
Countersink Shaft 1.5/2.0
length 52mm, for mini quick coupling



AJ-2697
Handle with quick coupling
length 110mm
for countersinks and
instruments for the removal of damaged screws



AJ-2704
Screwdriver Shaft, hexagonal, small
length 100mm, for quick coupling
For 2.7 to 4.0mm screws.



AJ-2710
Screwdriver Shaft, Hexagonal, large
length 100mm,
Final tightening of the screw has to
be done by hand.



AJ-2690
Router, for Jacobs chuck
length 90mm



AJ-2698
T-Handle with quick coupling
length 80mm, for taps



AJ-2705
Screwdriver Shaft, hexagonal, with Holding Sleeve
for 1.5 and 2.0mm stainless steel screws
with hexagonal socket,



AJ-2711
Screwdriver Shaft, cruciform, 1.5/2.0, with Holding Sleeve
length 50mm, for 1.5 and 2.0mm



AJ-2691
Router, for quick coupling
length 90mm



AJ-2692
Countersink, large
length 180mm, for 4.5mm cortex screws



AJ-2699
Handle, small, with mini quick coupling



AJ-2706
Screwdriver, hexagonal, with T-Handle,
large to loosen tight screws.
A normal screwdriver can be
additionally inserted in the hollow
shaft of the T-handle.



AJ-2712
Screwdriver, hexagonal, small with groove
length 200mm, for 2.7 to 4.0mm screws



AJ-2693
Countersink Shaft 3.5mm
length 72mm, for quick coupling,
to countersink the screw head



AJ-2700
Handle, medium, with mini quick coupling



AJ-2707
Screwdriver with Universal Joint, large
length 290mm



AJ-2713
Screwdriver, hexagonal, large, with groove
length 240mm



AJ-2694
Countersink, cannulated, for 7.0mm Cannulated Screws
length 230mm



AJ-2701
Handle, large, with mini quick coupling



AJ-2708
Screwdriver, hexagonal, with Holding Sleeve,
length 165mm for 1.5 and 2.0mm stainless
steel screws with hexagonal socket



AJ-2714
Screwdriver, hexagonal, small, with Holding Sleeve
length 200mm



AJ-2695
Handle with mini quick coupling



AJ-2702
Allen Key, hexagonal, angled
for 4.5 to 7.0mm screws



AJ-2709
Holding Sleeve



AJ-2715
Holding Sleeve for no. 314.030
single, as spare



AJ-2716
Holding Sleeve for Mini Screws
single



AJ-2696
Hand Chuck for Kirschner Wires
length 145mm, Spannbereich 0.6 to 1.6mm dia.



AJ-2703
Allen Key, hexagonal, small, angled
length 65mm, for 2.7 to 4.0mm screws

INSTRUMENTS FOR TRUAMATOLOGY



AJ-2717
Insert Drill Sleeve 3.5/2.5
length 42mm, drill bit 2.5mm dia.



AJ-2718
Insert Drill Sleeve 4.5/3.2
length 80mm
for long lag screws



AJ-2719
Trocar 2.0mm dia.
Length 118mm, for percutaneous insertion of 7.0mm cannulated screws



AJ-2720
Drill Sleeve 4.5/2.0
length 109mm, for percutaneous insertion of 7.0mm cannulated screws



AJ-2721
Drill Sleeve 8.0/4.5
length 100mm, for percutaneous insertion of 7.0mm cannulated screws



AJ-2722
Handle for Drill Guides
single



AJ-2723
Drill Sleeve 3.0 with point
length 55mm



AJ-2724
Handle for Drill Guides
for nos. 397.150 to 170.single

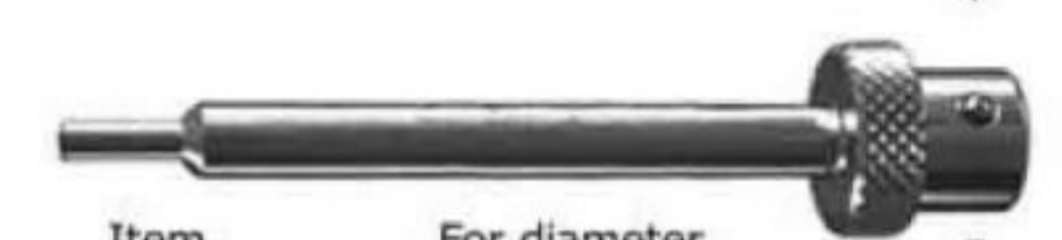

| Item | For diameter |
|---------|--------------|
| AJ-2725 | 1.5mm |
| AJ-2726 | 2.0/2.7mm |



AJ-2727
Drill Sleeve 2.7



AJ-2728
Double Drill Sleeve 1.5/101
for 1.5mm cortex screws
drill bits, 1.5 and 1.1mm dia



AJ-2729
Double Drill Sleeve 2.0/1.5
for 2.0mm cortex screws



AJ-2730
Double Drill Sleeve 2.7/2.0
for 2.7mm cortex screws



AJ-2731
Double Drill Sleeve 3.5/2.5
for 3.5mm cortex screws and 4.0mm cancellous
bone screws
drill bits 3.5 and 2.5 dia.,



AJ-2732
Double Drill Sleeve 4.5/3.2
for 4.5mm cortex screws
drill bits: 4.5 and 3.2mm dia



AJ-2733
Double Drill Sleeve 6.5/3.2
for 6.5mm cancellous bone screws
drill bit: 3.2mm dia.

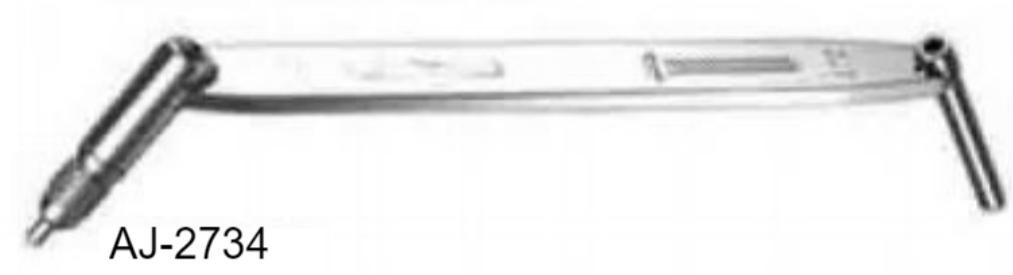

AJ-2734
Universal Drill Sleeve 2.7
Drill bits 2.0 and 2.7mm dia.,
Suitable for LC-DCP and round hole plates.



AJ-2735
Universal Drill Guide 3.5
Drill bit 2.5 and 3.5mm dia., And tissue protection
for taps nos.
311.310/320/340, Suitable for LC-DCP and
round hole plates.



AJ-2736
Universal Drill Guide 4.5/3.2
Drill bits 3.2 and 4.5mm dia.



AJ-2737
DCP Drill Guide 2.0
for neutral and load position
drill bit 1.5mm dia.



AJ-2738
DCP Drill Guide 2.7
for neutral and load position
drill bit 2.0mm dia.



AJ-2738
DCP Drill Guide 3.5
for neutral an load position, drill bit 2.5mm dia.



AJ-2739
DCP Drill Guide 4.5
for neutral and load position, drill bit 3.2mm dia.



AJ-2740
LC-DCP Drill Guide 3.5
for neutral an load position, drill bit 2.5mm dia.

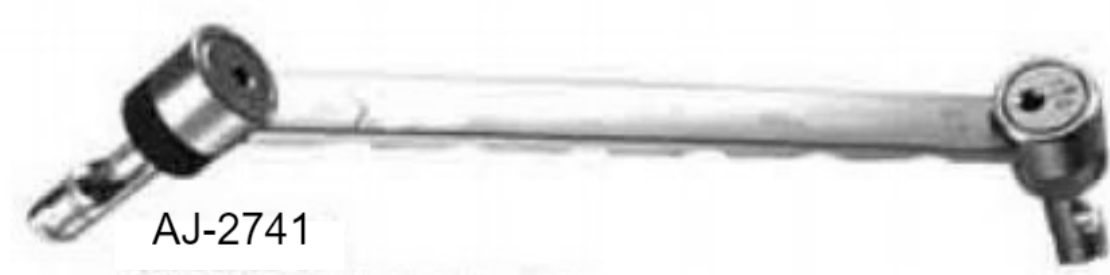

AJ-2741
LC-DCP Drill Guide 4.5
for neutral and load position, drill bit 3.2mm dia.



AJ-2742
DCP Hip Drill Guide 4.5
for neutral and load position, for 4.5mm screws with DHS and
angled blade plates, sleeve length 60mm, drill bit 3.2mm dia.



AJ-2743
Triple Drill Sleeve 2.0
with 3 holes, opposite side 1 hole



AJ-2744
DCP Mandible Drill Guide 2.7 short
drill bit 2.0mm dia



AJ-2745
DCP Mandible Drill Guide 2.7 long
drill bit 2.0mm dia



AJ-2746
Insert Drill Sleeve wit stop, for 4.5mm screws
adjustable length to limit drilling depth,
external dia. 4.5mm for drill bits of 3.2mm dia.



AJ-2747
Parallel drill Guide 4.5
for percutaneous insertion of 7.0mm cannulated screws



AJ-2748
Parallel Wire Guide 2.0mm dia.



AJ-2749
Depth Gauge for 2.7 to 4.0m screws
measuring range up to 60mm



AJ-2750
Depth Gauge for 2.7 to 4.0mm screws
measuring range up to 60mm



AJ-2751
Depth Gauge for 4.5mm to 6.5mm screws
measuring range up to 110mm



| Item | Slid placement |
|---------|----------------|
| AJ-2752 | 4.5/2.5mm |
| AJ-2753 | 2.5/4.5mm |



| Item | Length | Slid width |
|---------|--------|------------|
| AJ-2754 | 130mm | 2.5mm |



AJ-2755
Triple Drill Guide
130° angle, for 130° angled blade plates and
for condylar plates,
drill bit 4.5mm dia.



AJ-2756
Drill Guide with stop 3.5/2.7
to limit drilling depth



AJ-2757
Protection Sleeve 11.0/8.0
for percutaneous insertion of 7.0mm cannulated screws



AJ-2758
Holding Sleeve
length 80mm, for 2.7 to 4.0mm screws



AJ-2759
Holding Sleeve for
lengt 80mm for 2.7mm screws and
3.5mm cannulated screws



AJ-2760
Holding Sleeve, large, length 120mm
for Nos. 314.190/240/260/270/275



AJ-2761
Screw Forceps, self-holding
length 85mm, to take screws out of the screw racks

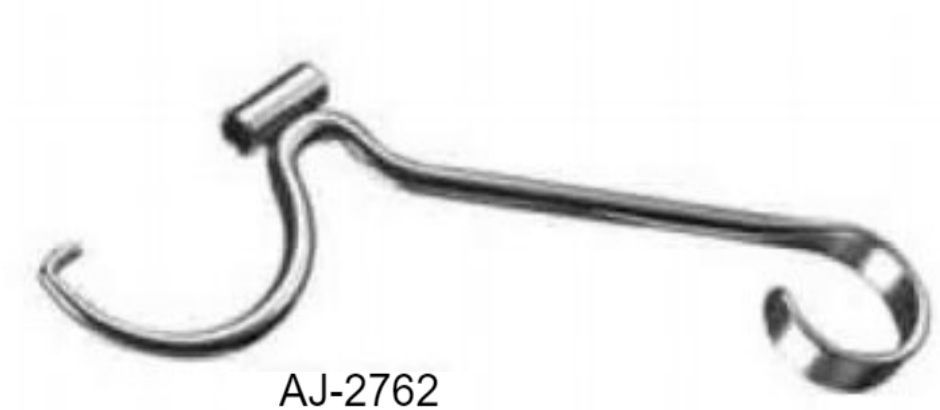

AJ-2762
Drill Sleeve, pointed



AJ-2763
Bending Iron LC-DCP/DCP
length 250mm, for small and broad LC-DCP, DCP
slit widths 5 and 7mm, Required in pairs

INSTRUMENTS FOR TRUAMATOLOGY



AJ-2764
Bending Iron for Kirschner Wires
length 120mm, for 1.25 to 2.5mm dia.



AJ-2765
Bending Iron for Kirschner Wires
length 115mm, for 0.8 to 1.25mm dia.



AJ-2766
Bending Iron for Reconstruction Plates 3.5 and 4.5
length 190mm, required in paris



AJ-2767
Handle with Sleeve
with rotating drill guide and anchoring point



AJ-2768
Trocar Point, large, for number 397.110
for nos. 387.000/397.110



AJ-2769
Cheek Retractor Ring, for number 397.110
for nos. 387.000/397.110



AJ-2770
Combination Wrench 11mm
length 140mm



AJ-2771
Pin Wrench
length 120mm, 4.5mm dia.
For tension device, distractor and knurled
nut of insertion handle for intramedullary nail



AJ-2772
Socket Wrench 11mm
length 200mm



AJ-2773
Slotted Hammer
length 270mm



AJ-2774
Inserter/Extractor, with Adjustable Clamps
length 270mm, for the insertion and extraction of angled plates for
adults and hip plates for adolescents and children as well as tibial
plateau osteotomy plates.



AJ-2775
Inserter/Extractor
length 175mm, for infant hip plate and mini hip plate.



AJ-2776
Bending Pliers for Reconstruction Plates 2.7 and 3.5
length 240mm



AJ-2777
Bending Pliers for plate 2.4 to 4.0
length 230mm



AJ-2778
Bending Pliers for plates



AJ-2779
Anvil, narrow



AJ-2780
Anvil, large



AJ-2781
Bending Press
length 400mm



AJ-2782
Cutter for thin plates 1.5 to 2.7
length 256mm



AJ-2783
Bending Pliers
for reconstruction plates 2.7,
length 270mm, required in paris



AJ-2784
Cerclage Wire Tightener
length 260mm
for twisting, for temporary fixation during reduction



AJ-2785
Tension Device, articulated
Span 20mm, can also be used as a distractor.
Colour scale: yellow up to 500N, green up to 1000N,
red above 1000N.



AJ-2786
Chisel Guide
with adjustable angle

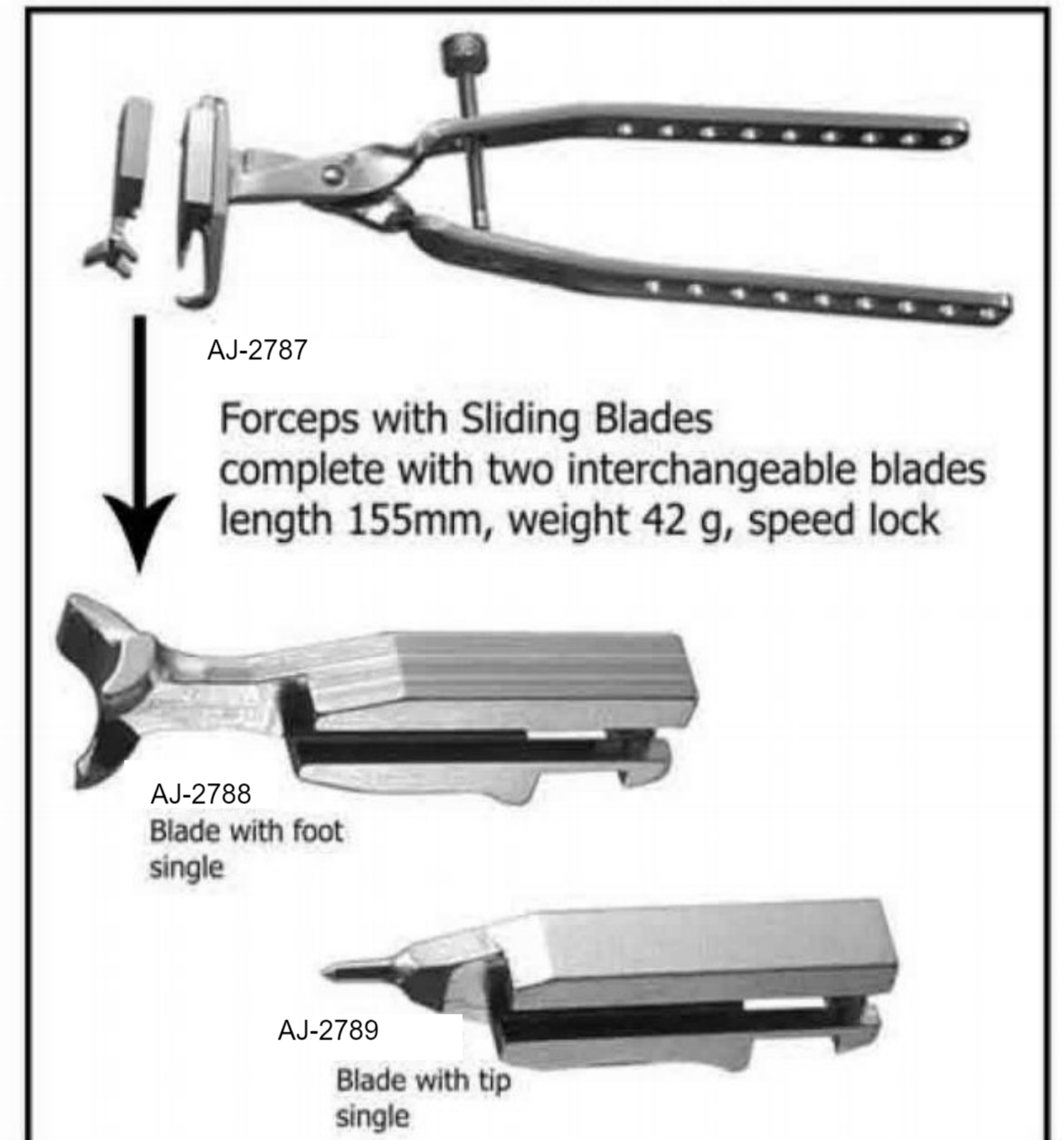

AJ-2787
Forceps with Sliding Blades
complete with two interchangeable blades
length 155mm, weight 42 g, speed lock



AJ-2788
Blade with foot
single

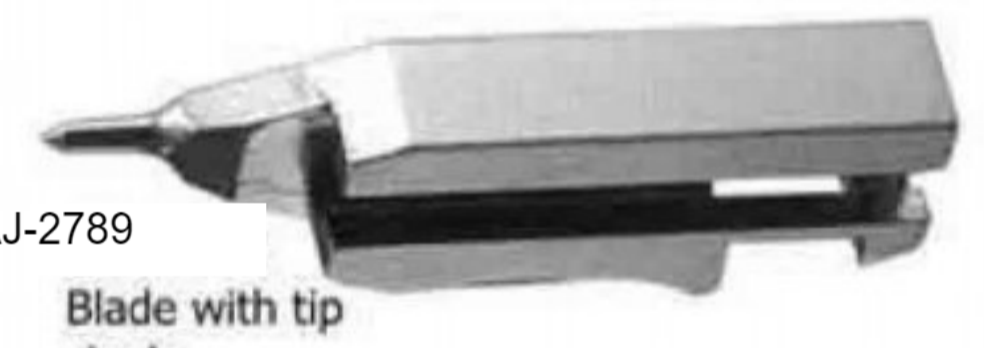

AJ-2789
Blade with tip
single



AJ-2790
Measuring Device
for drill bits, screws, Kirschner wires, and Steinmann pins



AJ-2791
Holding Clip



AJ-2792
Wire Passer
45mm bending diameter



AJ-2793
Wire Passer
70mm bending diameter



AJ-2794
Wire Tightener
length 240mm, with handle and two pegs

INSTRUMENTS FOR TRUAMATOLOGY



Cerclage Wire with eye
Packs of 10 Wires

| Item | Diameter | Length |
|----------|----------|--------|
| AJ-2815A | 0.80mm | 280mm |
| | 1.00mm | 280mm |
| | 1.25mm | 280mm |
| | 1.00mm | 600mm |
| | 1.25mm | 600mm |
| | 1.50mm | 280mm |
| | 1.50mm | 600mm |

Cerclage Wires without eye
In precut lengths
packs of 10 wires

| Item | Diameter | Length |
|------|----------|--------|
| | 0.40mm | 150mm |
| | 0.60mm | 175mm |
| | 0.80mm | 200mm |
| | 1.00mm | 250mm |
| | 1.25mm | 300mm |

Diameter Ø

- A: 0.2 mm
- B: 0.3 mm
- C: 0.4 mm
- D: 0.5 mm
- E: 0.6 mm
- F: 0.7 mm
- G: 0.8 mm
- H: 0.9 mm
- I: 1.0 mm
- J: 1.2 mm
- K: 1.5 mm

AJ-2823
Bone Wire Soft
Coil of 10 Meters
Implantable Material

Shanz Screws
Implantable Material

| | |
|-----------------|-----------------|
| 2 x 60 x 15 mm | 5 x 150 x 30 mm |
| 3 x 60 x 15 mm | 5 x 160 x 40 mm |
| 3 x 80 x 15 mm | 5 x 180 x 40 mm |
| 3 x 80 x 20 mm | 5 x 200 x 40 mm |
| 3 x 100 x 15 mm | 5 x 220 x 40 mm |
| 3 x 120 x 15 mm | 6 x 120 x 40 mm |
| 4 x 80 x 20 mm | 6 x 140 x 40 mm |
| 4 x 100 x 20 mm | 6 x 150 x 40 mm |
| 4 x 120 x 20 mm | 6 x 160 x 40 mm |
| 4 x 140 x 20 mm | 6 x 180 x 40 mm |
| 5 x 120 x 30 mm | 6 x 200 x 40 mm |
| 5 x 140 x 30 mm | 6 x 220 x 40 mm |

Kirschner Wire
Implantable Material

| Packs of 10 units | | Diameter | Length | Titanium Alloy |
|-------------------|-----------|----------|--------|----------------|
| AJ-2824 | St. steel | 0.60mm | 070mm | 492.060 |
| AJ-2825 | | 0.80mm | 070mm | 492.080 |
| AJ-2826 | | 0.80mm | 150mm | 492.090 |
| AJ-2827 | | 1.00mm | 150mm | 492.100 |
| AJ-2828 | | 1.00mm | 280mm | 492.110 |
| AJ-2829 | | 1.25mm | 150mm | 492.120 |
| AJ-2830 | | 1.25mm | 280mm | 492.130 |
| AJ-2831 | | 1.40mm | 150mm | 492.140 |
| AJ-2832 | | 1.40mm | 280mm | 492.150 |
| AJ-2833 | | 1.60mm | 150mm | 492.160 |
| AJ-2834 | | 1.60mm | 280mm | 492.170 |
| AJ-2835 | | 1.80mm | 150mm | 492.180 |
| AJ-2836 | | 1.60mm | 280mm | 492.180 |

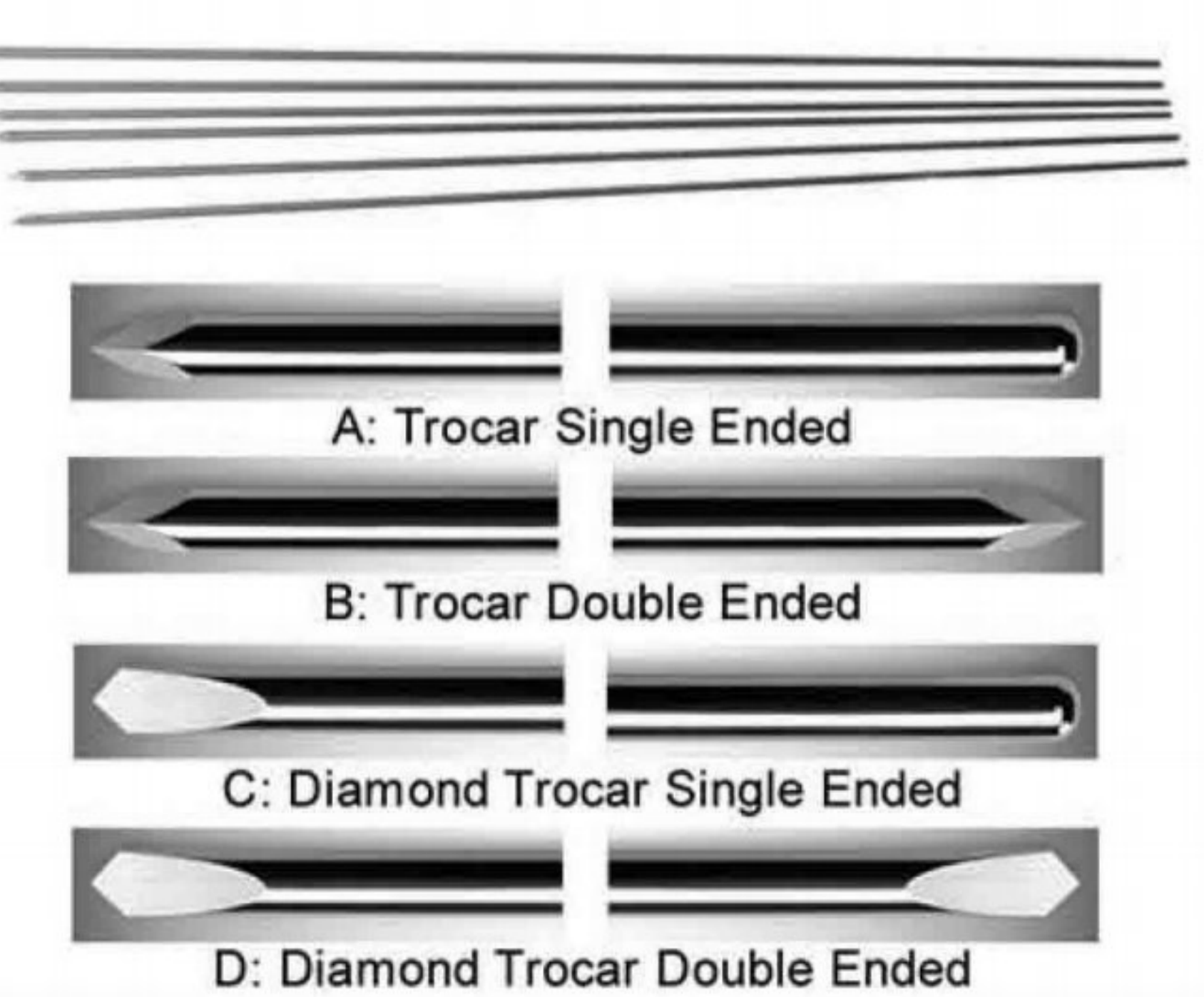

Kirschner Wire
Implantable Material

| Packs of 10 units | | | |
|-------------------|----------|--------|----------------|
| St. steel | Diameter | Length | Titanium Alloy |
| AJ-2837 | 1.80mm | 280mm | 492.190 |
| AJ-2838 | 2.00mm | 150mm | 492.200 |
| AJ-2839 | 2.00mm | 280mm | 492.210 |
| AJ-2840 | 2.00mm | 400mm | 492.230 |
| AJ-2841 | 2.50mm | 150mm | 492.250 |
| AJ-2842 | 2.50mm | 280mm | 492.260 |
| AJ-2843 | 2.50mm | 400mm | 492.280 |
| AJ-2844 | 3.00mm | 150mm | 492.300 |
| AJ-2845 | 3.00mm | 280mm | 492.310 |
| AJ-2846 | 3.00mm | 400mm | 492.330 |